

Save Big on Alignment Combos

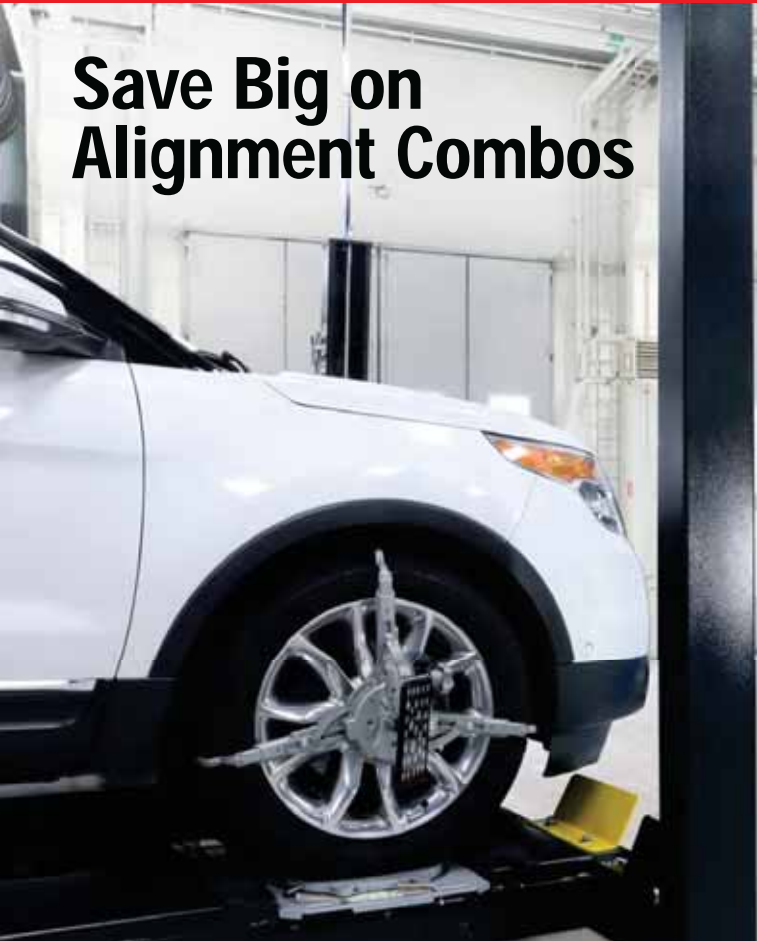

HOFMANN[®]



geoliner[®] 678
Complete Alignment System with 12,000 Lb. 4 Post Lift

SKU OSB | ALIGNCOMB027

45,999⁹⁹

SAVE*
\$2,099

geoliner[®] 678 Wheel Alignment System with AC400 & VIN
HOFA715TBV3

12,000 Lb. 4 Post Alignment Lift
HOFEELR728APKG

Includes 2 Rolling Jacks and Airline Kit

See Page 86 for More Savings

*Combo savings based on the price of items if purchased separately.

energylogic[™]

Stop paying to have your waste oil hauled off!
Save and burn it for FREE heat this winter.



Not for sale in CA

See Page 17 for New Low Prices on Our Complete List of Waste Oil Heaters

Truck Tire Step

SKU 818571
24913B

69⁹⁹
REG. \$99.99

SAVE
\$30

OEM TOOLS[®]



See Page 143 for More Savings on Creepers and Stands



DEDICATED TO HELPING YOUR BUSINESS RUN BETTER



The AutoZone® Tool and Equipment Team is here to ensure our customers are always satisfied. As our customer, you can expect fast, personalized and professional service. Our customer service associates have over 200 years of combined experience in the tool and equipment industry.

Call AutoZone® Tool & Equipment at 901-300-4878 for Questions Concerning:

- Equipment Selection
- Product Delivery
- Service After the Sale
- Product Availability
- Technical Support
- Ordering Capital Equipment

Call Your AutoZone® Commercial Sales Manager or Go to AutoZonePro.com

- To Place Orders for Parts, Tools and Equipment
- For Questions Related to Parts and Vehicle Accessories
- For Commercial Credit, Lease or Financing Information

Scan This QR Code to Link to the Digital AutoZone Tool & Equipment Catalog on AutoZonePro.com



Businesses can take advantage of IRS S-179 tax credits on equipment purchases. Contact your CPA for details.

FREE OVERNIGHT SHIPPING



Free overnight shipping available to continental U.S. for qualifying orders of 70 lb. or less. Free overnight shipping excludes: liftgate fees, residential delivery, non-network carriers, and certain freight intensive items that are shipped FOB.

IMPORTANT INFORMATION ABOUT RECEIVING YOUR FREIGHT ORDER

The freight company will call 24 hours prior to delivery. It is important to take or return their calls to schedule delivery. Most items are shipped freight prepaid. Limited access, residential, carrier surcharges, redelivery and storage fees are not included.

OFFLOADING? Do you need:



- Items shipped via flatbed and most lifts will require a forklift.
- Palletized items including most capital equipment and tool storage require a liftgate or forklift.
- Drivers will not allow you to break down pallets and offload by hand.
- Inside delivery is not available. Product will be dropped as close as safely possible. Make sure your location is accessible to the truck and driver.
- DO NOT SIGN until you have inspected the freight and confirmed carton/pallet count.

- Refuse shipment and/or notate any discrepancies or possible hidden damage on the bill of lading.
- DO NOT ACCEPT OR SIGN FOR DAMAGED ITEMS. Accepting and signing for a damaged or short shipment without notation releases the carrier and distributor from any claim or responsibility.
- Contact us at 901-300-4878 immediately with any questions or problems with delivery.
- For hidden minor or cosmetic damage, we may at our discretion, choose to send replacement parts.

ASK BEFORE YOU RETURN

Many of the Tool and Equipment products are covered by the manufacturer's warranty and will be serviced and repaired in the field.

Note: Most manufacturers require you to register your products with them before receiving support or service.

IF YOU HAVE QUESTIONS ABOUT WARRANTY OR RETURNS CALL 901-300-4878.

AUTOZONE® STORE MANAGERS AND COMMERCIAL SALES MANAGERS

Call Your Tool & Equipment Team at 901-300-4878 for Questions Regarding:

- Product Ordering and Availability
- Assisting Customers with Price Quotes
- Service After the Sale
- Help with Outside Buy/EPO Orders

Prices subject to change without notice. Prices do not include applicable taxes, vehicles, tires, rims, installation or optional equipment as shown. Please do not return purchases to the store. For information regarding warranty, repair, or any questions or concerns, call 901-300-4878.

To place orders or for pricing contact your AutoZone® Commercial Sales Manager.
 For product information, availability and product support, **call 901-300-4878.**

TOOLS AND EQUIPMENT IN THIS ISSUE:

Advanced Driver Systems (ADAS) . . . 25	Engine Service 49-53	Lighting & Flashlights 10-12	Shop Supplies 142-145
Air Compressors 70-71	Engine Stands & Cranes 84-85	Motorcycle Lifts 95	Smoke Leak Detectors 23, 120
Air Conditioning 59-69, 120	Evaporative Coolers 19-20	Oil Change 34-38, 122	Specialty Tools 42-48, 120, 122
Air Hoses & Reels 77	Exhaust Tubing Bender 126	Paint & Body 90, 130	Surface Prep 74, 76
Air Tools & Accessories 72-77	Fans 19-20	Parts Washers 97, 124-125, 144	Technician Sets 33, 80
Alignment 86-90	Fluid Handling 30-33	Power Tools & Accessories 78-80	Thread Repair 140-141
Automotive Lifts 90-97, 122	Generators 71, 127	Pressure Washers 127	Tire Service 90, 97-108, 121
Battery Service 13-16	Gloves 128, 147	Pullers 13, 43, 45, 48-51, 55-58, 65, 113, 120, 123, 130	Tool Organization 118-119
Brake Lathes 109	Grease Guns 29	Ratchets 7, 133-134	Tool Storage 5, 114-117
Brake Service 109-113	Hand Tools 5-8, 131-139	Regulators, Filters, Drains 77	Torque Wrenches 46, 105
Chassis & Suspension 55-58	Hardware Kits 47, 64, 69, 145	Rivet Tools 47	TPMS Tools 102-103
Cooling System 39-41, 120	Heating & Cooling 17-20	Safety Supplies 146-147	Tubing 76
Creepers & Seats 143-144	Heavy Duty 97, 120-122	Scan Tools 22, 120	Vacuum Pumps 61-62
Diagnostics 21-28, 120	Inflators 73	Shop Equipment 123-127	Welding & Cutting 128-129
Disconnect Tools 42	Jacks & Hydraulics 9, 81-85, 122	Shop Presses 123	Wheel Weights 106-107
Drill Bits & Extractor Sets 141	Jump Starters 9, 13-14		Wrenches 8, 131

BRANDS IN THIS ISSUE:

ABAC 70-71	Cool Boss 20	Lincoln 29, 32, 34, 38, 77, 124	Robinair 60
Access Tools 47	CPS 60, 62, 68, 120	Lisle 35, 38, 42, 44-45, 49-50, 52-53, 56, 108, 112, 130, 140-141, 146	Rotary 88, 92, 98, 121
AIRCAT 72-73	CRC 144	Livernois 53	SAS 146-147
AirSept 42, 69	Crushproof Tubing Co. 18	Mahle 33, 41, 59-60	Shark 35, 76, 78, 80, 96, 104, 110, 124
ALLDATA 21	CTA 37, 49	Manatec 101	Sheffield 117, 138
ALLSTART 14	Cutting Edge 85	Marson 47	Slip-N-Grip 142
American Forge & Foundry 83-85, 122	Duralast 5-9	Mastercool 20, 23, 39, 42, 60-69, 112, 120	Solar 14
Arrow Pneumatics 77	Ecotechnics 59-60	MaxJax 95	SRI 124
Associated 13-16	EnergyLogic 17	Mi-T-M 71, 126-127	Steck 44, 47, 84, 143
Astro 73, 103	FIX-A-THRED 140	Midtronics 13	Streamlight 12
ATD Tools 12, 130	FJC Inc. 64	Mityvac 28, 30-31, 111	SUNEX 75
ATEQ 102	Flexzilla 77	MotorVac 27, 33, 113	Sunfire 17
Atlas Automotive 94	Forney Industries 128-129	OEMTOOLS 10-14, 16, 19, 23-24, 29-46, 48-58, 61-65, 67-69, 72-85, 87, 95, 102-108, 110-113, 116-120, 122-126, 129-144, 146	SUR&R 27, 36, 145
Autel 16, 22, 24, 25, 103	Forward Lift 89, 92	ONE-Direct Sensors 102	Sure Shot 113
Balcrank 33, 35, 41	GearWrench 131	Phoenix Systems 111, 113	Sylvania 18
BelAire 71	GreatLite 11-12	Portacool 20	Symtech 126
BendPak 85-86, 89, 93-97, 122, 126	GreatNeck 12, 132, 137-139	Power Probe 26, 45	TEXA 25, 59, 120
BigVac 126	H&S Autoshot 128	Pro-Cut 109	Thexton 41
Branick 55, 103, 108	Hardware Machinery 47, 68, 145	OSP 55, 87	Titan 27
BRM 50, 113, 124	Hofmann 86-87, 89, 101	Quality Lifts 91	TMR/The Main Resource 104
Cal-Van42, 45, 51, 108, 130, 140-141	Homak 114-115, 117	QuickJack Lifts 95	TOPDON 13-16, 22, 26
CEMB 88, 99, 101, 121	Ingersoll Rand 72-74	Ranger 35, 83-84, 97, 99, 101, 109, 125	Traxion 143
Central Tools 46, 105, 110	Innova 28	Rapidair 76	Tuxedo 90
Challenger Lifts 85, 89, 91, 95-96, 122	IPC 125	Redline 23	UView 66-67
Champion Air Compressors 71	Jackson 129, 146		Viking 117
Champion Power Equipment 127	John Dow 32, 42, 84, 108, 142, 145		VIM Tools 111
Coats 88-89, 92, 98, 100, 104, 121	Ken-Tool 125		Water Works 125
	Knipex 27		Wiha Tools 27
	Lanair 17		Xtra Seal 108
	Lang 27, 112		

Prices subject to change without notice. Prices do not include applicable taxes, vehicles, tires, rims, installation or optional equipment as shown. Please do not return purchases to the store. For information regarding warranty, repair, or any questions or concerns, call 901-300-4878.

NEW ITEMS & DEALS

Offers Good While Supplies Last Through December 31, 2025

Oil Service

NEW

Universal No-Spill Oil Funnel Set
SKU 1533126 87025 **15⁰⁰**

- Includes 12 Adapters and 2 Extensions



STORE STOCKED

OEM TOOLS

Torque Limiting Adapter for Oil Filter Canister Caps
SKU 1580932 87118 **29⁹⁹**

NEW



See More OIL SERVICE on Pages 34-38

Fluid Handling

OEM TOOLS

1.5 Gallons (6.3 Qts.) Pneumatic/Manual Fluid Extractor
SKU 666978 24937 **109⁹⁹**
REG. \$154.99

SAVE \$45



See More FLUID HANDLING on Pages 30-33

Battery Charger

ASSOCIATED

6/12V, 40A Standard Duty Wheel Charger
SKU 344795 ASCUS20 **429⁹⁹**



BONUS VALUE: \$39.99

20 Ft. 4 Gauge Booster Cables with Storage Bag
24335

OEM TOOLS

With Purchase of: ASCUS20



See More BATTERY SERVICE on Pages 13-16

Jacks & Hydraulics

6 Ton Jack Stands (Pair)
SKU 1580891 24788 **99⁹⁹**

- Self-Locking Ratchet Allows Safe and Easy Adjustment

NEW



See More JACKS & HYDRAULICS on Pages 81-85

Tesla Jack Pads

Models 3/S/X/Y
SKU 1580896 28999 **29⁹⁹**

- Prevents Damage to the Battery Pack
- 4 Adapters and Storage Case

NEW

OEM TOOLS



Heating & Cooling

SUNFIRE

Portable Radiant Heater
160,000 BTU
SKU OSB SFRSF160 **3,499⁹⁹**

- Heats Up to 3,500 Sq. Ft.

NEW



See More HEATING & COOLING on Pages 17-20

Chassis & Suspension

OEM TOOLS

Master Inner Tie Rod Tool Set
SKU 344979 27178 **79⁹⁹**
REG. \$99.99

SAVE \$20



See More CHASSIS & SUSPENSION on Pages 54-58

Tire Service

GOATS

RC-55E and 1300 Series Tire Service Combo
SKU OSB AMMCOMB02 **14,849⁹⁹**

SAVE* \$449



* Savings based on the price of items if purchased separately.

See More TIRE SERVICE on Pages 97-108

Shop Equipment

OEM TOOLS

10 Ton Hydraulic Bench Top Shop Press
SKU 666327 25088 **499⁹⁹**
REG. \$599.99

SAVE \$100

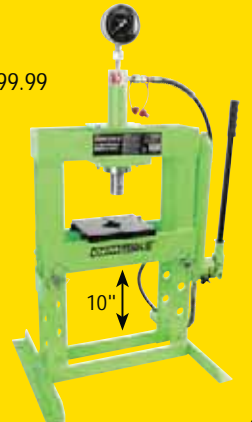

See More SHOP EQUIPMENT on Pages 123-127

Grease Gun

OEM TOOLS

Pneumatic with 18" Extension Hose
SKU 1207901 87205 **39⁹⁹**
REG. \$69.99

SAVE \$30



See More GREASE GUNS on Page 29

Prices subject to change without notice. Prices do not include applicable taxes, vehicles, tires, rims, installation or optional equipment as shown. Please do not return purchases to the store. For information regarding warranty, repair, or any questions or concerns, call 901-300-4878.

Duralast® TOOL STORAGE

Duralast 42" 4-Drawer Top Chest, Blue SKU 1354163

- 21-gauge steel construction
- 100 lb. soft-close full-extension drawers with liners
- Built-in power strip (4 outlets & 2 USB ports)
- 7,668 cubic inches of storage
- 400 lb. total weight capacity
- Combine with 1354168 (sold separately)



359⁹⁹

Duralast 30" 5-Drawer Mechanic's Cart BLUE SKU 1354167 BLACK SKU 1354164

- High-capacity, full-extension ball bearing drawer slides
- 90-degree lid opening with dual gas struts
- 15,000 cubic inches of storage
- 700 lb. total weight capacity



329⁹⁹

42" 9-Drawer Tool Cabinet, Blue SKU 1354168

- 21-gauge steel construction
- 100 lb. soft-close full-extension drawers with liners
- 5"x2" heavy-duty casters to support up to 1,200 lbs.
- 10,532 cubic inches of storage
- 800 lb. total weight capacity
- Combine with 1354163 (sold separately)

449⁹⁹

Duralast 30" 4-Drawer Technician Cart BLUE SKU 1354165 BLACK SKU 1354166

- High-capacity, full-extension ball bearing drawer slides
- 90-degree lid opening with dual gas struts
- 12,600 cubic inches of storage
- 580 lb. total weight capacity



249⁹⁹

SPECIAL DEALS

Duralast 1/4", 3/8", 1/2" Drive 435PC Mechanic's Tool Set SKU 1089589 Storage NOT Included

429⁹⁹



\$1,850 Value

- Features 237 Chrome Sockets, 51 Wrenches, 42 Impact Sockets, 6 ratchets & more!
- The most tools for your money, all guaranteed for life

Duralast 1/4", 3/8", 1/2" Drive 335PC Mechanic's Tool Set SKU 1092684 Storage NOT Included

269⁹⁹

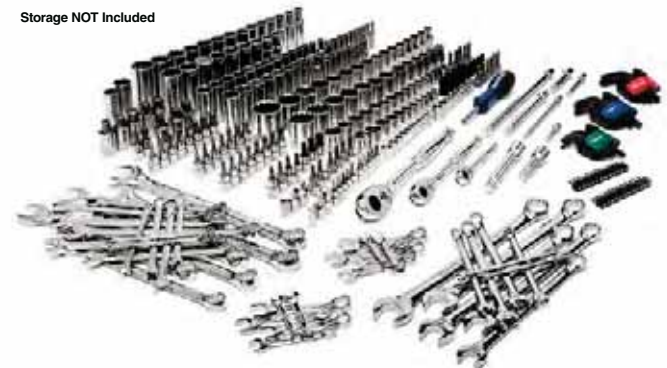

\$1,350 Value

- Features 210 Chrome Sockets, 41 Wrenches, 3 Ratchets & more!
- Professional Grade Tool Selection, All Guaranteed for Life

Duralast® MECHANIC'S TOOL SETS

Duralast

265PC Mechanic's Tool Set

SKU 1077624

179⁹⁹



- 1/4-in, 3/8-in, and 1/2-in drive mechanic's tool set
- 6-point standard and deep sockets (1/4-in, 3/8-in drive) and 12-point standard sockets (1/2-in drive)
- Sockets feature off-corner loading design to help prevent the rounding of fasteners
- Alloy Steel sockets and drive tools heat treated for superior strength



72-Tooth Ratchet
5° swing arc for tighter turns



Chamfered Lead-In
for easier fastener placement



Off-Corner Loading
reduces fastener rounding

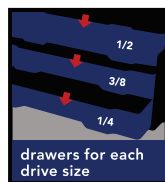

drawers for each drive size

Duralast

60PC Mechanic's Tool Set

SKU 15881

59⁹⁹



- 3/8-in drive mechanic's tool set
- 6-point standard and deep sockets
- Sockets feature off-corner loading design to help prevent the rounding of fasteners
- Alloy Steel sockets and drive tools heat treated for superior strength

Duralast

180PC Mechanic's Tool Set

SKU 52378

119⁹⁹



- 1/4-in, 3/8-in, and 1/2-in drive mechanic's tool set
- 6-point standard and deep sockets (1/4-in, 3/8-in drive) and 12-point standard sockets (1/2-in drive)
- Sockets feature off-corner loading design to help prevent the rounding of fasteners
- Alloy Steel sockets and drive tools heat treated for superior strength

Duralast

90PC Mechanic's Tool Set

SKU 52377

89⁹⁹



- 1/4-in and 3/8-in drive mechanic's tool set
- 6-point standard and deep sockets
- Sockets feature off-corner loading design to help prevent the rounding of fasteners
- Alloy Steel sockets and drive tools heat treated for superior strength

Duralast

45PC Mechanic's Tool Set

SKU 15879

39⁹⁹



- 1/4-in drive mechanic's tool set
- 6-point standard and deep sockets
- Sockets feature off-corner loading design to help prevent the rounding of fasteners
- Alloy Steel sockets and drive tools heat treated for superior strength
- Premium S2 steel bits for durability

Duralast® TOOL BUNDLE DEALS

139⁹⁹

ROADSIDE BUNDLE DEAL

Keep this Duralast Tools roadside bundle with you on the go, and be ready for any obstacle that comes your way!



180 PC 1/4", 3/8", 1/2" Drive Tool Set SKU 52378

- Comprehensive selection of 1/4", 3/8", and 1/2" drive tools
- Forged from alloy steel for durability and long-lasting performance
- Slim profile blow mold case, allows for convenient storage on the go



1/2" Drive Extendable Breaker Bar SKU 582082

- Collapses down to 10 inches and extends all the way to 15 inches to provide greater access and leverage
- Chamfered square drive lead-in helps provide easy placement of sockets onto drive

49⁹⁹

IMPACT SOCKET BUNDLE DEAL

Conveniently stored in a blow mold storage case, don't miss on this opportunity to score a hot deal on Duralast Impact Sockets! Made with forged Chrome Molybdenum, these sockets are built for strength and durability in impact use.



10 PC 1/2" Drive Deep Metric Impact Sockets SKU 914180

- Contains: (10) 1/2" Drive Deep Metric Impact Sockets: 10, 11, 12, 13, 14, 15, 16, 17, 18, 19mm

9 PC 1/2" Drive Deep SAE Impact Sockets SKU 569664

- Contains: (9) 1/2" Drive Deep SAE Impact Sockets: 1/2, 9/16, 5/8, 11/16, 3/4, 13/16, 7/8, 15/16, 1

49⁹⁹

FLEX HEAD RATCHET BUNDLE DEAL

These Duralast 100 Position Flex Head ratchets are designed with a patented stacked pawl technology - allowing for a reduced ratcheting arc of just 3.6 degrees. These ratchets feature a flex head design with 6 different locking positions, and are fully guaranteed for life.



3/8" Drive Flex Fine-Tooth Ratchet (100T) SKU 565718

1/4" Drive Flex Fine-Tooth Ratchet (100T) SKU 565715

Duralast® RATCHETING WRENCH SETS



Work Faster and Smarter with Duralast Ratcheting Wrenches

- 72T Ratcheting box ends need as little as 5 degrees of sweep to move a fastener
- The small ratcheting box end head allows for access to tight areas where a ratchet won't fit
- Manufactured from alloy steel for superior strength and longer life span
- Available in 12-pt. ratcheting, 12-pt. flex-head ratcheting, 12-pt. reversible ratcheting, 12-pt. combination ratcheting, and universal profile ratcheting

Duralast

6PC Flex-Head Ratcheting Wrench Sets

MM SKU 569808
SAE SKU 569818

59⁹⁹
each



- 12-point flex head ratcheting combination wrenches
- Ratcheting flex heads allow for accessing fasteners at an angle for improved access
- Featuring off-corner loading design to help prevent the rounding of fasteners

Duralast

6PC Universal Ratcheting Wrench Sets

MM SKU 570925
SAE SKU 570926

34⁹⁹
each



- Universal profile ratcheting box-ends allow engagement on 6 fastener types (6-point, 12-point, partially rounded, spline, square, and External TORX®)
- Alloy Steel wrenches heat treated for superior strength
- Chamfered lead-ins for easy placement onto fasteners

Duralast

6PC Reversible Ratcheting Wrench Sets

MM SKU 570923
SAE SKU 569807

59⁹⁹
each



- 12-point reversible ratcheting combination wrenches
- Featuring off-corner loading design to help prevent the rounding of fasteners
- Alloy Steel ratcheting wrenches heat treated for superior strength

Duralast

6PC Ratcheting Wrench Sets

MM SKU 569779
SAE SKU 570921

34⁹⁹
each



- 12-point ratcheting combination wrenches
- Featuring off-corner loading design to help prevent the rounding of fasteners
- Alloy Steel ratcheting wrenches heat treated for superior strength

Duralast

2PC Quadbox Ratcheting Wrench Sets

MM SKU 951644
SAE SKU 951643

34⁹⁹
each



- 12-point metric reversible ratcheting 4-in-1 wrenches
- Each wrench features 4 sizes for convenience
- Alloy Steel ratcheting wrenches heat treated for superior strength
- Reversing levers allow quick directional changes

Duralast® LIFT EQUIPMENT & BATTERY CHARGERS

Duralast GOLD 3 Ton Aluminum Floor Jack SKU 1276166



- Light weight design for easy mobility
- 3 ton capacity dual pump piston with universal release
- Slow descent release

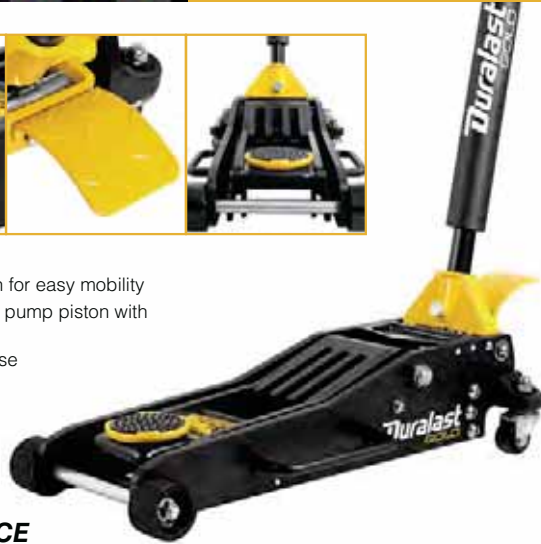

FEATURE PRICE
249⁹⁹

Duralast GOLD 3-1/2 Ton Professional Foldable Garage Jack SKU 1276164



- 30" lift height with adapter
- Dual piston lift pump
- Slow descent release for controlled load lowering



FEATURE PRICE
229⁹⁹

Duralast 2.5 Ton Jack & Stands Kit SKU 562996

114⁹⁹

- 2.5 ton capacity
- 2.5 ton stands



Duralast 2.5 Ton SUV Jack SKU 189970

104⁹⁹

- Lift range: 5.88" - 20.88"
- 1-year warranty
- Rotatable saddle for easier positioning
- Extra heavy gauge steel chassis frame and side plates for added strength



Duralast 3 Ton Garage Jack SKU 1399157

149⁹⁹

- Lift range: 5.1" - 18.6"
- 1-year warranty
- Rotatable saddle for easier positioning
- Heavy duty steel construction - high grade steel with powder-coated finish



Duralast 6 Ton Jack Stands SKU 234799

67⁸⁹

- Full welded heavy gauge steel base
- Large Cast iron ratchet pawls for secure locking
- Multiple height positions



Duralast 250 Amp 12 Volt Battery Charger SKU 1277303

149⁹⁹

- The DL-250D is compatible with 12-volt standard, lithium, AGM, gel, and deep-cycle batteries
- The 250-amp engine start is strong enough to jump start cars, SUVs, trucks, and boats
- Manual operation controlled by 135-minute timer and manual rate selection knob
- Built-in ammeter lets you monitor the complete charging process



Duralast Lithium Battery Booster/Jump Pack SKU 567656

99⁹⁹

- Powerful 1200-amp jump start is strong enough for cars, trucks, motorcycles, boats, SUVs, and other large engines
- 150-PSI air compressor features a digital pressure gauge making it easy to inflate tires, toys, mattresses, and more
- The 2.4-amp USB port charges smartphones and other mobile devices two times faster than a standard USB charger"



HIGH-POWERED, RECHARGEABLE WORK LIGHTS



Portable Dual Mode LED Work Lights with Multi-Position Mounting

- Dual Mode Features a Flood LED Work Light and a Directional Flashlight
- 180° Magnetic Adjustable Base
- USB-C Rechargeable



WATER RESISTANT IPX-6



180° Multiple Positions for Angling Light



200 Max. Lumens
SKU 1525563
32132 **34⁹⁹**

- Heavy-Duty Belt Clip
- Charging Time: 2.5 Hours

Heavy Duty Clip



Magnetic Base

LUMENS

50 LUMENS WORK LIGHT
50 LUMENS LED LOW
200 LUMENS LED HIGH

RUNTIMES

4hrs WORK LIGHT
8hrs LED LOW
2hrs LED HIGH

400 Max. Lumens
SKU 1525555
32124 **44⁹⁹**

- 360° Rotating Hanging Hook
- Charging Time: 2.5 Hours

360° Hang Hook



Magnetic Base

LUMENS

200 LUMENS WORK LIGHT
120 LUMENS LED LOW
400 LUMENS LED HIGH

RUNTIMES

5hrs WORK LIGHT
9hrs LED LOW
3hrs LED HIGH

600 Max. Lumens
SKU 1525559
32126 **49⁹⁹**

- 360° Rotating Hanging Hook
- Charging Time: 3.5 Hours

360° Hang Hook



Magnetic Base

LUMENS

200 LUMENS WORK LIGHT
200 LUMENS LED LOW
600 LUMENS LED HIGH

RUNTIMES

9hrs WORK LIGHT
12hrs LED LOW
3hrs LED HIGH

Flashlights

2 Pack Button LED Lights
SKU 1525557
32129 **34⁹⁹**

- Magnetic Base for Hands-Free Use
- Charging Time: 0.5 Hours
- Includes: Two LED Lights with Two Charging Ports, USB-C and Micro USB, and 1 Charging Cable



Magnetic Base

LUMENS

10 LUMENS LED LOW
100 LUMENS LED HIGH
3hrs LED LOW
20mins LED HIGH

RUNTIMES

LED Light with Auto Sensor
SKU 1525569
32122 **39⁹⁹**



- Auto Sensor Automatically Turns Light Off When Sensor is Covered
- Dual Mounting Options; Heavy-Duty Clip and Dual Magnets
- Charging Time: 3.5 Hours

LUMENS

100 LUMENS WORK LIGHT
80 LUMENS LED LOW
600 LUMENS LED MEDIUM
1200 LUMENS LED HIGH

RUNTIMES

12hrs WORK LIGHT
10hrs LED LOW
5.5hrs LED MEDIUM
1.5hrs LED HIGH

Mini Rechargeable LED Light
SKU 1525564
32137 **19⁹⁹**

- Dual Mounting Options; Heavy-Duty Clip and Dual Magnets
- Charging Time: 2.5 Hours



Heavy-Duty Clip

Magnetic Base

LUMENS

100 LUMENS LED LOW
300 LUMENS LED HIGH
3hrs LED LOW
1.5hrs LED HIGH

RUNTIMES

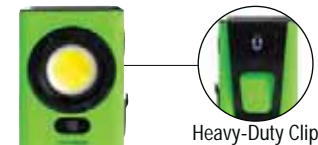

Heavy-Duty Clip

Magnetic Base



LIGHTWEIGHT
5.2 oz.



AUTO SENSOR
AUTO ON/OFF SENSOR

Work Lights



3-in-1 Multi-Use Rechargeable Diagnostic Under-the-Hood Work Light

SKU 591153 24609 **144⁹⁹**

- 3 Different Light Modes - White, Yellow (Smoke Detection), UV/Black (Leak Dye Detection)
- 400 Lumens of Super Bright Light Lasts More Than 5 Hours (White Light)
- Holds Charge for a Longer Run Time with 4400 mAh Li-ion Battery
- Built-In Power Bank/Source Charges Cell Phones, Tablets and Handheld Devices
- Includes Universal Micro USB Charger
- LCD Battery Indicator Screen Displays Charge Level
- Strong Magnets on Each End
- Run Time: White (5.5 Hrs.), Yellow (5.5 Hrs.), UV/Black (12.5 Hrs.)
- Accessory Kits Available

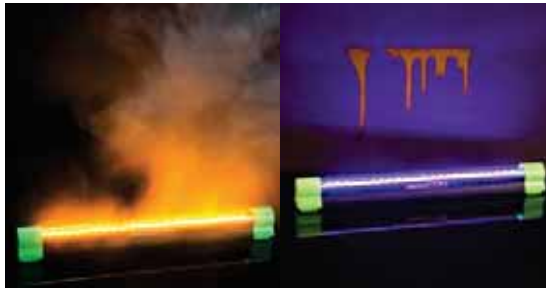

UV Leak Dye Detection Light



400 Lumens Super Bright Work Light



Yellow Smoke Detection Light

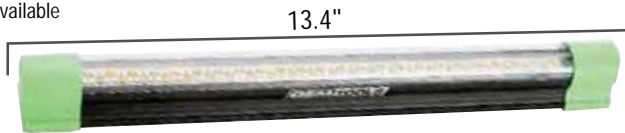

Multi-Application Work Lights Deliver Functionality of Several Lights in Just One Versatile Light

5 Light Modes: High, Medium, Low, Strobe, SOS

600 Max. Lumens
SKU 822266 25997 **84⁹⁹**

- 6 Hr. Runtime on High



1000 Max. Lumens
SKU 850228 24604 **174⁹⁹**

- 9 Hr. Runtime on High



360 Max. Lumens
SKU 603726 24695 **34⁹⁹**

- 3.5 Hr. Runtime on High
- 4000 mAh Li-ion Battery

4 Light Modes: High, Medium, Low, SOS

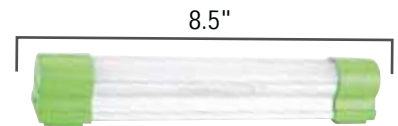

STORE STOCKED

Mechanics 500 Max. Lumen Rechargeable Flashlight and 450 Lumen Ultra Slim Wand with UV Inspection

SKU 344835 24607 **99⁹⁹**

- 5 Light Modes: 100%, 50%, 25%, Strobe and SOS
- Flashlight Head Can Be Removed and Replaced with the Slim Inspection Light (as Shown)
- 3 Powerful, UV LED Lights on Inspection Light Detect Leaks Quickly and Easily



Magnetic Rechargeable LED Work Light

SKU 819644 25982 **49⁹⁹** REG. \$79.99

- 3W COB LED, Super Bright White Lights: 400 Lumens
- 3.7V 2200 mAh Li-ion Battery
- Runtime: 3 Hrs. (Work Light), 9 Hrs. (Torch Light)
- Powerful Magnets on the Back and Swivel Base
- Includes: USB Cable for Recharging

Swivels, Hangs or Sticks



Offer Good Through December 31, 2025

Pivoting Ultra-Slim 300 Max. Lumen Work Light

SKU 603727 24696 **27⁹⁹**

- Ultra-Slim Body Design Pivots 180° Providing More Light to Any Work Area
- Magnetic Base Attaches to Any Ferrous Surface
- 4 Light Modes: High, Low, Top Light and Handle Spotlight
- Top Light Illuminates the Tightest Work Areas

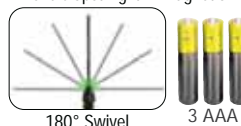
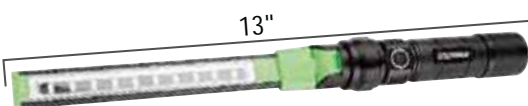

Rechargeable Multi-Head All-in-One Work Light Kit

SKU 765525 24648 **124⁹⁹**

- Quick-Attachment Coupler Allows for Easy Change Between 3 Interchangeable Heads

Comes with USB Charging Cord, AC Adapter, 180° Swivel Hook and (1) 18650 Rechargeable Battery



Work Lamp Attachment for 24648 Work Light Set

SKU 884377 24648E **19⁹⁹**



STORE STOCKED

LIGHTING

Flashlights

Periscope LED Flashlight
SKU 526504 25458 **14⁹⁹**

- Chip On-Board LED
- Beam Distance: 2 Meters
- Includes: Magnetic Base to Stand Upright and 2 AA Batteries



OEM TOOLS



2 AA
60 LUMENS



6.0 hrs MAX RUNTIME

Tire Knocker with Flashlight

SKU OSB 74217 **29⁹⁹**

- Water Resistant
- 130 Meter Beam Distance
- Diameter: 1.25"



GreatNeck



3 AA
MAX OUTPUT 150 LUMENS

30 hrs MAX RUNTIME

For OSB, Call 901-300-4878

E36 Cree Rechargeable Flashlight Kit

SKU 568461 EXPE36-E02 **59⁹⁹**

- Beam Distance: 300 Meters
- Impact Resistant Up to 1.5 Meters
- IPX-6 Water Resistant
- Includes: (1) 18650 Battery and Charger



GreatLite



1000 LUMENS

2.0 hrs RUN TIME

Stinger LED with AC/DC

SKU 291368 STL75732 **249⁹⁹**

- 425 Lumens
- Runtime: 10 Hours
- Beam Distance: 322 Meters
- Four Lighting Modes: High, Medium, Low and Strobe



STREAMLIGHT

Pen Lights

Stylus Pro with White LED

- 48 Lumens
- Runtime: 7.5 Hours
- Waterproof Construction with an Unbreakable Polycarbonate Lens Pocket Clip

Blue
SKU 291362 STL66122 **44⁹⁹ each**

Black
SKU 291408 STL66118

Red
SKU 291358 STL66120

Silver
SKU 291359 STL66121



STREAMLIGHT

Cree LED Pen Light

- 3 Modes: Low (50 Lumens), High (150 Lumens) and Strobe
- 80 Meter Beam Distance
- Anodized Aluminum Body is Impact and Water Resistant
- Battery Runtime: 6 Hours (Low), 3 Hours (High)
- Comes with 2 AAA Batteries and Tactical Clip

Red
SKU 592188 32838 **24⁹⁹ each**

Black
SKU 592184 32835

Silver
SKU 592183 32839

Blue
SKU 592185 32836

Green
SKU 592186 32837



GreatLite

150 LUMENS

6.0 hrs MAX RUNTIME

2 AAA

Underhood Lights

2,000 Lumen LED Corded/Cordless

SKU 1414959 ATD80357 **219⁹⁹**

- 40" Light Bar Provides 2000 Lumens of Bright Light
- Hooks Extend 55" to 83" to Fit New SUVs and Light Trucks
- 25' Removable Cord Remains Flexible in Cold Weather
- 2 Modes: High-2000 Lumens/Low-1000 Lumens
- 5200 mAh Li-ion Battery Provides Up to 2 Hours (High), Up to 4 Hours (Low) Runtime



ATD
AMERICAN TRUCK DISTRIBUTORS

Inspection Lights

700 Max. Lumen Rechargeable COB LED Slim Inspection Light

SKU 418752 24646 **19⁹⁹**

- Unique Variable Dial Lets You Control Output (0 to 700 Lumens)
- Runtime: 10 Hours (at 50% Power), 2.5 Hours (at 100% Power)
- Removable Magnetic Base with 360° Swivel and Lock Feature Lets You Adjust Angle to Point Light Where it's Needed



MAX OUTPUT 700 LUMENS



10 hrs MAX RUNTIME

2-in-1 Rechargeable Pocket Light

SKU 081751 26029 **24⁹⁹**

- Super Bright COB LED Work Light with Integrated LED Flashlight
- Easy Hands-Free Operation with Magnetic Base and Magnetic Pocket Clip
- Max. Output (Work Light): 200 Lumens
- Max. Output (Flashlight): 140 Lumens
- Includes: (1) 18650 Li-ion Rechargeable Battery and (1) USB Charging Cord



MAX OUTPUT 200 LUMENS

3.0 hrs MAX RUNTIME



120° Rotating Magnetic Clip

OEM TOOLS

BATTERY SERVICE

TO ORDER, contact your Commercial Sales Manager or go to AutoZonePro.com

BATTERY SERVICE

Battery Testers

OEM TOOLS®

Professional Series Battery Tester
SKU **750009** **14.99**
24508

- Large Tester Uses Gravity with the Number of Floating Discs to Show State of Battery Charge
- Specific Gravity Levels are Printed on the Tough, See-Through Plastic Body
- Large 16-1/4" Disc-Type Tester is Accurate Down to -40°F



OEM TOOLS®

Digital Battery Analyzer
SKU **819073** **39.99**
24359

- Shows Available Power in CCA Starter and Charging System Testing
- Easy-to-Read Backlit LCD Screen
- Voltage Range: 1.5-15VDC
- Battery CCA: 200-1200



OEM TOOLS®

100 Amp Battery Load Tester
SKU **203583** **39.99**
24338

- Conveniently Tests Batteries in Just 10 Seconds
- Battery Load Test: 100A (12V), 50A (6V)
- Designed to Work on Both 6V and 12V Batteries Up to 1,000 CCA
- Determines State of Charge, Cranking and Charging Volts
- Convenient Handle for Transport



OEM TOOLS®

500 Amp Carbon Pile Load Tester
SKU **1168827** **124.99**
24336

- Variable Load Capability to 500 Amps
- Tests Batteries to 1,000 CCA
- Test Alternators, Regulators and Starters
- Large, Easy-to-Read Gauges
- Heavy Duty Clamps



STORE STOCKED

MIDTRONICS Advancing Battery Management

Battery Conductance Tester
SKU **291330** **249.99**
MIDPBT100

- Tests Both the Starter and the Charging System
- Tests 12V Automotive Batteries from 200 to 850 CCAs
- Durable Design for the Workshop or in the Field



TOPDON®

BT MobilePro S Jump Start/Power Bank/BSC System Analyzer
SKU **1485041** **124.99**
TPDBTMPROS

- Turns Your Diagnostic Scan Tool into a Battery Tester
- Compatible to Phoenix Line of Diagnostic Scanners
- Battery, Cranking and Charging Tests
- Tablet Compatibility
- Test Voltage: 12V
- Test Range: 100~2000CCA
- Battery Type: Regular Flooded, AGM, EFB and GEL
- Test Standards: CCA, BCI, CA, MCA, JIS, DIN and More



TOPDON®

BT600 Battery Tester with Printer
SKU **1339732** **139.99**
TPDBT600

- 3.5" Color Screen
- Built-In Thermal Printer
- Performs Complete Battery, Cranking and Charging Tests
- Large, Reinforced, Smoke-Free and Spark-Free Copper Clamps
- Quick and Accurate Test Results



ASSOCIATED

12V Digital Battery Electrical System Tester with Printer
SKU **343373** **469.99**
ASC12-1015

- Tests Both Batteries Up to 1,700 CCA and Alternators
- Tests Starters and Charging Systems
- Backlit Digital Display
- 9 Languages
- Includes: Deluxe Case and Extra Print Paper



Replacement Clamps
SKU **1544657** **29.99**
TPDBT600RC

Thermal Printer Paper for BT600, BT300P
SKU **1442591** **34.99**
TPDBTPAPER

12/24V Digital Battery Electrical System Tester with Printer
SKU **1491305** **529.99**
ASC12-2415

- Tests Both Batteries Up to 2,000 CCA and Alternators

Battery Service Tools

Side Terminal Battery Wrench

- For Use with Side Terminal Batteries Found on Many GM and Other Domestic Vehicles

5/16" SKU **466513** **9.99** **25287** Length: 5-1/2"

10 mm and 5/16" SKU **965838** **19.99** **25282** Length: 12" Double Sided

For Use on 5/16" and 10 mm Battery Terminals



2 Liter Battery Filler
SKU **972771** **14.99**
87010

- Automatic Shut-Off to Prevent Overfilling
- Fills Battery to Proper Level without Spilling



OEM TOOLS®

Battery Terminal Puller
SKU **466489** **14.99**
25121

- Use to Remove Battery Terminal Clamp without Damaging the Battery Post
- Puller Will Also Work on Corroded Spring-Type Clamps



Battery Nut Pliers
SKU **943134** **14.99**
25123

- Easily Tighten and Loosen Nuts
- Offset Handles
- Serrated Jaws for a Firm Grip



Battery Carrier
SKU **002284** **14.99**
25316

- Designed to Grab, Lift and Carry Top Post and Side Terminal Batteries
- Grips Battery Widths from 5" to 7" with Rubber Pads
- Plastic Hand Grip Provides a Firm Hold



6 Piece Battery Service Kit
SKU **1168822** **69.99**
25110

- Includes: Battery Terminal Puller, 4-Way Post Cleaner, Battery Nut Pliers, Extended 5/16" and 10 mm Battery Terminal Wrench, 5/16" Side Terminal Battery Wrench and a Side Terminal Brush Organized in a Heavy Duty, Roll-Up Storage Sleeve



Prices subject to change without notice. Prices do not include applicable taxes, vehicles, tires, rims, installation or optional equipment as shown. Please do not return purchases to the store. For information regarding warranty, repair, or any questions or concerns, call 901-300-4878.

BATTERY SERVICE

Jump Starters

Battery Tester and Jump Start
SKU **1368635** **119⁹⁹**
TPDV2200PLUS

- Jump Start Capacity: 8L Gas, 6L Diesel
- 2200A Peak Current for Jumps
- Use the App to Perform Detailed Battery Tests
- 300 Lumen LED Light with Solid, SOS and Strobe Functions
- Output Ports: Type-C: USB1, USB2, DC



TOPDON®

JumpSurge 3000 Amp Portable Jump Starter
SKU **OSB TPDJS3000** **169⁹⁹**

- Sturdy Outer Housing Resistant to Water, Dust and Wear**
- 45 Jumps on a Single Charge
 - USB Quick Charge 3.0 Port
 - Heavy Duty Smart Clamps



TOPDON®

Kwikstart® 12 Volt Portable Power and Jump Start
SKU **850637** **264⁹⁹**
ASC6256

- Peak Amp Output: 1700 Amps
- 360 CCA of Boost Assist
- (2) 12V DC Accessory Outlets to Power and/or Recharge DC Electronics
- 32" Heavy Duty Cables and USB Port



ASSOCIATED

30,000 mAh Lithium Jump Starter for V10 and Diesel
SKU **1268417** **249⁹⁹**
CAL590

- Improved Design**
- Vehicle Jump Starter and Backup Charger for Portable Electronics
 - 800 Cranking Amps and 1800 Peak Amps
 - 30,000 mAh High Capacity Li-ion Battery
 - Fast Charging with Low Self-Discharge Cycle
 - Includes: Intelli-Clamps for Jumpstarting with Built-In Safety and Diagnostic Features



ALLSTART

Premium 1700 Peak Amp 12 Volt Jump Starter
SKU **OSB SOLJNC770R** **324⁹⁹**

- Heavy Duty Clamps with 68" Cables
- 1700 Peak Amps: 425 Cranking Amps
- Dual USB Outlets to Charge Mobile Devices
- Master ON/OFF Switch



SOLAR

1700 Peak Amp 12 Volt Jump Starter
SKU **OSB SOLJNC660** **299⁹⁹**

- Heavy Duty Clamps with 46" #2 AWG Welding Cables.
- 1700 Peak Amps: 425 Cranking Amps
- Heavy Duty Clamps with 46" Cables

3400 Amp 12/24 Volt Jump Starter
SKU **OSB SOLJNC1224** **649⁹⁹**

- Voltmeter Provides Charge Status of Onboard Battery
- Clore PROFORMER Battery Technology
- 3400 Peak Amps and 850 Cranking Amps - 12V
- 1700 Peak Amps and 425 Cranking Amps - 24V



SOLAR

2-in-1 2200 Peak Amp Jump Starter and Tire Inflator
SKU **1485043** **129⁹⁹**
TPDV2200AIR

- Battery Capacity: 12000mah
- Delivers a Powerful 2200A Peak Current with Up to 25 Starts Per Charge
- Capable of Jump-Starting Vehicles with Engines Up to 8.0 Liters for Gasoline or 6.0 Liters for Diesel
- Functions as a PD45W Fast-Charging Power Bank
- 400-Lumen LED Flashlight
- Tire Inflator Fills in Under 3 Minutes



TOPDON®

2-in-1 4500 Peak Amp Jump Starter and Battery/System Tester
SKU **1485040** **229⁹⁹**
TPDV4500PLUS

- Up to 45 Jump Starts on a Single Charge
- Test and Monitor Battery with App
- Peak Amps: 4500
- 500 Lumen Flashlight
- Outputs: Bidirectional TYPE-C, USB1, USB2
- IP65-Rated Casing
- Includes: D45W Charger Adapter, DC Adapter, DC Adapter and PD100W Cable



TOPDON®

To Confirm Price, Availability and Ordering Instructions on OSB, Call 901-300-4878

Wheeled Chargers

Battery Charger 12V
SKU **OSB SOL4735** **289⁹⁹**

- EZ View Control Panel
- 200 Amp Engine Starting Assistance
- 40 Amp Fast Charge Rate
- 5 Amp Setting for ATVs, Boats, Lawn and Garden Applications



SOL4735

Battery Charger with Engine Start 12/24V
SKU **OSB SOL4745** **369⁹⁹**

- 40 Amp 12V, 20 Amp 24V Charge Rate

SOLAR

ASSOCIATED

6/12V, 40A Standard Duty Wheel Charger
SKU **344795** **429⁹⁹**
ASCUS20

- 40 Amp Charger with 90 Minute Timer
- 40 Amp Continuous Rating at 6/12 Volts
- 200 Amp Cranking Assist and 330 Amps Boost
- Fan Cooling Prevents Overheating
- UL Listed
- Two Year Manufacturer's Warranty



Safe In Any Weather



Made in USA

BONUS
VALUE: \$39.99

OEM TOOLS®

20 Ft. 4 Gauge Booster Cables with Storage Bag
24335



With Purchase of:
ASCUS20

BATTERY SERVICE

TO ORDER, contact your Commercial Sales Manager or go to AutoZonePro.com

BATTERY SERVICE

Associated Battery Chargers

ASSOCIATED



Safe In Any Weather



Made in USA



ASC6002B

ASC6021AGM

ASC6012AGM

ASCESS6008MSK

ASCESS6007B

ASCIBC6008MSK

	Commercial Duty Charger	Heavy Duty Fleet Charger/Analyzer	Heavy Duty Charger	Intellamatic® Charger and Re-flash Power Supply			
	SKU 221248 ASC6002B	SKU 1414394 ASC6021AGM	SKU 662763 ASC6012AGM	SKU 344790 ASCESS6008 (Not Pictured)	SKU 343379 ASCESS6008MSK	SKU 343370 ASCESS6007B	SKU 662745 ASCIBC6008MSK
Charger Type	Wheel	Wheel	Wheel	Wheel	Wheel	Wheel	Wheel
UL of CSA Continuous Amperage Charging Rate	100/80A	70/65/30A	70/60A	60A	60A	40A	60A
Re-Flash Power Supply Output Amperage	N/A	N/A	N/A	70A @ 13.9V	70A @ 13.9V	45A @ 13.9V	70A @ 13.9V
Crank Assist Amperage	400	205A	250	270	270	130	270
Operating Charging Voltage	6/12/18/24V	6/12/24V	6/12V	12V	12V	12V	12V
Battery Types	SLA	SLA, AGM, EFB	SLA, AGM, EFB	SLA, AGM, Gel-Cell, EFB	SLA, AGM, Gel-Cell, EFB	SLA, AGM, Gel-Cell, EFB	SLA, AGM, EFB, Li-ion, Gel-Cell
Smart Charger	N	N	N	Y	Y	Y	Y
Adjustable Charging Voltage	N	N	N	N	N	N	Y
Adjustable Re-Flash Power Supply Voltage	N	N	N	Y	Y	Y	Y
Memory Saver Mode	N	N	N	N	Y	N	Y
DC Cable Length and Gauge	8' 4AWG	6.5' 4AWG	6.5' 6AWG	6.5' 6AWG	6.5' 6AWG	6.5' 6AWG	6.5' 6AWG
Warranty*	2 Year B2B 5 Year Limited	2 Year B2B 5 Year Limited	2 Year B2B 5 Year Limited	2 Year B2B 3 Year Limited	2 Year B2B 3 Year Limited	2 Year B2B 3 Year Limited	2 Year B2B 3 Year Limited
<i>Price</i>	1,224⁹⁹	874⁹⁹	679⁹⁹	979⁹⁹	1,114⁹⁹	784⁹⁹	1,379⁹⁹

*Two years bumper to bumper (B2B) manufacturer's warranty with five years transformer/rectifier for heavy duty battery chargers (6001A, 6002B, 6006, 6009 and 6012) and three years transformer/rectifier warranty for INTELLAMATIC wheeled smart chargers.

Power Supply

ASSOCIATED

12V - 90A Re-flash Power Supply and Charger
SKU **OSB ASCESS6100** **1,599⁹⁹**

- Adjustable Power Supply from 12.6V to 14.9V at Up to 90 Amps
- Safe for All Batteries Including AGM, EFB, Li-ion and Gel
- OEM Vehicle Manufacture Approved
- 8.4 Ft. DC Leads

For OSB, Call 901-300-4878



120A Power Supply and Battery Charger

SKU **1485033 TPDT1200005** **899⁹⁹**

- Intelligent Current (5-120A) and Voltage (11-16.8V) Output Adjustment
- 3 Major Charging Modes and 9-Step Smart Charging
- Compatible with Lead-Acid Batteries and Lithium Batteries
- Clamp Cable Length: 16 Ft.



TOPDON®

Prices subject to change without notice. Prices do not include applicable taxes, vehicles, tires, rims, installation or optional equipment as shown. Please do not return purchases to the store. For information regarding warranty, repair, or any questions or concerns, call 901-300-4878.

AZG0425

BATTERY SERVICE

Booster Cables

OEM TOOLS

20 Ft. 4 Gauge Booster Cables with Storage Bag
SKU 1168815 24335 **39⁹⁹** REG. \$59.99

SAVE \$20

20 Ft. Extra Flexible Cables

- Extra Long 20 Foot Flexible Cables Expands Your Reach
- Tangle Free Design Ensures Quick and Easy Connections
- Insulated Clamps Fit Top and Side Post Batteries
- Oil, Gas and Acid Resistant All Copper Wire
- Includes: Storage Bag



Offer Good Through December 31, 2025

Smart Charger

TOPDON

30A Smart Charger and Power Supply
SKU 1442582 TPDT30000 **299⁹⁹**

- Suitable for Multiple Battery Types, Including AGM, LI, WET, GEL, MF CAL and EFB
- 9-Step Smart Charging, Checks for Sulphation and Acid Stratification, Repairs Batteries, Prevents Battery Damage
- Works as a Stable Power Supply for 12V and 24V Devices
- Current Range: 12V-30A, 24V-15A, 6V-15A, 12V-10A
- Clamp Cable Length and Gauge: 7.2', AWG10



One Charger Does It All

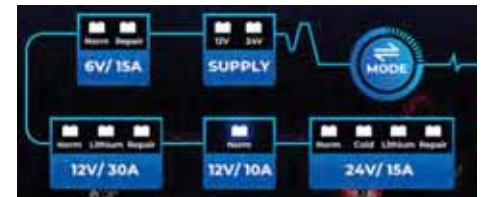

Bench Chargers

6/12V, 1A Maintainer
SKU 765478 ASC9003A **69⁹⁹**

- LED Lights Indicating Charging Status
- Includes 2 Sets of Charging Leads
- OEM Vehicle Manufacture Approved
- Safe for AGM, Gel Cell, SLA Batteries
- Reverse Polarity Protected
- Overcharge Protection
- 1 Year Warranty



6/12V, 15/2A Smart Bench Top Charger
SKU 850634 ASC3100A **199⁹⁹**

- Digital Display Shows Charging Voltage/Amperage or Time Remaining
- Safe for AGM, Gel Cell, SLA Batteries
- 100A Boost
- 1 Year Warranty

ASSOCIATED



AUTEL MAXIBAS BATTERY & ELECTRICAL ANALYSIS

MaxiBAS® BT609

SKU #1125832 | Part #BT609

- Adaptive Conductance Technology: Produces a More Accurate Exam of the Battery's Status
- All System Scan, Read and Clear Codes
- Complete Service Menu 20+ Functions



MaxiBAS® BT608

SKU #1105501 | Part #BT608

- Adaptive Conductance Technology: Detects Battery Capacity Reducing Misdiagnosis
- Auto Battery Reset / Print Test Reports Via Built-in Thermal Printer
- AutoSCAN/VINScan for Quick Vehicle Identification & Battery Specifications



MaxiBAS® BT506

SKU #1125835 | Part #BT506

- Use with Smartphone or other Smart Device
- Support In-vehicle and Out-of-Vehicle Testing of Passenger Vehicle Batteries
- Test 6- and 12-volt Batteries: 100 - 2000 CCA
- Test 12- and 24- Cranking/Charging Systems
- Test Flooded, AGM, AGM Spiral, EFB & GEL Batteries



OBDII EXTENSION CABLE

SKU #1443473 | Part #VCIEXTCAB

- Compatible with all OBDII-compliant VCIs
- It keeps VCI in sight and is easy to retrieve and not forget after use



MaxiBAS® BTAK

SKU #1149588 | Part #BTAK

- Battery Tester Accessory Kit
- Digital Multimeter and Current Clamp Kit
- Measures Voltage, Current and Resistance



MaxiBAS® BTMS

SKU #1149587 | Part #BTMS

- Battery Tester Memory Saver
- Preserves Vehicle Codes and Electronic Presets When Replacing Battery
- Enables Vehicle Computer to Be Powered and Maintain Data When Connected to Backup Vehicle Battery



AUTEL MAXIEV ADVANCED EV DIAGNOSTICS

NEW EV RELEASE

MaxiEV® ALT100L

SKU #1442217 | Part #ALT100L

- Tests high voltage battery enclosures and high voltage thermodynamics systems such as coolant and A/C for leaks
- High-sensitive pressure sensing significantly improves test accuracy and stability
- Dual Pressure Display: Real-time display of current pressure and leakage fluctuations



MaxiEV® CDT100

SKU #1443474 | Part #CDT100

- Wide-voltage design, suitable for discharge, charge, and activation testing of modules with different voltage levels
- Set constant current and power, Charge and Discharge modes for varied applications
- Displays single-cell maximum/minimum voltage and other data onscreen in graphs, columns, and report forms



MaxiEV® ITS100

SKU #1442216 | Part #ITS100

- Tests high voltage wiring and components
- Test resistance measurement before loading into the vehicle
- Helps identify issues like damage, deterioration, or contamination of the insulation



CALL FOR PRICE

AUTEL

Prices subject to change without notice. Prices do not include applicable taxes, vehicles, tires, rims, installation or optional equipment as shown. Please do not return purchases to the store. For information regarding warranty, repair, or any questions or concerns, call 901-300-4878.

HEATING & COOLING

TO ORDER, contact your Commercial Sales Manager or go to AutoZonePro.com

HEATING & COOLING

EnergyLogic

On-board
air compressor

Burn No.2 to 90W
and synthetics

Small
footprint

Stop paying to have your waste oil hauled off!
Save and burn it for FREE heat this winter.



ENL11075104

75H Waste Oil Furnace with Built-In 10 Gal. Tank

FURNACE	BTUs	HEATS UP TO	PART NO.	PRICE
EL-75	75,000	1,750 Sq. Ft.	ENL11075104	4,299.99

Waste Oil Heater Complete Systems*

FURNACE	BTUs	HEATS UP TO	PART NO.	PRICE	Reg. Price	Savings
EL-140	140,000	3,500 Sq. Ft.	ENL01140103	11,349.99	11,999.99	\$650
EL-200	200,000	5,000 Sq. Ft.	ENL01200104	12,599.99	13,349.99	\$750
EL-350	350,000	8,500 Sq. Ft.	ENL01350104	15,599.99	16,549.99	\$950

* Complete systems include waste oil furnace and 250 gallon tank, swing-away burner with built-in air compressor, low-fuel cutoff, draft gauge, drain valve and Class A flue kit.

FOR BEST PRICING,
Call 901-300-4878

Not for Sale in CA



ENL01140103

Lanair

EXTREME PERFORMANCE BURNER

FREE Strainer Pan & Tank Gauge Included!

	Heater Package*	BTUs	Heats up to	Part Number	Price
<i>Thru-roof chimney</i>	XT150C	150,000	3,500 Sq. Ft.	LANXT150C	10,449.99
	XT200C	200,000	5,000 Sq. Ft.	LANXT200C	10,799.99
	XT250C	250,000	8,500 Sq. Ft.	LANXT250C	13,849.99
	XT300C	300,000	10,00 Sq. Ft.	LANXT300C	14,599.99

* Packages Include 215 Gallon Tank and 6" Chimney Kit

Not for Sale in CA



LANXT150C

Sunfire

Portable Radiant Heaters

- Built-In Safety Features – Equipped with Tip-Over Protection, Flame-Out Sensors, and Automatic Shutoff Systems to Ensure Safe Operation in Commercial and Indoor Settings
- Infrared Radiant Heating: Clean, Quiet, and Odorless
- Built for Portability
- Thermostat-Ready and UL-Listed for Indoor/Commercial Use
- Made In the USA with Strong Support

NO SMELL  NO FUMES



Part Number	BTU's	Heats up to	Fuel	Tank	Price
SFRSF80	80,000	1,900 Sq. Ft.	Dual Fuel (Diesel/Kerosene)	6 Gal.	1,799.99
SFRSF120	120,000	2,800 Sq. Ft.	Dual Fuel (Diesel/Kerosene)	14 Gal.	2,499.99
NEW SFRSF160	160,000	3,500 Sq. Ft.	Dual Fuel (Diesel/Kerosene)	19 Gal.	3,499.99



SFRSF120

To Confirm Price, Availability and Ordering Instructions on OSB, Call 901-300-4878

Prices subject to change without notice. Prices do not include applicable taxes, vehicles, tires, rims, installation or optional equipment as shown. Please do not return purchases to the store. For information regarding warranty, repair, or any questions or concerns, call 901-300-4878.

AZG0425

HEATING & COOLING

Exhaust Hoses

Flarelock Hoses

- Made Exclusively for Cars and Small Trucks
- End is Flared to Permit Connection of 2 or More Links at a Time

2.5" x 11'
SKU 977557
ACSFLT250 **129⁹⁹**

3.5" x 11'
SKU 977589
ACSFLT350 **224⁹⁹**

3" x 11'
SKU 977559
ACSFLT300 **159⁹⁹**

4" x 11'
SKU 977590
ACSFLT400 **244⁹⁹**



3" Y-Assembly Kit with
F300 Adapter
SKU 977550
ACSYA300
264⁹⁹



Door Port Adapters

For 2.5" Hose (Rubber)
SKU 977551
ACSDF25 **59⁹⁹**

- Rubber Garage Door Port Adapter
- Designed for 2-1/2" ID



For 3" Hose (Aluminum)
SKU 977552
ACSADF30 **59⁹⁹**

- Aluminum Port Allows Hose to Be Vented Through the Door



For 4" Hose (Aluminum)
SKU 977554
ACSADF40 **89⁹⁹**

- Use on 1" Thick Doors



2.5" Service Station Kit

SKU 977547
ACSDSS25 **274⁹⁹**

- 2 Each - 4' x 2-1/2" Hoses
- 1 Each - 6' x 2-1/2" Hose
- 1 Each - 2-1/2" Rubber "Y" Connector
- 2 Each - Straight Tailpipe Adapter, Hook and Chain
- 1 Each - Splice Connector



3" Service Station Kit

SKU 977548
ACSDSS30 **279⁹⁹**

- 2 Each - 4' x 3" Hoses
- 1 Each - 6' x 3" Hose
- 1 Each - 3" Rubber "Y" Connector
- 2 Each - Straight Tailpipe Adapter, Hook and Chain
- 1 Each - Splice Connector



Bell Hose Adapters

- Designed for Easy Adapting to All Sorts of Tailpipes
- Connects with Ball and Snap

2.5" Adapter
SKU 977544
ACSRA250 **59⁹⁹**

3" Adapter
SKU 977545
ACSRA300 **59⁹⁹**



SYLVANIA

#1 AFTERMARKET AUTOMOTIVE LIGHTING BRAND IN THE USA¹

¹Circana/U.S. Retail Tracking Service, March 2, 2024
²See packaging for details ³Compared to SYLVANIA BASIC

LED OFF ROAD LIGHTBARS + PODS



SYLVANIA LED OFF ROAD LIGHTS



LIFETIME LIMITED WARRANTY²
Superior optical engineering
Durable design
Water resistant (IP67 or IP69K)

UPGRADE YOUR HEADLIGHTS + FOG LIGHTS

SYLVANIA LED



5 YEAR LIMITED WARRANTY²

Performance, Longevity + Style

PART NUMBERS:
9003 | 9005 | 9006 | 9007 |
9012 | H1 | H7 | H8 | H9 |
H11 | H13 | H16

Powersport headlight or fog light use only

SILVERSTAR ULTRA



FARTHEST DOWNROAD + WHITER LIGHT³



SILVERSTAR



FARTHER DOWNROAD + WHITER LIGHT³

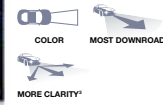

XTRAVISION



FARTHEST DOWNROAD³

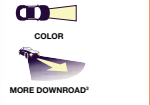

EXPERIENCE THE DIFFERENCE OF

LED



NEW! SYLVANIA LED SEALED BEAM LAMPS

5 Year Limited Warranty²
Direct replacement
DOT compliant
Engineered with OEM grade OSRAM LEDs

Available Part Numbers: H6024 | H6054
Additional part numbers coming soon

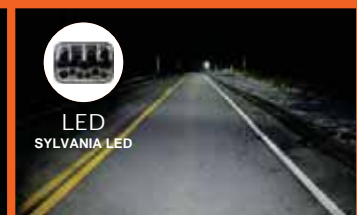

Raise Productivity

Unique high efficiency propeller design is quiet and delivers airflow over long distances.

Keep your technicians cool and comfortable.



Evaporative Coolers

5300 CFM
SKU 213172 23969 **799⁹⁹**

- 1/3 HP 3 Speed Motor
- Water Capacity: 14.6 Gallons
- Cooling Area: 1,600 Sq. Ft.
- Dimensions: 45" x 17" x 28"
- Weight: 56 Lb.

3100 CFM
SKU 213184 23968 **599⁹⁹**

- 1/5 HP 3 Speed Motor
- Water Capacity: 10.3 Gallons
- Cooling Area: 950 Sq. Ft.
- Dimensions: 37" x 17" x 25"
- Weight: 39 Lb.

Replacement Media Sets

For 23969/23977
5300 CFM
SKU 1485036 HESCP610 **129⁹⁹**

For 23968/23976
3100 CFM
SKU 1485034 HESCP370 **89⁹⁹**



Shop Fans

- Powerful 3-Speed Motor
- Easy to Assemble and Wall Mountable
- Oscillating Function Provides Effective Air Circulation



24" Indoor Fan
SKU 592383 OEM24883 **249⁹⁹**

- CFM: 6500

30" Indoor Fan
SKU 592385 OEM24884 **279⁹⁹**

- CFM: 9500

24" Outdoor Fan
SKU 949553 OEM24893 **299⁹⁹**

- CFM: 6800
- IP44 Water Resistance Rating

30" Outdoor Fan
SKU 949582 OEM24894 **349⁹⁹**

- CFM: 7200
- IP44 Water Resistance Rating

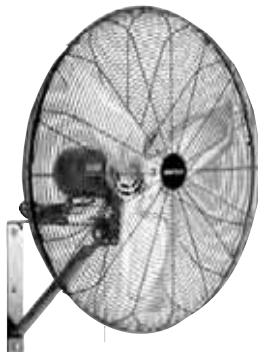

20" **OEM TOOLS**
SKU 688197 OEM24871 **134⁹⁹** REG. \$184.99

- CFM: 4500
- 5 Aluminum Blades
- 6' UL Listed Power Cord

SAVE \$50



Offer Good While Supplies Last Through December 31, 2025

Floor Fan



20" High Velocity Floor Fan
SKU 688200 OEM24870 **69⁹⁹**

- CFM: 4500
- Precision-Balanced Aluminum Fan Blades and Energy-Efficient Motor Optimize Airflow Output
- 3-Speed Motor Allows Operator to Control Airflow Volume
- 5' UL Listed Power Cord



HEATING & COOLING

PORTACOOOL

PEAK COOLING, INTELLIGENT CONTROL

- Portacool APEX™ Series
- Setting the STANDARD for Auto Shop Cooling
- HydroTek™ Evaporative Media – designed to MAXIMIZE cooling performance with less maintenance
- Control Your Comfort with COOLSYNC™ – Sync your Portacools to your smartphone for intelligent control
- Fan Speed
- Wind Direction
- Water Control
- Group Syncing
- Scheduling



PRCA05001A1

Apex 500
SKU 1392317
PRCA05001A1 **1,099⁹⁹**

- Cooling: Up to 500 Sq. Ft.
- Velocity: 40 MPH
- Air Flow Reach: 55 Ft.
- Water: 13 Gal.

Apex 700
SKU 1392315
PRCA07001A1 **1,599⁹⁹**

- Cooling: Up to 700 Sq. Ft.
- Velocity: 37 MPH
- Air Flow Reach: 60 Ft.
- Water: 22 Gal.



PRCA12001A1

Apex 1200
SKU 1392332
PRCA12001A1 **2,399⁹⁹**

- Cooling: Up to 1200 Sq. Ft.
- Velocity: 25 MPH
- Air Flow Reach: 40 Ft.
- Water: 40 Gal.

Apex 2000
SKU 1392329
PRCA20001A1 **3,199⁹⁹**

- Cooling: Up to 2000 Sq. Ft.
- Velocity: 28 MPH
- Air Flow Reach: 60 Ft.
- Water: 45 Gal.



PRCA65001A1

Apex 4000
SKU 1392335
PRCA40001A1 **3,799⁹⁹**

- Cooling: Up to 4000 Sq. Ft.
- Velocity: 25 MPH
- Air Flow Reach: 50 Ft.
- Water: 55 Gal.

Apex 6500
SKU 1392341
PRCA65001A1 **4,999⁹⁹**

- Cooling: Up to 6500 Sq. Ft.
- Velocity: 24 MPH
- Air Flow Reach: 40 Ft.
- Water: 66 Gal.



Customer Responsible For Offloading, Liftgate Service Available | We Offer the Full Line of Portacool and Cool Boss Evaporative Coolers and Accessories

Evaporative Coolers



- 80W 4000 Lumens Adjustable LED Floodlight
- Anion Negative Ion Air Purifier
- Low Level Shutoff
- Built-In Bluetooth® Audio Player and Speakers
- Wireless Remote Control

CB-12L
SKU 1360694
CLBCB-12SL **1,559⁹⁹**

- Max. Airflow: 1,565 CFM
- Cooling Area: 650 Sq. Ft.
- Fan Diameter: 12"

CB-14L
SKU 1400037
CLBCB-14SL **1,829⁹⁹**

- Max. Airflow: 2,300 CFM
- Cooling Area: 850 Sq. Ft.
- Fan Diameter: 14"

CB-16L
SKU 1275460
CLBCB-16L **2,799⁹⁹**

- Max. Airflow: 4,950 CFM
- Cooling Area: 1,125 Sq. Ft.
- Fan Diameter: 16"

CB-28L
SKU 1275461
CLBCB-28L **3,799⁹⁹**

- Max. Airflow: 9,020 CFM
- Cooling Area: 2,125 Sq. Ft.
- Fan Diameter: 28"

CB-36L
SKU 1275465
CLBCB-36L **4,899⁹⁹**

- Max. Airflow: 12,615 CFM
- Cooling Area: 3,125 Sq. Ft.
- Fan Diameter: 36"



CLBCB-16L

Blower Fans



300 CFM Blower Fan
SKU 1392323
MSC20300-A **139⁹⁹**

- 120 Volts, 60 Hz
- For Indoor or Outdoor Use
- 3-Speed Switch (High, Medium, Low)
- 4-Position Adjustment Feet
- 8.5 Ft. Cord Length



Heater Attachment
for 300 CFM Blower
SKU OSB
MSC20300-HTR **79⁹⁹**

- Converts Your 300 CFM Portable Blower into a Heater for Your Garage or Work Space
- 1320 Watts, 5000 BTU
- Fits Many Popular Brands (300 CFM Only. Not for 1,200 CFM Fans.)



For OSB, Call 901-300-4878

ALLDATA®

ALLDATA REPAIR® & COLLISION + ALLDATA ESTIMATOR

Fast-Track Estimates & Order AutoZone® Parts

NEW!
ALLDATA ESTIMATOR
NOW **INCLUDED**
WITH YOUR
SUBSCRIPTION

- Quickly create professional, compliant estimates
- Easily add parts & labor costs directly from ALLDATA Repair or Collision
- Store customer and vehicle data, including custom jobs
- Customize the estimate with your shop's logo
- Order AutoZone parts directly from the catalog

(888) 726-3211

For our latest pricing and promotions visit
ALLDATA.com

©2025 ALLDATA LLC. ALLDATA, Automotive Intelligence, ALLDATA Repair, ALLDATA Collision, ALLDATA Diagnostics, ALLDATA Shop Manager, ALLDATA Tech-Assist and ALLDATA Mobile are registered trademarks and ALLDATA Manage and ALLDATA Community are marks of ALLDATA LLC. AutoZone is a registered trademark of AutoZone IP LLC. All other marks are property of their respective owners.

DIAGNOSTICS

TopDon

6" Bluetooth Scan Tool with Service Functions and CAN-FD

SKU **OSB**
TPDAD800BT2 **399⁹⁹**

- FCA SGW Support
- 28+ Special Services for Your Productive Days
- Wider Coverage, Faster Solutions
- Cut the Cord, Work Without Limits
- All Systems Covered, All Issues Addressed
- Real-Time Performance Tracking with Live Data
- Effortless Organization, Ergonomic Excellence
- Identify, Record, and Share with Ease
- Take Advantage of the Feedback Feature to Communicate Any Issues You Encounter



For OSB, Call 901-300-4878

T-Ninja Pro Key Programming Via OBD2

SKU **1340225**
TPDNINJAPRO **499⁹⁹**

- Pin Reading and Key Learning
- Remote Control Learning
- Deletes Keys
- All Keys Lost
- Reads and Clears Fault Codes
- Supports Wireless and Wired Dual Connectivity

TOPDON[®]



Phoenix Smart Diagnostic System

SKU **1331482**
TPDPXSMART **2,199⁹⁹**

- Android Based OE-Level Coverage
- 10.1" HD Touch Screen
- TOPOLOGY Feature for Enhanced Diagnostics
- SmartLink VCI - Adds CanFD, DoIP, J2534, RP1210
- Codes/Data/Bi-Directional/Special Functions/Coding/Programming



Phoenix Max Diagnostic System

SKU **1331492**
TPDPXMAX **3,799⁹⁹**

- Includes A 4-Channel Oscilloscope
- Supports Cloud-Based Programming For 9+ Brands, Including: Mercedes-Benz, BMW, Audi, Volkswagen/Skoda/Seat, Porsche, Jaguar/Land Rover, Nissan, Subaru and Renault
- Supports 9V to 24V Vehicle Models, Configuring Both Passenger Cars and Heavy Trucks
- Heavy Duty Housing with IP65 Standards
- Auto VIN Technology Automatically Uses the Right Diagnostic Software After Identifying the Vehicle Through Its VIN



UltraDiag 2-in-1 Diagnostic Scanner and Key Programmer

SKU **1368629**
TPDULTRADIAG **699⁹⁹**

- Full-System Diagnostics
- 8 Reset Functions: Oil, Throttle Adaptation, EPB, Steering Angle, DPF Regeneration, ABS Bleeding, BMS and Airbag
- Key Programming Functions: Number of Keys, PIN Reading, Key Learning, Remote Control Learning, Delete Keys and All Keys Lost



Transponder and Remote Tester Tool

SKU **OSB**
TPDT-DARTS **44⁹⁹**

- Allows Either USB or Battery Powered Function
- Supports Transponder Chips
- Supports 100+ Transponder Chips
- Includes: Quick Guide and a USB Type-C Cable



For OSB, Call 901-300-4878

Heavy-Duty Non-16 Pin Cable Kit

SKU **OSB**
TPDHDCKIT **154⁹⁹**

- Includes: OBD-9, OBD-6, OBD-16, IVECO-38, IVECO-30, BENZ-14, MAN-12, MAN-37, ISUZU-3, ISUZU-20, RENAULT-12, VOLVO-8PIN, and CAT-9



For OSB, Call 901-300-4878

SHARED SERVICE FUNCTIONS

- | | | | |
|---------------------------------|---|-----------------------------|---------------------------------|
| OIL RESET | THROTTLE | AIRBAG RESET | A/C |
| EPB - ELECTRONIC PARKING BRAKE | ABS/SRS | CLUTCH | RAIN/LIGHT SENSOR |
| BMS - BATTERY MANAGEMENT SYSTEM | VGT LEARN | RESOLVER SENSOR CALIBRATION | RESET CONTROL UNIT |
| SAS - STEERING ANGLE SENSOR | RELATIVE COMPRESSION WINDOW / DOOR / ROOF SEATS | AUTOMATIC START/STOP | CCS/ACC |
| IMMO KEYS - IMMOBILIZER & KEYS | ODOMETER | ELECTRONIC WATER PUMP START | VIN |
| BRAKE BLEED | LANGUAGE CHANGE | EGR | COOLANT/REFRIGERANT CHANGE |
| DPF - DIESEL PARTICULATE FILTER | HEADLAMP | FRM RESET | SUNROOF INITIALIZATION |
| INJECTOR | CHG TIRE SIZE | TRANSPORT MODE | TEC LEARN |
| SUSPENSION | SPEED & PTO CYLINDER | HV BATTERY | HV DE-ENERGIZATION/ENERGIZATION |
| | TRANS ADAPTION | ACC | ALL SYSTEM AUTO-SCAN |



MaxiCheck[®] MX900
 SKU #1369200 | Part #MX900



MaxiTPMS[®] TS900
 SKU #1337325 | Part #TS900



MaxiBAS[®] BT609
 SKU #1125832 | Part #BT609

	MAXICHECK MX900	MAXITPMS TS900	MAXIBAS BT609
OPERATING SYSTEM	ANDROID 11	ANDROID 11	ANDROID 9
SOFTWARE UPDATES	1 YEAR FREE	1 YEAR FREE	1 YEAR FREE
AUTOMATIC DETECTIONS	AUTO-VIN/SCANVIN	AUTO-VIN/SCANVIN	AUTO-VIN/SCANVIN
VEHICLE COVERAGE	US, ASIAN & EUROPEAN 1996+	US, ASIAN & EUROPEAN 1996+	US, ASIAN & EUROPEAN 1996+
OBDII TEST MODES	PERFORM BI-DIRECTIONAL ACTIVE TESTS AND SPECIAL FUNCTIONS	PERFORM BI-DIRECTIONAL ACTIVE TESTS AND SPECIAL FUNCTIONS	PERFORM BI-DIRECTIONAL ACTIVE TESTS AND SPECIAL FUNCTIONS
DIAGNOSTICS & SERVICE	ALL SYSTEMS / 40+ SERVICES	ALL SYSTEMS / 40+ SERVICES	ALL SYSTEMS / 40+ SERVICES
VEHICLE CONNECTIVITY	CORDED	BLUETOOTH VCI	BLUETOOTH VCI
TPMS DIAGNOSTICS	-	INCLUDED WITH ENHANCED TPMS STATUS SCREEN	-
TPMS SENSOR COMPATIBILITY	-	AUTEL BLE SENSOR FOR TESLA + PROGRAM AUTEL MX-SENSOR 1-SENSORS	-
BATTERY TESTING	-	-	INCLUDED

CALL FOR PRICE

AUTEL[®]

Smoke Leak Detectors

Smoke Pro® Total Tech Smoke Machine

SKU OSB
RED95-0050 **1,199⁹⁹**

- Pinpoint Leaks as Small as 0.0010"
- Rechargeable LED Inspection Light
- Field Replaceable Smoke Hose
- Refined Flow Meter Callout Heavy Duty Flow Control Valve
- Includes: Easy Intake and Easy Connect



For OSB, Call
901-300-4878

REDLINE
DETECTION.COM



Made in USA

Smoke Pro Air™

SKU 1340239
RED95-0075 **1,399⁹⁹**

- Ideal for Performing Diagnostics on the Evap Systems of Naturally-Aspirated Vehicles
- Features an Onboard Micro Air Compressor for Total Portability and Includes All Needed Accessories
- Uses OEM-Approved Fluid to Produce a Visual Vapor That is Free of Dyes and Contaminants
- Detects Leaks as Small as 0.010" and Performs Air Leak Decay Test



REDLINE
DETECTION.COM



Made in USA

ReadySmoke™ Leak Detector

SKU 744010
RED95-0400 **749⁹⁹**

- Pinpoint Intake, Exhaust and Other EVAP Leaks In Minutes
- Flow Meter Identifies Minute Leaks at and Below .010" in Diameter
- Easy Fill Dipstick Style Fluid Port
- Includes: (2) 2 Oz. OEM-Approved Vapor Producing Fluid, EVAP Service Tool Kit, Halogen Inspection Light, Cap Plug Kit, Standard Cone Adapter and Storage Case



REDLINE
DETECTION.COM



Made in USA

Intake Inflatable Block Off Bladder

OEM TOOLS

SKU 598274
24536 **89⁹⁹** REG. \$99.99

SAVE \$10

- Conforms to Any Shape
- Intake/Exhaust: Square, Round, Oval or Rectangular
- Works with Most Automobiles and Light, Medium and Heavy Duty Trucks
- Replacement Bladder Available



Use with All Smoke Machines
Offers Good While Supplies Last Through December 31, 2025

EasyConnect® Test Kit

SKU 1189091
RED96-0190 **109⁹⁹**

- Forms a Complete Seal for Effective Leak Testing without Disturbing Other Components
- Comes in a Compact and Durable Storage Case
- Compatible with Any Smoke Machine
- Includes: 4 Different Sized Adapters with 4 Add-On Components



REDLINE
DETECTION.COM



Made in USA

Easy INTAKE™

SKU 696477
RED95-0082 **169⁹⁹**

- Compatible with Any Smoke Machine
- Block Off Bladder Conforms to Any Shape Intake/Exhaust



REDLINE
DETECTION.COM



Made in USA

Smoke Producing Fluid (8 Oz.)

SKU 802333
RED96-0039 **29⁹⁹**

- Contains No Dye or Other Contaminants
- Works in Most EVAP Smoke Machines



REDLINE
DETECTION.COM



Made in USA

EasyEVAP™ Universal Filler Neck Connector

SKU 343405
RED95-0030 **124⁹⁹**

- Compatible with Any Smoke Machine and Removes Cleanly from the Gas Cap
- Essential Tool for Late Model Cars with Fuel Tank Rollover Valves



REDLINE
DETECTION.COM



Made in USA

Digital Dual Smoke Machine

SKU OSB
MSC43066 **1,599⁹⁹**

- High-Precision Gas Pressure Sensor Ensures Accurate Data
- 3 Built-In High-Power Air Pumps, Offers Faster and Thicker Smoke Generation
- Pressure Regulated at 0.44-0.5 psi for Safe EVAP Testing, Maximum Out 20 psi for High Pressure Testing
- Accessories Include: Full Set of Block Off Caps, Schrader Valve Remover/Installer, Service Port Adapter Hose, 2 Oz. Smoke Producing Fluid and Bladder for Intake Testing



Mastercool®
"World Class Quality"

For OSB, Call
901-300-4878

Evap Diagnostic Smoke Machine

SKU OSB
MSC43060EV **1,149⁹⁹**

- Multiple Options for Smoke Injection Include Built-In Internal Compressor, Shop Air and Inert Gases
- Pressure Decay Gauge 0-30" H2O (70 mbar)
- Flow Meter: 0 to 0.040" (0 to 1.0 mm)
- Input Pressure: Max. 100 psi (8.2 bar)
- Built-In Pressure Regulated at 0.5 psi



Mastercool®
"World Class Quality"

For OSB, Call
901-300-4878

DIAGNOSTICS

Diagnostic

Compression Tester Gauge Set
SKU 1103601 37138 **39⁹⁹**

- Use to Test Compression 0 to 300 psi on 14 mm and 18 mm Spark Plug Ports and Determine Engine Mechanical Condition



8 Piece Noid Light Set
SKU 1103589 37161 **29⁹⁹**

- Includes: GM TBI, GM SCPI, GM PFI, Ford TBI, GEO TBI, Bosch PFI, Bosch Type 2 and GM Multec 2
- See-Through Design to Check Electrical Pulses



Automotive Tune-Up and Brake Bleed Kit
SKU 466495 25138 **36⁹⁹**

- Includes Components to Diagnose and Service Vacuum and Pressure-Related Systems
- Tests Distributor Vacuum, Power Brakes, Carburetor Chokes, EGR Valves Along with Other Sensors and Components
- Enables One-Person Brake Bleeding with Minimal Spills



Exhaust Back Pressure Tester/Gauge
SKU 1103604 37263 **79⁹⁹**

- Oxygen Sensor Adapter is M12 and M18 Thread
- 6' Hose Allows User to Test from Driver's Seat
- Test for Restricted Exhaust Systems



Oil Pressure Gauge Set
SKU 347229 27262 **44⁹⁹**

- For Use on Diesel and Gasoline Engines
- Includes Standard and Metric Adapters Found on Most Cars and Trucks
- 2-1/2" Easy-to-Read Gauge with Protective Boot
- Range: 0-100 psi, 0 to 7 Bar



AUTEL MAXISYS ULTRA S2

ANOTHER LEAP FORWARD

NEW



6-in-1 VCM12

MaxiSYS[®] MSULTRA S2
SKU #1540763 | Part #MSULTRAS2

Built on its award-winning predecessor, the Autel MaxiSYS Ultra, the Ultra S2 sets a new benchmark for efficiency and accuracy with upgraded hardware and advanced diagnostic features that deliver near OEM-level diagnostics and service capability.

Data-Driven Diagnostics with Enhanced PID Analysis

Data Visualization: Enhanced graphing capability to visualize multiple parameters to identify the relationship between PIDs and pinpoint system anomalies.

Live Data Fusion: Record and compare value changes across multiple systems.

Parameter Grouping: Multi-PID selection for analyzing related parameters simultaneously. Ideal for engine fault and performance and emissions troubleshooting.

Reference Sampling: Record, store, and review selected PIDs for pre- and post-repair comparison that will flag min, max, and average.

Real-Time, Split-Screen Analysis: Access the oscilloscope directly from the current Live Data screen.

SCAN FOR FULL ULTRA S2 DETAILS
OR VISIT: AUTEL.US/ULTRA-S2



MaxiVIDEO[®] MV480
SKU #1137680 | Part #MV480

- Record/Playback Images & Videos
- 4.1" Color LCD Display
- Dual Front and Side Cameras for Wider Viewing Angle

MaxiVIDEO[®] MV460
SKU #1089243 | Part #MV460

- 3.5" Color LCD Display

AutoLINK[®] AL549 | SKU #789375 | Part #AL549

- Universal OBD II and ABS Code Reader
- Read & Erase Codes, View Freeze Frame and Live Data
- Supports all 10 Modes of OBD II
- Compatible with U.S., Asian, and European vehicles, 1996 & Newer



AutoLINK[®] AP2500

- Read/erase codes, view Freeze Frame & Live Data, perform Emissions test
- Includes Bluetooth dongle for vehicle connection. Download FREE MaxiAP Diag app

• Vehicle health check includes engine oil life, average fuel consumption, and brake pad life.

• All Systems diagnostics on first vehicle brand. Additional coverage can be added with in-APP purchase.

AutoLINK[®] AL329
SKU #103946 | Part #AL329

- Read/Eraser Engine DTCs
- One-Touch I/M Readiness /LED Indicator
- Display Live & Freeze Frame Data



MaxiSYS[®] ULTRA EV
SKU #1267097 | Part #MSULTRA EV

MaxiSYS[®] MS919
SKU #1093326 | Part #MS919

AUTEL
DIAGNOSTIC SOLUTIONS

MaxiSYS[®] MS909 EV
SKU #1267098 | Part #MS909 EV

MaxiSYS[®] MS909
SKU #109408 | Part #MS909

MaxiSYS[®] MSULTRA
SKU #1092018 | Part #MSULTRA



MaxiSYS[®] MS909CV
SKU #1174556 | Part #MS909CV

- For Class 1-8 Commercial Vehicles
- Topology Mapping on Select Models
- Engine Coverage for Construction & Agricultural Vehicles



MaxiSYS[®] MS906 MAX
SKU #1507706 | Part #MS906MAX

- 10.1-inch professional diagnostics and service tablet
- Perform all-systems diagnostics
- Bi-directional Active Tests and Special Functions

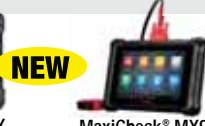

MaxiCheck[®] MX900
SKU #1369200

Part #MX900

- Read & Erase Codes
- Bidirectional Active Tests and Special Functions
- 40+ Function Service Menu



MaxiIM[®] IM608PROIHKPA
SKU #1336440

Part #IM608PROIHKPA

- IMMO and Key Programming Bundle
- Program IMMO & Keys for U.S., Asian, and European Vehicles
- IM608PROII Tablet, XP400Pro, Wireless JVCI, IMKPA Key Programming Adapter Kit



MaxiIM[®] IM508S
SKU #1442228

Part #IM508S

- Fast and Portable IMMO & Key Programming Tablet
- Includes the XP200 Key Programmer



MaxiIM[®] KM100
SKU #1242003

Part #KM100

- Advanced key and IMMO 5.5-in. touchscreen tablet with 2 IKEYS
- Program Autel's IKEY universal keys as smart key replacement for 3,000+ vehicles
- One-minute Key generation, Easy key button customization

CALL FOR PRICE

AUTEL

TEXA

Axone Light Car Diagnostic Kit (NANO)

SKU **OSB** **3,699⁹⁹**
 TEXAXLTAKN

The Navigator NANO S can perform diagnostic operations on all major brands of cars and light commercial vehicles. It is the perfect entry level scan tool for automotive repair shops.

- Axone Nemo Light Rugged Tablet
- Navigator NANO S VCI
- IDC5m Car Software License
- Rugged Carrying Case with Custom Foam
- Motor TruSpeed Repair included



Axone Light Car Diagnostic Kit (Multihub)

SKU **OSB** **4,999⁹⁹**
 TEXAXLTAKMH

The TXT MULTIHUB is TEXA'S flagship scan tool. It is IP53 Certified, can handle Doip, Can-FD, J2534/RP1210 protocols and more. Perfect for advanced diagnostics and shops that want the capability to work in more than one environment from the same device.

- Axone Nemo Light Rugged Tablet
- Navigator TXT Multihub
- IDC5m Car Software License
- Rugged Carrying Case with Custom Foam
- Motor TruSpeed Repair included



TruSpeed Repair



Both packages offer a complete diagnostics solution:

Access repair information (including torque specs, torque sequences, fluid type, capacities), read and clear codes, view live data, wiring diagrams, maintenance resets, adaptation value resets (engine, brake systems, transmission), cylinder tests, idle learning and much more.

WHY TEXA?

- Lifetime equipment warranty with active software subscription.
- Built by TEXA to the highest Tier 1 OEM standards.
- Secure Windows-based architecture, not Android.
- With TEXA, YOU own your data.
- Need help? You can rely on TEXA's U.S. based support team to be responsive and knowledgeable.

Try us! Call to set up a demo.

For OSB, Call 901-300-4878

AUTEL MAXISYS

IA1000 AUTOMATED WHEEL ALIGNMENT & ADAS CALIBRATION SYSTEM

FULLY ROBOTIC FORWARD-FACING CALIBRATIONS

The Autel IA1000 is an all-in-one ADAS calibration, wheel alignment, and advanced diagnostics system featuring robotic target positioning and laser-guided accuracy. Designed for efficiency, precision, and repeatability, it's the ideal solution for modern service centers.

IA1000 Automated ADAS Calibration & Wheel Alignment System

- Automated Alignment and ADAS Calibration System with robotic forward-facing camera target positioning, laser-guided ACC, blind spot calibrator and AVM mat placement capable of performing four-wheel alignment and ADAS calibrations.
- Includes three 27-inch attachable monitors and the Autel digital LDW target kit.
- Includes MaxiSYS Ultra S2 advanced diagnostics tablet with MaxiFlash VCI2 and IA1000 Alignment and ADAS software upgrade.
- Includes 24" touchscreen display that attaches to frame unit, four tire clamps, steering wheel and brake lock, distance target, two wheel chocks, and two AVM-placement lasers.
- Unit provides one-step robotic and vertical LDW target placement via physical targets or with the included 27-inch attachable monitors, significantly reducing manual operation and setup time.
- Automatic pitch, roll, yaw, and front-to-back fine-tuning robotic adjustments improve accuracy and reduce human error.
- Offers comprehensive four-wheel alignment coverage of U.S., Asian, and European vehicles.

IA1000+ DIGITAL LDW TARGETS

SKU #1573143 | Part #IA1000TDT
 • Includes digital targets (3 monitors) & digital target activation card

IA1000+ DIGITAL & PHYSICAL LDW TARGETS

SKU #1573140 | Part #IA1000LDWTD
 • Includes digital targets (3 monitors) & digital target activation card
 • Includes physical LDW Targets

IA1000 ALL SYSTEMS + DIGITAL & PHYSICAL LDW TARGETS

SKU #1573142 | Part #IA1000ASTDT
 • Includes digital targets (3 monitors) & digital target activation card
 • Includes physical LDW targets
 • Includes All Systems equipment

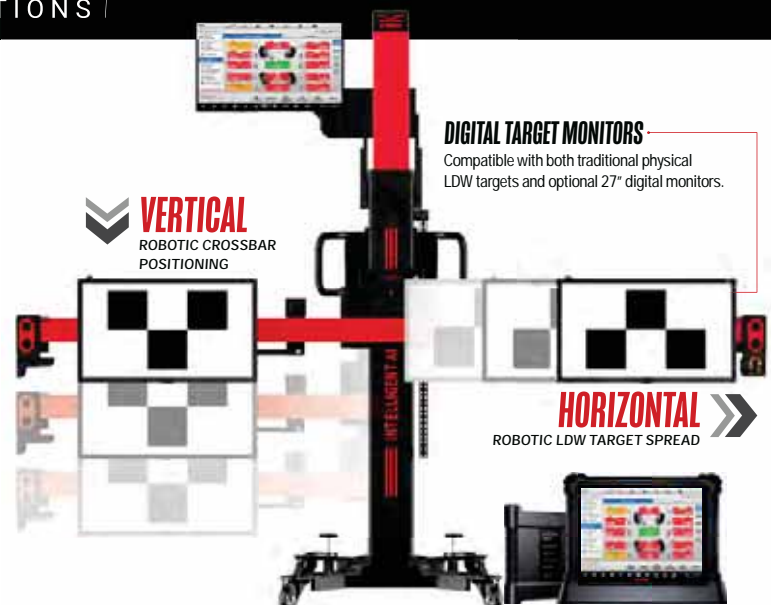

VERTICAL
 ROBOTIC CROSSBAR POSITIONING

DIGITAL TARGET MONITORS

Compatible with both traditional physical LDW targets and optional 27" digital monitors.

HORIZONTAL
 ROBOTIC LDW TARGET SPREAD

CALL FOR PRICE

AUTEL®

DIAGNOSTICS

Power Probe

Power Probe III with Case and Accessories

SKU **262523** **189⁹⁹**
PWPPP319FTC

Other Colors Available on AZTOOL1.com

- Relay and Component Tester
- Voltmeter and Continuity Tester
- Audio Tone
- 20' Jumper Lead
- Works on 12V to 24V Sources



Power Probe III with Lead Set

SKU **1330690** **269⁹⁹**
PWPPP3LS01

- Supplies Power and Ground
- Digital Voltmeter with Min./Max. Voltage Capturing
- 4 mm Banana Jack
- 20 Ft. Power Lead



Power Probe III Master Combo Kit

SKU **1105994** **429⁹⁹**
PWPPPKIT03S

- Power-Up Components
- Audible Monitoring of Electrical Signals Voltmeter
- 12V to 24V Range
- Bad Ground Indicator
- Continuity Tester
- Relay and Component Tester
- Trace Short and Open Circuits



Power Probe IV Master Kit

SKU **1330692** **499⁹⁹**
PWPPPKIT04

- Supply Power or Ground for Functional Component Testing
- Self-Resetting Thermal 8 Amp Circuit Breaker
- Multiple DC Volt Readings on the Same Display
- Quickly Determine if the Circuit is Open or is Shorted



Power Probe III Circuit Tester

SKU **1580942** **149⁹⁹**
PWPPP3CSRED

- Digital Voltmeter
- Continuity Tester
- 20' Jumper Lead Set
- Relay and Component Tester
- Removable Probe Tip Adapts to Any 4 mm Lead
- 2 Bright LED Lamps
- Quickly Supply Power and Ground to the Tip



Power Probe III Professional Electrical Test Kit

SKU **1330691** **339⁹⁹**
PWPPP3KIT01

- Supplies Power and Ground for Functional Component Testing
- CAT-IV 600V Hybrid Safe AC/DC Voltmeter
- Measures Resistance to 60M Ohms
- Measures Current from .001 Amps to 10 Amps



Power Probe IV with Case and Accessories

SKU **802331** **309⁹⁹**
PWPPP401AS

- Supplies Power and Ground for Functional Component Testing
- Digital Volt and Ohmmeter for Circuit Testing
- Large Color LCD Screen with Easy to Navigate User Menu
- AC-RMS, AC Peak-to-Peak, Frequency and Pulse Width for Signal Testing
- Fuel Injector Tester for Easy Circuit Diagnosis
- PCM/ECM Driver Supplies Safe Voltage for Testing Circuits



Reprogrammers

Programmer and Power Supply Bundle

SKU **OSB**
TPDRLINKBNDL

Simplify Your Diagnostic Process and Elevate Your Capabilities

- Highly Compatible with OE-Level Diagnostic Software for Performing Diagnostic, Programming and Coding Tasks
- One-Click Installation of OE-Level Diagnostic Software Drivers and Online Upgrades
- ECU Programming Voltage Stabilizer
- Suitable for All Types of 12V and 24V Lead-Acid Batteries, with a Wide Battery Capacity Range from 5 to 90 Amps
- Includes: T90000 Smart Battery Charger/Power Supply, T90DC Tornado90000 9.5' DC Cable Extension and RLINKLITE J2534 Compliant Passthrough Programming Device



TOPDON®

1,399⁹⁹

REG. \$1,749.97

SAVE **\$349**
 OVER
 When You Buy the Kit

For OSB, Call 901-300-4878

Prices subject to change without notice. Prices do not include applicable taxes, vehicles, tires, rims, installation or optional equipment as shown. Please do not return purchases to the store. For information regarding warranty, repair, or any questions or concerns, call 901-300-4878.

DIAGNOSTICS

TO ORDER, contact your Commercial Sales Manager or go to AutoZonePro.com

DIAGNOSTICS

LANG

TU-113PB Fuel Injection Pressure Tester
SKU **1330689** **89⁹⁹**
LNGTU-113PB

- Works on Most Domestic and Import Vehicles



TU-550 Master Fuel Injection Pressure Tester
SKU **1330693** **659⁹⁹**
LNGTU-550

- Covers All Domestic and Foreign Platforms 1988 to Present



Does Not Include Cis and TBI Adapters

Cylinder Leakage Tester with 2 Gauges - 100 psi
SKU **1580933** **119⁹⁹**
LNGCLT-2

- 2 Gauges: 1 for Compression Reading and 1 for Shop Air
- Easy Adjustable Regulator
- Protective Boots for Gauges
- Additional Adapters Available
- Includes: Storage Case



Fuel System Cleaners

MOTORVAC

Carbon Clean 1000
SKU **OSB** **2,149⁹⁹**
MVC500-0220

- Complete, Through the Rail, Fuel System Decarbonizing Service
- Fuel Rail Hookup Provides the Most Effective Results
- Online Application Guide
- Unique Time Saving Adapter System
- Cleans Fuel Injectors, Combustion Chamber and Intake Valves
- Works with MV5 (400-0050) Fuel System Cleaner



MV5 Press Gas/Petrol Fuel System Cleaner 17 Oz. (6 Pk.)
SKU **OSB** **129⁹⁹**
MVC400-0050

SUR&R®

S-Hook Sprayer
SKU **1149152** **74⁹⁹**
SURS-TOOL

- Nozzle End Produces Fine Mist Spraying Action for Thorough Cleaning of the Air Intake
- Helps Improve Fuel Performance
- Removes Carbon Build-Up
- For Use with SURFIC203



Fuel Injection Cleaner Kit
SKU **1137808** **439⁹⁹**
SURFIC203

- Makes Connections Quickly and Easily Using S.U.R.&R.'s Exclusive Quick Connects
- Holds Up to 18 Oz. of Canister Cleaning Solution
- Cleans More Thoroughly Than Aerosol Methods
- Easy to Connect and Use with Shop Air
- For Top Engine and Throttle Body Cleaning



SUR&R

EV Tools - Contact Us for Additional EV Specialty Tools 901-300-4878

7 Pc. Pliers and Screwdriver Tool Set-1000V Insulated Pouch Set

SKU **OSB** **249⁹⁹**
KNP9K989825US

- Set Contains 4 Pliers and 3 Screwdrivers in a Roll-Up Nylon Material Pouch



KNIPEX

10 Pc. Pliers and Screwdriver Tool Set, 1000V Insulated

SKU **OSB** **299⁹⁹**
KNP9K989830US

- Set Contains 5 Pliers and 5 Screwdrivers in a Shock-Resistant Plastic Case

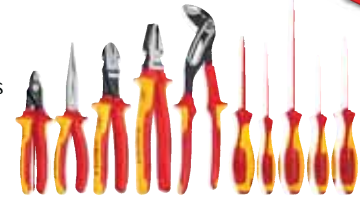

KNIPEX

10 Pc. Socket Set, 3/8" Drive, SAE, 1000V Insulated

SKU **OSB** **519⁹⁹**
KNP989911S3

- Includes 10 Insulated Tools for Working on Electrical Installations 3/8" Drive SAE in a Shock Resistant Plastic Case
- Foam Insert with Precise Recesses for Holding the Tools
- All Tools 100% Tested and Meet 1000V Insulated Requirements



KNIPEX

15 Pc. Tool Roll Bag, 1000V Insulated

SKU **OSB** **579⁹⁹**
KNP989913

- Includes 15 Insulated Tools for Working on Electrical Installations in a Roll Made Pouch Made of Hard-Wearing Polyester Fabric
- Pouch is Secured with a Quick Release Fastener Once Rolled Up
- All Insulated Tools Meet the Requirements of ASTM F1505



KNIPEX

Insulated VDE Combination Pliers

- Tested to 10,000 Volts AC for Maximum Safety
- GS/VDE Certification and Tested, Certified to 1000 VAC
- Individually Certified to EN 60900
- TPR Ergonomic Cushion Grips

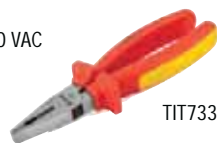

TITAN

TIT73328

6" SKU **OSB** **23⁹⁹** 7" SKU **OSB** **25⁹⁹** 8" SKU **OSB** **27⁹⁹**
TIT73326 TIT73327 TIT73328

10 Pc. Insulated Socket Set 1/4" Drive, Metric

SKU **OSB** **179⁹⁹**
WIH31393

- Insulated 1000 Volt Rated 10,000 Volt Tested
- Meets ASTM F1505
- Professional Series Long Life Insulated
- High Visibility Coatings on Sockets
- Double Covered Insulation Red Over Yellow
- Includes: 5 mm to 14 mm



wiha
Tools that work for you

To Confirm Price, Availability and Ordering Instructions on OSB, Call 901-300-4878

Prices subject to change without notice. Prices do not include applicable taxes, vehicles, tires, rims, installation or optional equipment as shown. Please do not return purchases to the store. For information regarding warranty, repair, or any questions or concerns, call 901-300-4878.

AZG0425

27

DIAGNOSTICS

Mityvac®

Professional Compression Test Kit

SKU **972276** **119⁹⁹**
MITMV5530

Everything You Need to Perform Cylinder Compression Tests on Motorcycles, Marine and Small Engines and an Air-Hold Adapter for Performing Valve Seal Repairs

- Adapters Include: 10 mm, 12 mm, 14 mm and 18 mm
- Extended Hoses for Hard-to-Reach Cylinders
- Large 2-3/4" Easy-to-Read Gauge
- Quick Disconnect Fittings



Silverline Elite Test Kit

SKU **988888** **144⁹⁹**
MITMV8500

- Provides Either Vacuum or Pressure with Equal Precision and Convenience
- Performs Engine Performance Diagnostics, Brake Bleeding, Fluid Transfer, Evacuation, Sampling and More
- Includes Components Needed to Perform Hundreds of Diagnostic and Mechanical Tests



Power Steering Adapter Kit

SKU **OSB** **89⁹⁹**
MITMVA670

- Works with a Hand Vacuum Pump
- Helps Remove Trapped Air in the Power Steering System
- Includes: Universal Power Steering Adapter (MVA660), GM Power Steering Adapter (MVA661), Ford Power Steering Adapter (MVA662) Works with a Hand Vacuum Pump Helps Remove Trapped Air in the Power Steering System



For OSB, Call 901-300-4878

Digital Gas Engine Compression Test Kit

SKU **383182** **224⁹⁹**
MITMV5532

- Stores Maximum Compression Value for Up to 12 Cylinders
- 3 Minute Auto Shut-Off
- Sealed, Grease and Oil-Resistant Gauge Face Prevents Contamination of Electronics
- Displays Values in psi, Bar and kPa



Diesel Digital Compression Test Kit

SKU **988885** **399⁹⁹**
MITMV5535

- Features an Electronic Tester that Memorizes Peak Values for Each Cylinder Injector Adapter
- Includes: (2) Injector Adapters and (4) Glow Plug Adapters for Testing Most Modern Diesel Cars and Light Trucks Sold in the U.S.



Ford 6 Liter Adapter

SKU **972279** **54⁹⁹**
MITMVA5610

- Glow Plug Adapter - M14 x 1.25
- International VT365
- Ford Power Stroke, 6.0 Liter Engine



INNOVA®

OE-LEVEL DIAGNOSTIC TOOLS US-BASED SUPPORT

SDS-Pro

Contact commercial sales manager for pricing.

INNOVA® 7111
SKU#1062521

- Secure Gateway (SGW) access on 2018 & newer FCA vehicles
- Active Tests and Special Functions

- OEM Diagnostics
- Removeable VCI - Wireless Diagnostics
- FREE access to RepairSolutions PRO built-in



POWERED BY
REPAIR SOLUTIONS PRO

SDS-Tech

Contact commercial sales manager for pricing.

INNOVA® SDS50
SKU#1269649

- OEM Diagnostics
- Active Tests and Special Functions for ECM/PCM, TCM

- Reads TPMS/Tire Pressure
- Service Check and Warning Light
- FREE access to RepairSolutionsPRO



POWERED BY
REPAIR SOLUTIONS PRO

SDS-Inspector

Contact commercial sales manager for pricing.

INNOVA® SDS43
SKU#1269650

- OEM Diagnostics
- Active Tests and Special Functions for ECM/PCM, TCM

- Reads Tire Pressure, Service Check and Warning Light
- Multiple Report Types
- FREE access to RepairSolutionsPRO



POWERED BY
REPAIR SOLUTIONS PRO

INNOVA® AUTOMOTIVE DIGITAL MULTIMETER

3340
SKU#94874

- Tests alternators, diodes, solenoids, breaker points, wiring, switches and more
- 10 MegOhm impedance prevents damage to ECU
- Measure RPM, Dwell, Frequency, Temperature, Pulse Width, Duty Cycle
- Accessories included



POWERED BY

REPAIR SOLUTIONS PRO

Download on the App Store

GET IT ON Google Play

Designed for professional technicians to simplify and augment their vehicle diagnostic process.

- Verified Fixes
- Repair Tips
- Technical Services Bulletins (TSBs)
- Parts/Tools for Repair
- Scheduled Maintenance
- Predicted Repairs



SCAN TO LEARN MORE

PRO-Level OBD Tools

INNOVA® AUDIO ENHANCED INSPECTION CAMERA

3381
SKU#1392578

- Record video and audio
- 8 Bright Illumination LEDs fully light up the inspection area
- IP67 Rated Submersible Lens allows safe inspection of areas contaminated by oil or water

Accessories Included:
Magnet, Hook and Mirror

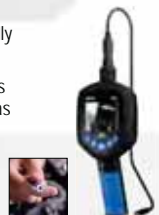

GREASE GUNS

TO ORDER, contact your Commercial Sales Manager or go to AutoZonePro.com

GREASE GUNS

Grease Guns

- Cast Iron Pump Head for Added Strength and Durability
- Multiple Filling Options to Support Suction, Filler and Cartridge Loading

- Precision Fit Plunger Prevents Grease Bypass and Resists Scoring
- Heavy Duty Follower Spring Allows Easy Priming and Efficient Pumping



87206

Mini Lever Action



87204

Lever Action Clear

Clear Barrel for Easy Grease Monitoring



87201

Lever Action



87203

Pistol Grip with 18" Extension Hose



87205

Pneumatic with 18" Extension Hose

SKU 1207896 87206	SKU 1207899 87204	SKU 1362012 87201	SKU 1207888 87203	SKU 1207901 87205
• 4,000 Max. psi	• Includes 7" Extension • 10,000 Max. psi	• Includes: 6" Steel Extension • 7,000 Max. psi	• Pistol Grip Handles Supports One Handed Operation • 6,000 Max. psi	• Includes 5.5" Extension • Air Operated for Continuous Lubrication Flow • 6,000 Max. psi
19⁹⁹	39⁹⁹	39⁹⁹	29⁹⁹ REG. \$39.99 Offer Good Through December 31, 2025 SAVE \$10	39⁹⁹ REG. \$69.99 Offer Good Through December 31, 2025 SAVE \$30

Grease Gun Accessories

7 Piece Grease Gun Accessory Kit

SKU 978118 **44⁹⁹** **SAVE \$20**
25711 REG. \$64.99

- Includes: Press-On 90° Lube Tool, Straight Extension, 300 mm Hose Extension, Slide-On 90° Coupler, Rubber Tip Nozzle, Needle Nozzle and 60° Coupler



Offer Good Through December 31, 2025

Extension Hoses with Spring Guard

- Premium Grease Hoses for Manual and Air-Operated Grease Guns
- Spring Guard for Added Rigidity to Prevent Kinking
- Max. Working Pressure: 4,500 psi
- Burst Pressure: 12,000 psi
- Accessory Thread: 1/8" NPT



12" SKU 1207902 **9⁹⁹**
87220

18" SKU 1207887 **9⁹⁹**
87221

36" SKU 1207893 **14⁹⁹**
87222

70 Piece Grease Fitting Assortment

SKU 577685 **25752**
24⁹⁹

- 70 Assorted Grease Fittings in 6 Popular Sizes



Bearing Packer

SKU 1055505 **24⁹⁹**
26540

- Quickly Flushes Out Old Grease and Repacks Bearings with New Grease
- Transparent, Impact Resistant Cup Allows User to Clearly See Grease Level
- Works on Bearings with Up to 3-1/2" Outside Diameter



Universal Bearing Packer

SKU 1339731 **9⁹⁹**
25081

- Connects to Any Grease Gun
- Services Most Roller and Ball Bearings
- Forces Out the Old Grease and Evenly Injects Fresh Grease



Lincoln

20V Li-ion PowerLuber Kit

SKU 751676 **519⁹⁹**
LIN1884

- Delivers Grease at Up to 10,000 psi
- Built-In LED Illuminates the Work Area
- Includes: Grease Gun, 2 Batteries, Charger and Case
- 36" Flex Hose



12V Li-ion PowerLuber Kit

SKU OSB **349⁹⁹**
LIN1264

- Li-ion Battery for Maximum Power and Efficiency
- Delivery at Up to 8,000 psi
- Built-In LED Illuminates Dimly Lit Areas
- 30" Grease Hose



For OSB, Call 901-300-4878

Fully Automatic Pneumatic Grease Gun

SKU 445386 **174⁹⁹**
LIN1162

- Fully Automatic, Continuous Operation
- 30" High-Pressure Hose with Coupler and Attachment Clip
- Pump Ratio: 40:1 at 150 psi
- Max. Grease Pressure: 6,000 psi



Super Pistol Grip

SKU 445385 **89⁹⁹**
LIN1134

- 18" Whip Hose
- Includes Rigid Pipe
- Variable Stroke Design
- 7,500 psi
- Filler Nipple/ Bleeder Valve



Professional Lever Grease Gun with 18" Whip Hose and Coupler

SKU 522903 **54⁹⁹**
LIN1147

- 3-Way Loading: By Cartridge, Bulk Load and Suction Load



Prices subject to change without notice. Prices do not include applicable taxes, vehicles, tires, rims, installation or optional equipment as shown. Please do not return purchases to the store. For information regarding warranty, repair, or any questions or concerns, call 901-300-4878.

FLUID HANDLING

Fluid Extractors

Change fluids quickly and easily anytime. No mess, no clean up.
Simply remove the dipstick and insert the tube.

OEM TOOLS

All OEMTOOLS Fluid Extractors Include:



- Single Piece Reservoir Structure Features a Leak Proof Bottom
- Overflow Shut Off Valve Prevents Fluid from Overflowing
- Use to Extract Most Fluid Types: Engine Oil, Transmission Fluid, Gear Oil, Coolant and Power Steering Fluid
- Updated 41" Extended Dipstick Hose Adapter for Longer Reach and Broader Applications

Manual Fluid Extractors

- Reservoir with Hand Operated Pump to Tackle Big Jobs



2.1 Gallons (8.4 Qts.)
SKU 666877 129⁹⁹
24936

1.4 Gallons (5.6 Qts.)
SKU 544744 99⁹⁹
24389

2.5 Gallons (10 Qts.)
SKU 547010 159⁹⁹
24397

Pneumatic/Manual Fluid Extractors

- Working psi: 85; Max. psi: 120
- Air Consumption: 6.5 CFM



1.5 Gallons (6.3 Qts.)
SKU 666978 109⁹⁹ SAVE \$45
24937 REG. \$154.99

Offer Good Through December 31, 2025

2.5 Gallons (10 Qts.)
SKU 666881 149⁹⁹
24938

Brake Bleeder Adapter Hose for Fluid Evacuators

SKU 568479 19⁹⁹
24446

- Use with OEMTOOLS Fluid Evacuators, Converting Them into One-Person Vacuum Brake or Hydraulic Clutch Bleeders
- Universal Bleed Screw Adapter

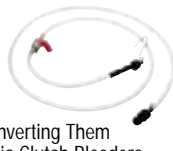

Main Suction Hose Replacement

SKU 1442592 34⁹⁹
24938-1

- Replacement for OEMTOOLS 24938, 24937, 24397, 24389 and 24936



Replacement Dipstick and Tube Adapter

SKU 1442595 24⁹⁹
24938-2

- 1/4" x 17" PVC Hose



Fluid Evacuators

PneumatVac Fluid Evacuator (2.3 Gallon)

SKU 497203 179⁹⁹
MITMV7300

- Operates on Compressed Air
- Independent Air Shut-Off Valve



Fluid Evacuator Plus

SKU 497200 184⁹⁹
MITMV7201

- Evacuates or Dispenses at the Push of a Button
- Integrated 2.3 Gallon (8.8 Liter) Capacity Reservoir
- Durable, Chemical Resistant Polyethylene Construction
- Dipstick Tube Adapters Included



Fluid Evacuator (1.9 Gallon)

SKU 594882 154⁹⁹
MITMV7400

- Integrated 1.9 Gallon (7.3 Liter) Capacity Reservoir
- Evacuates All Kinds of Fluids Including Engine Oil, Transmission Fluids, Gear Oil, Coolant, Brake Fluid and More



Mityvac

Fluid Extractors and Fillers

Mityvac

1.5 L Fluid Extractor/Dispenser

- SKU 606541 89⁹⁹
MITMVA6852
- Simple Manual Syringe-Type Action Quickly and Cleanly Extracts or Dispenses Fluid
 - Integrated Valve and Cap to Prevent Spills and Leaks
 - Compact, Streamlined Design Allows Access into Tight Spaces
 - Ideal for Evacuating or Topping Off Fluid Reservoirs
 - Easy to Clean; Hose and Seals are Simple to Replace



1.5 L Fuel Extraction Syringe

SKU OSB 109⁹⁹
MITMVA6853

- Ideal for Evacuating or Priming Diesel Fuel Systems
- 2 Adapter Hoses: 10 mm Male to 3/8" or 5/16" Female Fuel System Connections
- 3 Male-to-Male Adapters: 10 mm Male to a Barbed, 3/8" or 5/16" Male Connection



For OSB, Call 901-300-4878

Fluid Siphon Pump

SKU 568475 19⁹⁹
24863

- Transfer Fluids Easily Use to Transfer Gas, Water, Oil and Other Non-Corrosive Liquids
- Hose Reach: 6' with 1/2" Diameter



Manual Fluid Extractor and Filler

SKU 1544658 29⁹⁹
25572

- Use to Extract and Refill Many Common Automotive Fluids, Including Brake Fluid
- Dual Scale Molded into Cylinder Body (Qt/mL)
- Translucent Cylinder Body to Easily Read Volume Extracted and Fluid Condition
- 500 cc Volume & Suction Tubes Enable Faster, More Efficient Fluid Transfer
- Great for Oil, Transmission Fluid, Power Steering Fluid, Brake Fluid, and More



OEM TOOLS

Transmission Fluid Fill Adapter

SKU 1125880 19⁹⁹
25740

- Required Tool to Fill or Add Fluid to the 5R55W Automatic Transmission
- Used in Many Ford Vehicles (2003 - Newer) Same as Ford No. 307-437

OEM TOOLS



Fluid Management

OEM TOOLS®

Manual ATF Filler System

SKU **526508** **164⁹⁹**
24441

- Complete System for Servicing Sealed Automatic Transmissions
- Includes Adapters to Fit Ford, BMW, Honda, Nissan, VW, Porsche, Mini Cooper, Audi and Mercedes-Benz Transmissions
- Reservoir Capacity: 3 Liters (3.1 Quarts)
- Fluid Dispensing Hose Features a Swivel Connector and Fluid Dispensing Shut-Off Valve
- Comes with Belt Attachment for Storing All of the Adapters on Dispenser
- Adapters Included:
DSG M24 x 1.5,
CVT M22 x 1.5,
CVT M12 x 1.5,
ATF M10 x 1.0,
ATF 1/8 NPT - 27,
ATF 04, ATF 03
and ATF 02



ATF Refill Kit, 5 L

SKU **265092** **484⁹⁹**
MITMV6410A

- Fluid is Dispensed Under Pressure for Smooth Continual Flow
- Integrated Manual Pump Adds Air Above the Fluid Level to Prevent Aeration
- Internal Pump Components are Sealed Against Exposure to Fluids
- Flow Control Valve is Conveniently Located Near Fluid Output
- Features Integrated Safety and Manual Pressure Relief Valve



Pneumatic ATF Refill Kit, 10 L

SKU **1330680** **524⁹⁹**
MITMV7412

- Utilizes Compressed "Shop-Air" to Produce Pressure for Fluid Dispensing



ATF Refill Adapters with Hose

SKU **1361999** **264⁹⁹**
MITMV7216A

Quickly Converts the Mityvac MITMV7201 Fluid Evacuator Plus into a Professional Tool for Refilling Sealed Automatic Transmissions

- 13 Quick-Change ATF Refill Adapters Fit Most Vehicle Transmissions



Gear Oil Dispenser Bottle and Tubing Kit

SKU **1544678** **229⁹⁹**
MITMVA577

- 10 Liter Gear Oil Dispense Bottle with Low Restriction Hose, Valve and Nozzle
- Bottle and Dispensing Equipment Included with Most Automotive Fluids (Except DEF)
- Fluid Level Indications on Reservoir to Monitor Fluid Levels
- Compatible with MV7100 and MV6400 Lids
- 10 Liter Reservoir for Larger Dispensing/Longer Refill Intervals
- Compressed Air Moves Fluids-Reduces Risk of Contamination



Pneumatic Powered Gear Oil Dispenser

SKU **1544685** **439⁹⁹**
MITMV7454

- 10 Liter Pneumatic Pump Gear Oil Dispense Bottle with Low Restriction Hose, Valve and Nozzle
- Powered by Compressed Air
- 10 Liter Reservoir for Larger Dispensing/Longer Refill Intervals
- Can be Pressurized and Disconnected from Compressed Air Source for Convenience
- Easily Replaceable Tubing for Repair or Customization of Unit to Job Requirements



Hand Pump Powered Gear Oil Dispenser

SKU **1544672** **329⁹⁹**
MITMV7455

- 10 Liter Hand Pump Gear Oil Dispense Bottle with Low Restriction Hose, Valve and Nozzle
- 10 Liter Reservoir for Larger Dispensing/Longer Refill Intervals
- Hand Pump Supplies Compressed Air to Power Unit
- Manual Pump to Compress Air; Nothing but Pressurized Air Moves Fluid which Lessens Risk of Contamination
- Fluid Level Indications on Reservoir to Monitor Fluid Levels



Universal Fluid Dispensing System

SKU **265093** **254⁹⁹**
MITMV6400

- Large 1.2 Gallon (5 Liter) Fluid Capacity
- Integrated Manual Pump Adds Air Above the Fluid Level to Prevent Aeration
- Pressure Gauge Indicates Fluid Dispensing Pressure
- Safety and Manual Pressure Relief Valve
- Vehicle Adapters Not Included



Dispensing Hose Assembly

SKU **1544679** **64⁹⁹**
MITMVA595

- Replacement Hose for MITMV7454, MITMV7455 and MITMVA577



Great for Use with Generators

OEM TOOLS®

Battery-Operated Liquid Transfer Pump

SKU **1414413** **14⁹⁹**
87230

- Move Liquids Safely and Easily with this Convenient Handheld Pump
- Use in Garage, Aquariums, Home and Yard
- Pumps Up to 6 Quarts of Liquid per Minute
- Battery Operated (2 "D" Batteries)



FLUID HANDLING

Lever Action Pumps

OEM TOOLS

Lever Action Hand Oil Pump
SKU 462495 24381 **44⁹⁹**

- Oil Pump for Use with Oil-Based Fluids, Heating Oils, Motor Oils, Heavy and Light Oils, Diesel and Kerosene
- Built-In 1-1/2" and 2" Bung for Use on 16 to 55 Gallon Drums with Either Opening
- Not for Gasoline or DEF



OEM TOOLS

Lever Action Barrel Pump - Polypropylene
SKU 688036 24471 **54⁹⁹**

- Lever Action Pump, Self-Priming
- Ideal for Diesel, Kerosene, Lubricants and Other Oils
- Not for Gasoline, Water Based Chemicals or DEF
- Maximum Flow Rate: 12 Oz. per Stroke
- Maximum Viscosity: 40 Wt. Oil



OEM TOOLS

Lever Action Barrel Pump Polypropylene Stainless Steel Rod
SKU 688038 24472 **54⁹⁹**

- Ideal for Pumping Diesel, Oils, Kerosene, Water-Based Chemicals, Bases and Mild Acids
- Not for Gasoline or DEF



OEM TOOLS

Lever Action Barrel Pump - Ryton® Stainless Steel Rod
SKU 688037 24473 **84⁹⁹**

- Ideal for Pumping Diesel, Oils, Kerosene, Water-Based Chemicals, Bases and Acids Including DEF
- Not for Gasoline

DEF COMPATIBLE



LINCOLN

Lever Action Barrel Pump
SKU 970530 LIN1340 **99⁹⁹**

- Pumps Non-Corrosive Fluids, Not for Gasoline
- Telescoping Tube for 16 to 55 Gallon Drums
- Removable Non-Drip Spout Allows for Threaded Hose Connection



Rotary Pumps

OEM TOOLS

Rotary Barrel Pump
SKU 462486 24382 **54⁹⁹**

- Fluid Transfer Pump for Use with Oil-Based Fluids, Heating Oils, Motor Oils, ATF, Diesel and Kerosene
- Not for Gasoline or DEF



OEM TOOLS

Polypropylene Rotary Drum Pump
SKU 688035 24470 **129⁹⁹**

- Ideal for Pumping Diesel, Oils, Kerosene, Water-Based Chemicals, Bases and Mild Acids
- Not for Gasoline or DEF



LINCOLN

Manual Rotary Oil Pump with Hose for 55 Gallon Drums
SKU 265089 LIN1385H **349⁹⁹**

- Includes: 8 Ft. x 3/4" Anti-Static Hose with Non-Sparking Aluminum Nozzle with Hanger; Seal Tight Telescoping Pick-Up Tube with Strainer for 16 to 55 Gallon Drums with 2" Bung



Manual Rotary Pump for 55 Gallon Drums
SKU 462977 LIN1385 **264⁹⁹**

- Hose Not Included

Drum Not Included

LINCOLN

Manual Rotary Fuel Pump with Hose for 55 Gallon Drums
SKU 265088 LIN1387 **389⁹⁹**

- 3 Vane Manual Rotary Pump for Most Fluid Types Including Gasoline, Diesel, Kerosene, Coolant, Non-Corrosive Materials, Medium Viscosity Petroleum Based Fluids, Hydraulic Oils and ATF



Drum Not Included

Drum Wrench

OEM TOOLS

Aluminum Drum Bung Wrench
SKU 1267963 22664 **24⁹⁹**

- Comfortable and Textured Grip for Ease of Use
- Non-Sparking, Non-Corrosive Aluminum Construction
- Fits Most Steel and Plastic Caps, Including 3/4" Vent Plugs
- Effortlessly Opens and Tightens Bungs to Guarantee Drum Contents are Safe
- Opens 10, 15, 20, 30 and 55 Gallon Barrels



Fuel Transfer Pump

JohnDow Industries

25 Gallon Steel Gas Caddy
SKU 360585 DOWFC25GC **749⁹⁹**

- UL Approved
- 25 Gallon Tank is Constructed of 14" Gauge Steel for Use with Unleaded Gasoline, Kerosene, Ethanol E85, Diesel and Bio-Diesel Fuels



DEF Pump

LINCOLN

Lift Action Pump
SKU 1142361 LIN1390 **169⁹⁹**

- Transfers Popular Shop Fluids Including Acetone, Antifreeze, Windshield Washer, Thinners and More
- Includes NPT and Buttress Threads for Steel and Plastic Drums
- Adjustable Bung Type Fits 15, 16, 30 and 55-Gallon Drums
- Welded Ground-Post for Safe Dispensing of Volatile Fluids
- Premium Grade 316 Stainless Steel
- Self-Priming

DEF COMPATIBLE

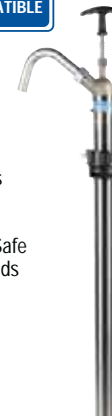

Grease Pump

LINCOLN

Manual Gear Lube Dispenser
SKU 174166 LIN1293 **154⁹⁹**

- 5' Hose, 13" Pump Tube
- Fits 25 to 50 Lb. 5 Gallon Containers
- Delivers 1 Oz. per Stroke



FLUID HANDLING

TO ORDER, contact your Commercial Sales Manager or go to AutoZonePro.com

FLUID HANDLING

Fluid Exchangers

MAHLE

ATX280 Trans Fluid Exchange Unit
SKU OSB
MSS4008002300 **5,799⁹⁹**

- 7" Touchscreen LCD Display with Graphical Interface
- Onboard Additive Tank for Detergent/Oil Injection



Fluid Not Included

Trans-Tech 4 Plus
SKU OSB
MVC500-1125B **5,699⁹⁹**

- Automatic, In-Line Exchange Through Vehicle Cooler Line
- ATF Exchange Through Vehicle Transmission Dipstick
- Drain Pan Feature
- 26 Quart New Fluid Reservoir
- High Volume Pump for Rapid and Efficient Service
- Comes with Standard Set of Adapters
- Uses MVC400-0137 2-Part ATF Cleaner and Conditioner Fluid

MOTORVAC



Fluid Not Included

BFX-10 Brake Fluid Exchanger

MAHLE

SKU OSB
MSS4258001600 **1,249⁹⁹**

- Suitable for ABS, ESP, EDS and SBC
- Hydraulic Pump
- Two Universal Adapters Included



Fluid Not Included

BFX-20 Brake Fluid Exchanger

MAHLE

SKU OSB
MSS4258001400 **2,449⁹⁹**

- Hydraulic Pump
- Suitable for ABS, ESP, EDS and SBC
- Adapters Included



Fluid Not Included

Lube Tech Set

OEM TOOLS

SKU 227302 | 24965

1,899⁹⁹ REG. \$2,252.39

Includes 160 of the Most Common Tools in Tool Cart

- SAE and Metric, 1/4", 3/8" Drive Tools, Combination Wrench Sets, Pliers and Screwdrivers. Plus Battery Service Tools, Oil Change Tools and More

SAVE **\$352**



Go to AZTOOL1.com for 24965 Contents List



Cart Style and Color May Vary

Offer Good Through December 31, 2025

To Confirm Price, Availability and Ordering Instructions on OSB Call 901-300-4878

Oil and Grease

Lynx 3:1 Universal Stub Pump

SKU 1580956
BAL1110-007 **424⁹⁹**

- Reliable Air Motor Design that Features Corrosion Resistant Materials
- Double-Acting Pump Design for Smooth and Accurate Fluid Delivery
- Includes: 2" Bung-Adapter



Oil Control Handle with Digital Meter

SKU 1485049
BAL3330-159 **324⁹⁹**

- Exclusive "Memory" Flex Enables the Extension to Bend Into Any Desired Shape
- Replaceable Electronic Circuit Board and Face Plate
- Ergonomically Designed Grip Handle Reduces Fatigue for Technicians



Balerank
Fluid Dispensing Systems

Electronic Preset Meter

SKU OSB
BAL3331-032 **649⁹⁹**

Tank Package

SKU OSB
BAL1135-017 **3,999⁹⁹**

- 50' EVO Reel
- Lynx 5:1 HD Pump
- 275 Gal Double Wall Construction
- UL 2258 Certified
- Compatible Fluids: DEF, Diesel and Lubricants
- Package Assembled from Factory



5:1 HD Oil Pump Drum Package

SKU OSB
BAL1131-069 **2,299⁹⁹**

- Reliable Air Motor Design that Features Corrosion Resistant Materials
- Includes: Heavy-Duty Drum Cart with Semi-Pneumatic 10" Tires, Front Caster with Brake to Steady Cart While in Use, 50' x 1/2" Hose Reel and Electronic Metered Handle



Drum Not Included

Lynx 55:1 Pump Package

SKU OSB
BAL1151-036 **1,274⁹⁹**

- Reliable Air Motor Design that Features Corrosion Resistant Materials
- Double-Acting Pump Design
- Optional Hose Reel Mounting Kit

Lynx 55:1 Portable Grease 120 lb Package

SKU OSB
BAL1151-028 **874⁹⁹**



Drum Not Included

Inside View

Prices subject to change without notice. Prices do not include applicable taxes, vehicles, tires, rims, installation or optional equipment as shown. Please do not return purchases to the store. For information regarding warranty, repair, or any questions or concerns, call 901-300-4878.

AZG0425

OIL CHANGE

Oil Drains



18 Gallon Rolling Oil Drain
 SKU **988882** **389⁹⁹**
 LIN3601

- All Steel Design Includes Reinforced Caster Supports
- 14" Telescoping Bowl: Range of 45" to 72"
- Preset Air Regulator (Up to 150 psi)
- Pressurized Self-Evacuation Feature Requires Only Shop Air and a Tire Chuck to Discharge Fluids



25 Gallon Used Fluid Combo Drain/Evacuator
 SKU **543345** **834⁹⁹**
 LIN3639

- Powerful Compressed Air Operated Venturi Vacuum Quickly Draws Fluids from Reservoirs
- Includes: Mercedes-Benz, BMW and VW Dipstick Tube Adapters and 6 Evacuation Wands of Varying Flexibility, Diameter and Length
- Pressurized Self-Evacuation Feature Requires Only Shop Air and a Tire Chuck to Discharge Fluids
- Min. Height: 60"
- Max. Height: 74"



25 Gallon Used Fluid Evacuator
 SKU **543344** **639⁹⁹**
 LIN3637

25 Gallon Used Fluid Gravity Drain
 SKU **543350** **764⁹⁹**
 LIN3635



18 Gallon Rolling Oil Drain
 SKU **667005** **349⁹⁹**
 87042

- Pressurized Self-Evacuation Feature Requires Only Shop Air
- Funnel Capacity: 2.6 Gallons
- Funnel Diameter: 17"
- Min. Height: 44.5"
- Max. Height: 68.5"



21 Gallon Oil Drain Vacuum and Extractor
 SKU **546658** **899⁹⁹**
 24862

- Designed for the Collection of Used Fluids from Lift Mounted Vehicles or by Evacuation Directly from Fluid Reservoirs or Dipstick Tubes
- Funnel Diameter: 15"
- Funnel Extension Adapter: 22"
- Funnel Height Adjustment: 45" to 62"
- Includes 5 Extraction Tubes: 7 mm x 35"; 6 mm x 29"; 6 mm x 23"; 6 mm x 22" and 3/8" x 15"



9 Gallon Upright Portable Oil Drain
 SKU **908386** **149⁹⁹**
 87032

- Adjustable Drain Height: 32" to 62"
- Funnel Diameter: 17"
- Features Built-In Drain Valve and Evacuation Spout
- 4 Heavy Duty Casters for Easy Transport
- Includes: Tool Holder



Tool Tray



Easily Pour Out Used Oil



18 Gallon Upright Portable Oil Drain
 SKU **908388** **199⁹⁹**
 87031

- Adjustable Drain Height: 54" to 70"
- Funnel Diameter: 18"
- Features Built-In Drain Valve and Evacuation Spout
- 4 Heavy Duty Casters for Easy Transport
- Includes: Tool Holder



Tool Tray



Drain Valve



21 Gallon Waste Oil Drain
 SKU **544817** **449⁹⁹**
 24861

- Pressurized Self-Evacuation Feature Requires Only Shop Air
- Large Diameter Funnel Includes a Removable Filter Screen and Wide-Mouth Extension
- Funnel Diameter: 15"
- Funnel Extension Diameter: 22"
- Funnel Height Adjustment: 45" to 62"



Large Funnel

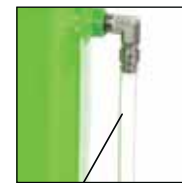

Sight Tube Catches Fluids without Spills



OIL CHANGE

TO ORDER, contact your Commercial Sales Manager or go to AutoZonePro.com

OIL CHANGE

Used Fluid Drains



23 Gallon Anti-Freeze Drain

SKU **1485042** **874⁹⁹**
BAL4110-025

- Powder-Coated Green
- 3/4" Cam-Lock Fitting



- All-Steel Tank and Base
- Easy-to-Use Patented Cantilever Mechanism

Premium Drains Capture Used Fluids and Transfer Them to Any Bulk Storage Tank Using a Cam-Lock Kit and Evacuation System

23 Gallon Oil Drain

SKU **1485039** **874⁹⁹**
BAL4110-024

- Powder-Coated Black
- 1" Cam-Lock Fitting



Oil Change Kit



Oil Change Lube Tech Kit

SKU **1169108** | **68916**

- Includes: Oil Filter Wrench Pliers, Oil and Transmission Funnel, 3-Legged Oil Filter Wrench, 10L Oil Jug, Drain Plug Socket Set, Professional Swivel Oil Filter Wrench Kit (Fits Sizes 2-3/8" to 4-3/8"), Safety Glasses, 18 Gallon Upright Portable Oil Drain and 10 Piece Metric Cap Wrench Set



18 Gallon Oil Drain



279⁹⁹

REG. \$408.91

SAVE **\$128**
OVER
When You Buy the Kit

Accessories

Prevents Splashing of Hot Oil



Oil Drain Splash Pads

- Keeps Work Areas Clean While Changing Transmission or Other Oils
- Allows Hot Oil to Drain Through Porous Pad

15" Round

SKU **1340218**
SHA73850

19⁹⁹



22" Square

SKU **1340219**
SHA73851

24⁹⁹



Drains Not Included. Not for Coolants or Fluids That Will Be Recycled in the Vehicle

Super Transmission Drain Funnel



SKU **291377** **84⁹⁹**
LIS17902

- Extends the Catch Area of Any Lift Drain
- Fits the Ford E 40D
- Dimensions: 24" x 36"



Transmission Drain Pan



SKU **908383** **39⁹⁹**
87035

- Flexible Plastic Construction Fits on Top of Funnels for Most Lift Drains
- Built-In Screen to Catch Debris, Parts and Tools
- Dimensions: 22-3/4" (L) x 23-3/4" (W) x 4-3/4" (H)



Filter Crusher



Industrial 10 Ton Oil Filter/Can Crusher

SKU **OSB** **2,449⁹⁹**
RANRP20FC

- Reduces Used Oil Filters to 1/4 of the Original Size
- 20,000 Lb. Crushing Power
- 100% Air Operated for Minimal Maintenance
- Save on Disposal Costs and Storage Space
- Automatic Safety Door Stops Operation When Opened
- Pressure Regulator and Air Moisture Separator Come Standard
- Transparent Door for a Convenient View of the Crushing Process
- Welded Steel Plate Construction
- Exclusive X-Shape Bevel in Press Head Pre-Aligns Filters for Absolute Vertical Press

INCLUDES
STAND



For OSB, Call 901-300-4878

Used Oil Evacuation



- Includes All Necessary Fitting, Brackets, Valves, Hoses and Components for Seamless Integration with Air System and Fluid Collection/Discharge Processes

Evacuation Package for Used Antifreeze

SKU **1485050** **1,774⁹⁹**
BAL1121-025

1" Evacuation Package for Used Oil

SKU **1485032** **1,799⁹⁹**
BAL1121-024



Prices subject to change without notice. Prices do not include applicable taxes, vehicles, tires, rims, installation or optional equipment as shown. Please do not return purchases to the store. For information regarding warranty, repair, or any questions or concerns, call 901-300-4878.

AZG0425

35

OIL CHANGE

Oil Filter Tools

Filter Removal Cup

- Specifications: 6" x 6" x 6" (34 Oz. or 1 Liter), Volume Sufficient to Hold Typical Size Filters Commonly Used on Cars, SUVs, Light Duty Trucks and Vans
- Safely Holds Oils, Fuel (Gasoline, Diesel, Biofuels), Brake Fluid, Antifreeze and Other Hazardous Fluids, (Not Intended for Storing Fluids)



1 Pack
SKU 1089033
SURFC5 **29⁹⁹**



2 Pack
SKU 1245617
SURFC5PK2

39⁹⁹

REG. \$59.98

SAVE OVER **\$19**

When You Buy the 2 Pack

Torque Limiting Adapter for Oil Filter Canister Caps

SKU 1580932 **29⁹⁹**
87118



- 3/8" Drive Adapter Limits Torque to 25 Nm
- Prevents Over Tightening and Damage to Plastic and Metal Oil Filter Caps
- Can Also Be Used with a 21mm Socket or Wrench for Limited Access Areas



NEW

Swivel Oil Filter Wrench

SKU 1125870 **9⁹⁹**
87115



- Fits Oil Filters 4-3/4" to 5-3/4"
- 1" Wide Stainless Steel Band



Auto Fit Filter Pliers

SKU 1339727 **14⁹⁹**
87164



- Suitable for Filters with 2.4" to 5" Diameters
- Long Reach Slip Joint Design
- Precision Machined Jaw
- Non-Slip Comfort Grip



3 Jaw Adjustable Magnetic Oil Filter Wrench

SKU 908387 **14⁹⁹**
25101



- Oil Filter Diameter: 2.4" to 3.6" (60 mm to 93 mm)
- Secure Magnetic Attachment
- Spring-Loaded Legs for a Secure Grip
- Includes 3/8" to 1/2" Drive Adapter



3 Jaw Adjustable Filter Wrench

SKU 1339734 **19⁹⁹**
87160



- Works on a Variety of Vehicles
- Fits Oil Filters 2-1/2" to 4-1/2" (63.5 mm to 114 mm)
- Fits 3/8" Drive Ratchets and Extensions
- Perfect for Removing Hard to Reach Filters



4 Piece Swivel Oil Filter Wrench Set

SKU 1414418 **39⁹⁹**
87117



- Fits Oil Filters 2-3/8" to 2-7/8", 2-7/8" to 3-3/8", 3-3/8" to 3-3/4" and 3-3/4" to 4-3/8"
- Dimpled Band with 3 Sets of Grippers to Hold Filter Securely in Place
- 1" Wide Stainless Steel Band for a Strong Grip and Slip Resistance
- Rubber Cushioned TPR Grip for Comfort and Safety in Tight Places
- Includes OEMTOOLS 87111, 87112, 87113 and 87114



4-in-1 Steel Oil Filter Wrench

SKU 1189097 **9⁹⁹**
87116

4 Interchangeable Swivel Bands

- Size Range 2-3/8" to 4-3/8" (60.3 mm to 111.1 mm)
- 1 Swivel Handle with 4 Stainless Steel Bands
- Bands are Easily Removed and Installed



2 Detent Pins Help Quickly Remove and Install Bands



180° Swivel Joint Reaches Impossible Places



2-3/8" to 5" Oil Filter Pliers

SKU 757057 **24⁹⁹**
25324

- Removes Stubborn Oil Filters from Gas or Diesel Engines
- Long Reach Slip Joint Design
- Precision-Machined Jaw
- Non-Slip Comfort Grip
- 14" Length

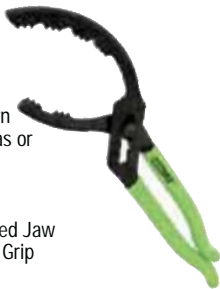

2-1/2" to 4-5/8" Oil Filter Pliers

SKU 141500 **14⁹⁹**
25320

- 20° Jaw Bend for More Applications
- Jaw Teeth for Sure Grip
- 12" Length



Heavy Duty Oil Filter Strap Wrench

SKU 1544663 **24⁹⁹**
87119



- For Use with 3/8" or 1/2" Drive Tools
- Fits Oil Filters Over 8" in Diameter
- Heavy Duty 27" Nylon Strap



15" Chain Wrench

SKU 452624 **39⁹⁹**
22659



REG. 64.99

- Great for Stubborn Oil Filters
- Designed for Tight Spaces
- Double-Action Allows Use in Either Direction
- Capacity: 5-1/2" Diameter
- 15" I-Beam Handle



SAVE **\$25**

Offer Good Through December 31, 2025

Heavy Duty Truck Oil Filters

- Extra Wide Band for Secure Grip
- 1/2" Drive Tools



SKU	Part #	Range	Reg.	Price	Savings
344322	25231	4-1/8" to 4-5/8" (104 to 118 mm)	34.99	19.99	\$15
344323	25232	4-5/8" to 5-1/4" (118 to 134 mm)	34.99	19.99	\$15
344324	25233	5-1/4" to 5-3/4" (134 to 142 mm)	29.99	-	-

Offers Good Through December 31, 2025

Oil Filter Plug for Cummins

SKU 1340221 **14⁹⁹**
87168



- Perfect Tool for Installing and Removing Oil Filters
- Compatible with Dodge 6.7 Diesel Engines
- Prevents Oil Leaks When Removing Oil Filters from Engines
- Hard Plastic Construction for Maximum Strength and Durability
- Wide U-Shaped Handle for Added Grip and Control



Cap Style Filter Wrenches

Toyota/Lexus Oil Filter Cap Wrench Set

SKU **383457** **24⁹⁹**
25409

- Sizes: 64 mm, 73 mm and 74 mm
- Comes in Sturdy Blow Mold Case



9 Piece Oil Filter Cap Wrench Set

SKU **255627** **149⁹⁹**
27199

- Includes: 5 Chrome Plated Aluminum Wrenches (64.5 mm - 14 Flute Toyota, 64.5 mm - 14 Flute Toyota/Lexus, 88.8 mm - 15 Flute Hyundai/Kia, 74.2 mm - 14 Flute European, 86.6 mm - 6 Flute European), (1) 63 mm to 83 mm Adjustable Filter Wrench for Universal Applications, 3 Forged Low Profile Oil Filter Sockets (27 mm, 32 mm and 36 mm) and 3/8" Drive Application Chart for Quick Reference
- Comes in Sturdy Blow Mold Case



10 Piece Metric Cap Wrench Set

SKU **1189096** **34⁹⁹** REG. \$44.99 **SAVE \$10**
87151

- Painted for Rust Resistance
 - Includes: 65/67 mm - 14 Flutes, 80 mm - 15 Flutes, 68 mm - 14 Flutes, 86 mm - 16 Flutes, 74/76 mm - 15 Flutes, 93 mm - 15 Flutes, 76 mm - 14 Flutes, 93 mm - 36 Flutes, 76 mm - 30 Flutes, 100 mm - 15 Flutes
 - Comes in Sturdy, Green Blow Mold Case
- Offer Good Through December 31, 2025



OEM TOOLS

Make	SKU	Part #	Size	Price	
BMW/Volvo	255675	25453	86.6 mm - 16 Flutes	19.99	
Hyundai/Kia	255659	25454	88.8 mm - 15 Flutes	24.99	
Toyota/Lexus	255634	25451	64.5 mm - 14 Flutes	14.99	
Toyota/Lexus	1340227	87131	64.5 mm - 14 Flutes	9.99	
Mercedes-Benz Sprinter/VW/Audi Porsche/Mazda	1340230	87132	74.2 mm - 14 Flutes	9.99	
Mazda/Ford	1340228	87133	75.6 mm - 14 Flutes	4.99	
Chrysler	1340234	87134	84 mm - 14 Flutes	19.99	
Volvo	1340237	87136	88.8 mm - 15 Flutes	19.99	
Land Rover	1340238	87137	90 mm - 15 Flutes	24.99	

Drain Plug Tools

OEM TOOLS

14 Piece Drain Plug Socket Set

SKU **818568** **34⁹⁹**
25374

- Designed for Both Foreign and Domestic Vehicles Including: BMW, Ford, Mazda, Mercedes-Benz, Nissan, Peugeot, Renault and More
- Ideal for Removal of Oil Drain Plugs from Manual Transmissions, Transfer Cases, Differential Housings and More
- Includes Hex: 9, 10, 12, 14 and 17 mm; Square: 7, 8, 11, 13 mm, 5/16", 3/8"; Female Square: 10 mm; Male Triangle: 10 mm; Tamper-Proof Triple Square: 16 mm

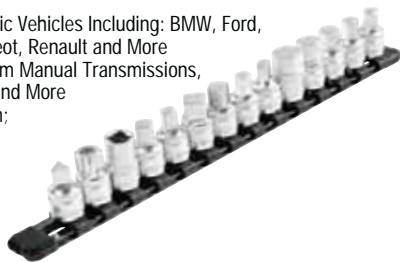

8-in-1 Oil and Lube Multi-Wrench

- Designed to Fit Most Oil Drains, Transfer Case and Differential Plugs
- Features Offset Head Design with Yoke Support for High Torque Applications



SKU **1442594** **49⁹⁹**
CTA2495K

- 6 Point Metric
- Sizes: 12, 13, 14, 15, 16, 17, 18 and 19 mm



SKU **1442585** **47⁹⁹**
CTA2497K

- Male Square and Hex
- Square: 8 mm, 10 mm, 3/8" and 1/2"
- Hex: 10, 12, 14 and 17 mm



3 Piece Plastic Oil Drain Plug Removal Set

SKU **1207894** **14⁹⁹**
25098

- Safely and Easily Removes Plastic Oil Drain Plugs on Late Model Ford, Volkswagen, BMW and Audi Cars
- 3/8" Drive
- Does Not Cause Damage to the Plug

OEM TOOLS



Oil Filter Sockets

7 Piece Oil Filter Removal Socket Set

SKU **191682** **39⁹⁹**
27197

- 3/8" Drive
- Includes: 24 mm for Cadillac; 27 and 36 mm for Mercedes-Benz, VW, Cadillac, Buick, Saturn, SAAB; 29 mm for Dodge Cummins Fuel Filter; 30 mm for Korean Cars; 32 mm for GM, Saturn and SAAB; 35/36 mm for Ford Diesel, Mini Cooper, BMW and Mack; 38 mm for Vauxhall Vectra
- Comes in Sturdy, Green Blow Mold Case



7 Piece Offset Oil Filter Cap Wrench Set

SKU **1145990** **29⁹⁹**
87165

- 3/8" Drive Set Includes: 24 mm for Cadillac; 27 and 36 mm for Mercedes-Benz, VW, Cadillac, Buick, Saturn, Saab; 29 mm for Dodge Cummins Fuel Filter; 30 mm for Korean Cars; 32 mm for GM, Saturn and SAAB; 35/36 mm for Ford Diesel, Mini Cooper, BMW and Mack; 38 mm for Vauxhall Vectra
- Comes in Sturdy, Green Blow Mold Case



OEM TOOLS

32 mm Oil Filter Cap Socket

SKU **548385** **9⁹⁹**
25410

- Removes and Installs Oil Filters on 2.2 Liter GM Ecotec Engines Low Profile 1-1/4 In. Socket is Specially Designed for Operating Clearance 3/8" Drive



36 mm Oil Filter Socket for 6.0L Ford Diesel

SKU **110279** **9⁹⁹**
25411

3 Piece Low Profile Oil Filter Socket Set

SKU **094803** **24⁹⁹**
27204

- Includes: 27, 32 and 36 mm
- 3/8" Drive



OIL CHANGE

No Spill Oil Funnels

Universal No-Spill Oil Funnel Set
SKU **1533126** **15⁰⁰**
87025 **NEW**

- Mounts Directly to Vehicle's Oil Fill Port for Spill-Free Oil Changes
- Includes 12 Adapters and 2 Extensions to Cover Most Engine Types
- No-Spill Adapters are Threaded to Securely Fit Filler Necks and Eliminate Oil Spills
- Funnel Can Support an Inverted Quart of Oil
- Transparent Funnel with Embossed Scale Lets You Easily Monitor Fluid Levels



STORE STOCKED

Universal Direct Fit No Spill Oil Funnel Set
SKU **824884** **99⁹⁹**
87039

- Set Includes: Universal Oil Funnel, Chrysler (87019), Ford/Mazda (87020), GM (87021), Honda (87022), Toyota/Lexus (87024), Subaru Adapter, Toyota/Lexus Adapter and 150° Extended Adapter (87027) and Storage Rack
- Funnel Screws Directly into Filler Neck
- Threaded to Fit a Range of Import and Domestic Vehicles Older and Current Models
- Transparent Lower Chamber to Monitor Oil Flow
- Wide Passage for Rapid Refilling



Includes Wall Mount Bracket and Drip Tray



Fast-Clamp Universal Oil Funnel
SKU **825017** **39⁹⁹**
87037

- Automatically Adjusts to Filler Neck
- Securely Clamps into Filler Neck; No Need to Hold Funnel in Place During the Refilling Process
- Transparent Lower Chamber to Monitor Oil Flow
- Clamp Can Be Used with Standard Funnels



STORE STOCKED

Direct Fit Individual Funnels

SKU	Part #	Description	Price
824892	87019	Chrysler, Dodge and Jeep	24.99
824879	87021	GM	19.99
824890	87022	Honda	34.99
824888	87023	Subaru	29.99
824886	87024	Toyota, Lexus, VW and Mercedes	24.99



Dispensers

8 Quart Dispenser Lid and Cap
SKU **080078** **34⁹⁹**
LIS19702

- Spout Cap and Lid to Keep Out Contaminants
- Many Large SUVs and Trucks Now Require More Oil



10 Quart Oil Jug
SKU **605325** **44⁹⁹**
87018

- Safe for Automotive Oils and Fluids
- Convenient Carry and Pour Handles
- Spill Proof Caps



Flexible Spout Measuring Cans

- Designed for One-Hand Operation
- 14" Flexible Spout with Tapered Tip
- Recessed Bottom Drains Fully and Guards Against Punctures
- Rolled-Edge Top Helps Prevent Spilling

5 Quart
SKU **298486** **64⁹⁹**
LING525

8 Quart
SKU **298473** **74⁹⁹**
LING528



Oil Funnels

Oil and Transmission Funnel
SKU **547009** **14⁹⁹**
87008

- Both Straight and 45° Angle Screen to Prevent Trash from Entering Transmission
- Includes Screen and Dust Cap
- Length: 25"



Filter to Keep Transmission Debris Free

Drain Pans

16 Quart Oil Drain Pan

- Heavy Duty Polyethylene Construction
- Features a Pour Spout and No-Splash Lip



Green
SKU **908389** **39⁹⁹**
87034

Black
SKU **908382** **39⁹⁹**
87033

2.8 Quart Low-Profile Oil Drain Pan
SKU **568474** **14⁹⁹**
87017



Great for Motorcycles and Small Engines

4.7 Quart Clear Oil Drain Pan
SKU **568469** **9⁹⁹**
87013

- Built-In Level Scale Lets You See Fluid Level



Great for Transmission Fluid Changes

4.5 Gallon Black Oval Drain Pan
SKU **1142687** **49⁹⁹**
LIS17972

4.5 Gallon Green Oval Drain Pan
SKU **1142342** **49⁹⁹**
LIS17982



Offset Funnel with Spout Cap and Lid
SKU **1544662** **21⁹⁹**
LIS18232

- 10" Tall Translucent Funnel with a 6-3/4" Offset from Center of Mouth to Center of Spout
- Lid and Spout Cap Help Keep Funnel Contaminant Free
- Includes: Offset Funnel with Cap and Lid, Adapter for Transmission and Other Dipstick Tubes



COOLING SYSTEM

TO ORDER, contact your Commercial Sales Manager or go to AutoZonePro.com

COOLING SYSTEM

Pressure Testers

Universal Cooling System Pressure Test Kit

SKU OSB 27068 **99⁹⁹** REG. \$179.99

SAVE \$80

- Quickly and Easily Pressure Test Cooling Systems in Most Vehicles
- Includes 3 Expandable Adapters that Take the Place of Numerous Specialized Adapters
- Easy Lever Style Pressure Relief Valve
- Prevents Damage to Plastic Reservoir Threads that Occurs When the Wrong Adapter is Forced on



For OSB, Call 901-300-4878

Offer Good Through December 31, 2025

Universal Cooling System Adapter Set

SKU 434723 27067 **79⁹⁹** REG. \$99.99

SAVE \$20

- Designed to Fit Most Passenger Vehicles and Light Duty Trucks
- Fits Both Radiators and Plastic Reservoirs
- Universal Design Works with Any Cooling System Pressure Pump
- Prevents Damage to Plastic Reservoir Threads That Occurs When the Wrong Adapter is Forced On
- Pressure Test Pump Not Included



Offer Good Through December 31, 2025

Cooling System Pressure Test Pump

SKU 434722 27069 **119⁹⁹**

- Quickly and Easily Pressure Test Cooling Systems in Most Vehicles
- High Quality Pressure Pump Designed to Work with Most Cooling System Adapters
- Easy-to-Use Lever Style Pressure Relief Valve



Heavy Duty Cooling Test and Refill Kit

SKU 954220 MSC43014 **139⁹⁹**



- Includes: Vacuum Gauge, Sealing Collar, Valve, Rubber Gaskets and Coolant/Draining Hoses
- Sealing Collar (with Rubber Cone) Offers a Wide Variety of Applications for Radiator Filler Necks
- Minimizes the Risk of Engine Overheating
- 2.3 Gallons per Minute Fill Rate



Heavy Duty Cooling Kit

SKU 954231 MSC43306 **529⁹⁹**



- Includes: Heavy Duty Vehicle Adapters, Pressure Test Regulator, Vacuum Refill Attachment with Tubing in a Plastic Case
- For Use with Freightliner, International, Kenworth, Peterbilt, Mack, Volvo, GMC and Sterling Cooling Systems
- Uses Shop Air to Pressure Check and Vacuum Refill
- 4 Quick-Disconnect Vacuum Attachments Provide Quick Refilling of the Cooling System and Eradicates Airlocks



27 Piece Master Radiator Pressure Test Kit

SKU 1053958 MSC43301-A **399⁹⁹**



- Includes: 1 Blue Radiator Cap Test Connector R123/R125, 1 Black Radiator Cap Test Connector R123/R124, 1 Thermometer, 1 Universal Radiator Cap, 1 Vacuum Purge and Refill Tool, Coolant Hose and Additional Installation Accessories, 1 Hand Pump and 19 Adapters (Nos. 2 to 4, 6 to 21) to Fit Most Popular Domestic and Import Cars and Trucks



Cooling System Adapters

Volvo, Saab, Jeep, Maserati, Ferrari

- SKU 133600 27241R **44⁹⁹**
- Fits Maserati and Ferrari Models (2000 - Newer), Jeeps with Male Threads (1990 - 1994), Saab 900 (1978 - 1993), Saab 900 (Drop Top 1994), Saab 9000 (1987 - 1998), Volvos with Male Threaded Necks
 - Diameter: 45 mm
 - Thread Size: 3 mm



Radiator Adapter GM

SKU 133621 27118R **29⁹⁹** REG. \$44.99

SAVE \$15

- Fits Many GM, Chrysler, Ford, Jaguar and Freightliner Models



Offer Good Through December 31, 2025

Audi and VW

SKU 133625 27245R **44⁹⁹**



- Fits Audi A4 (1996 - Newer), A6 (1998 - Newer), A8 (1997 - Newer), S4 (2004 - Newer), TT (2000 - Newer), Bentley (2006 - Newer), Lamborghini (2006 - Newer), Porsche Cayenne (2003 - Newer), Porsche Panamera (2010 - Newer), Volkswagen Passat (1998 - Newer), Beetle (1998 - Newer), Golf and Jetta (1999 - Newer)



Mazda 3, Volvo S40/V50 and Ford

SKU 133633 27249R **49⁹⁹**

- Fits Land Rover LR-2 (2008 - Newer), Mazda 3 (2004 - Newer), Volvo S40 and V50 (2004 - Newer), XC60 (2010 - Newer), Ford Fusion and Escape (2012 - Newer)
- Diameter: 50 mm; Thread Size: 2.5 mm



Toyota, Lexus and Scion Radiator Adapter

SKU 133632 27248R **44⁹⁹**

- Fits Lexus LS (2007 - Newer), Toyota Celica (2000 - Newer), Spyder MR2 (2000 - Newer), RAV4 (2009 - Newer), Prius (2004 and Newer), Camry (2007 - Newer), Highlander (2006 - Newer) and Scion XB (2008 - Newer)
- Diameter: 34 mm; Thread Size: 3 mm



Acura, Chevrolet, Chrysler, Geo, Honda, Isuzu, Lexus, Mazda, Mitsubishi, Suzuki and Toyota

SKU 133624 27244R **29⁹⁹**

- Fits Early Models with 32 mm Opening and a 9 mm Depth



Ford, Jaguar, Pontiac, Range Rover and Saab Radiator Adapter

SKU 133611 27243R **39⁹⁹**

- Fits Jaguar X Type (2002 - Newer), Saab 900 (1994 - 1998), Saab 9-3 and 9-5 (1999 - Newer), Some Saturns and Other Vehicles
- Diameter: 52 mm; Thread Size: 3 mm



VW

SKU 133609 27242R **39⁹⁹**

- Volkswagens with Female Threaded Filler Necks (1990 to 1998)
- Diameter: 57 mm; Thread Size: 3 mm



Ford, Jaguar and Mazda Radiator Adapter

SKU 133631 27247R **44⁹⁹**

- Ford Contour 1998-2000, Jaguar XJ8 1998-Up, Jaguar XK8 1997-2006, Mazda Tribute 2001-Up
- Diameter: 52 mm; Thread Size: 3 mm



Prices subject to change without notice. Prices do not include applicable taxes, vehicles, tires, rims, installation or optional equipment as shown. Please do not return purchases to the store. For information regarding warranty, repair, or any questions or concerns, call 901-300-4878.

COOLING SYSTEM

Coolant Funnels

Professional No-Spill Coolant Funnel Kit

SKU 943142 **39⁹⁹**
87043

- 5 Spring-Loaded Adapters for a Secure Fit
- Simply Select the Correct Adapter, Attach the Funnel and Fill
- Air-Release Tubes to Vent the System During Refilling Process
- Stopper Prevents Dripping When Removing the Funnel
- Includes: Extensions and Adapters for Hard-to-Reach Surge Tanks



OEM TOOLS

Leak Tester

Gas Engine Combustion Leak Tester

SKU 1103608 **34⁹⁹**
37145

- Used to Test for Combustion Leaks That Result from Head Gasket, Cylinder Head and Engine Block Leaks
- Pulls Air from the Cooling System Up Through the Leak Tester; if Carbon Dioxide is Present, the Leak Tester Fluid Color Will Change to Yellow Signifying a Combustion Leak



OEM TOOLS

No-Spill Coolant Filling Funnel Kit

SKU 802197 **19⁹⁹**
87007

- 4 Radiator Cap Adapters to Fit Most Passenger and Light Trucks
- Simply Select Correct Adapter, Thread Together, Attach the Funnel and Fill
- Rotary Switch to Effectively Prevent Drips and Spills, and Stop Overflow and Bubbles
- Includes: 5 Adapters, (2) 45° Elbows and (2) 5" Extension Rods for Difficult-to-Reach Areas



STORE STOCKED

No-Spill Coolant Filling Funnel Kit with Coolant Tester

SKU 1340229 **29⁹⁹**
87045

- Includes 5 Direct Fit Cooling System Adapters to Fit Most Passenger Vehicles and Light Trucks
- Includes: 45° Angled and 5" Extension Adapters for Accessing Hard-to-Reach Spots and Tester for Glycol Based Coolants
- Fluid Stopper to Prevent Drips and Spills When Removing from the Filler Neck



Combustion Leak Detector Fluid (8 Oz.)

SKU 391381 **9⁹⁰**
25739

- Test for Internal Combustion Leaks on Gasoline Engines Fluid Turns Yellow When Exhaust Gases are Present in Cooling System
- Designed for Use with 37145 Combustion Leak Detector (not included)
- Can Be Used with Other Combustion Leak Testers, See Manufacturer's Manual Prior to Use
- Not for Use with Diesel Engines



STORE STOCKED

Radiator Filler

2.4 Gallon Plastic Radiator Filler

SKU 754738 **39⁹⁹**
87104

- Impervious to Oil, Gasoline and Antifreeze
- Stands Up to Extreme Weather



OEM TOOLS

AirEvac Cooling System

AirEvac Cooling System Refiller

SKU 568478 **114⁹⁹**
24444

- Quickly Refills Cooling System and Eliminates Trapped Air
- Helps Prevent Come-Backs and the Threat of Engine Damage
- Universal Adapter Forms an Airtight Seal with Most Radiator and Coolant Bottle Necks
- Performs Vacuum Leak Tests
- Covers Most Radiator and Reservoir Types
- No Custom Adapters Required
- Comes in Sturdy, Green Blow Mold Case



AirEvac Cooling System Kit

SKU 099292 **99⁹⁹**
27066

- Uses Shop Air to Evacuate the Cooling System for Vacuum Leak Testing
- Refills Cooling System without Trapping Air That Causes Overheating
- Universal Adapter Forms an Airtight Seal with Both Radiators and Coolant Reservoirs
- Self-Locking Quick Disconnects for Fast Assembly



OEM TOOLS

Coolant Testing

Professional Series Ethylene Glycol Antifreeze Tester

SKU 750007 **14⁹⁹**
24507

- For Testing Hot or Cold Ethylene Glycol-Based Coolants, Including Dex-Cool®
- Easy-to-Read Discs are Magnified by Convex Design of the Clear, Thermal Resistant Plastic Barrel
- Disc-Type 16-1/4" Tester is Accurate at All Temperatures (Celsius and Fahrenheit Scales)



(Color May Vary)

OEM TOOLS

COOLING SYSTEM

TO ORDER, contact your Commercial Sales Manager or go to AutoZonePro.com

COOLING SYSTEM

Cooling System Tools

4 Piece 14" Jumbo Pick Set

SKU **94658** **39⁹⁹**
25940

- Includes: Straight Pick, 90° Pick, Offset Pick and Hook Pick



OEM TOOLS

Clic-R Hose Clamp Pliers

SKU **1089038** **9⁹⁹**
25102

- Easily Remove or Install Clic-R Type High Tension Clamps
- Heavy Duty and Durable Steel Construction
- Clamps Commonly Found on BMW, Mercedes-Benz, Audi, VW and Other Cars and SUVs



5 Piece Hose Remover Set

SKU **1335785** **19⁹⁹**
26519

- Dual Durometer Handles for Comfort and Grip
- Hooks and Picks are Assembled from Carbon Steel for Strength and Durability
- Perfect for the Removal of Coolant Hoses, Cotter Pins Brake Springs, Large Electrical Connectors and More

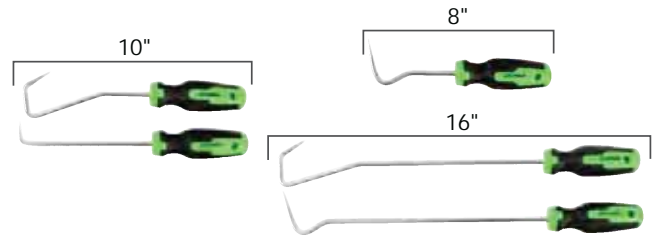

GM Water Pump Socket

SKU **OSB** **29⁹⁹**
27109

- Works on 1993-newer Cadillac Northstar 4.6L V8 Engine (1993-newer) and Oldsmobile Aurora 4.0L L47 V8 (1995-1999) 1/2" Drive
- Black Oxide Finish to Resist Rust
- Chrome Vanadium Steel for Toughness



Hose Clamp Pliers

SKU **607069** **44⁹⁹**
25246

- Removes and Installs Flat Band Spring Style Hose Clamps with Diameters of 1 1/16" to 2-1/2"
- Multi-Position Lock Holds Clamps Open for Hands-Free Operation
- Engineered For Maximum Strength



Master Freeze Plug Installer Kit

SKU **965837** **99⁹⁹**
27208

- Designed to Remove and Install Freeze Plugs Used in Liquid-Cooled Gas and Diesel Engines



Flush Tools

Coolant System Flush Gun

SKU **1284967** **49⁹⁹** **SAVE \$5**
24719 REG. \$54.99

- Universal Nozzle to Fit Various Radiator or Heater Hoses
- Combines Water with Compressed Air to Quickly and Efficiently Flush Cooling Systems
- Comfortable Lever-Action Air Throttle with Lock-On Latch for Simple Attachment of Air Hoses
- Used for the Detailed Flushing of Debris and Contaminants from the Cooling System During Repair and Maintenance



Offer Good Through December 31, 2025

OEM TOOLS

Heater Core Backflush Tool

SKU **511000** **29⁹⁹**
THX356

- Fits 1/2", 5/8" and 3/4" Heater Hoses
- Saves Costly Replacement of Most Stubbornly Clogged Heater Cores



THEXTON

- Made of Corrosion-Resistant Aluminum
- Basic Garden Hose Hook-Up Cleans Cooling Systems and Heater Cores without Disassembly

Cooling System Back Flush Tool

SKU **750008** **27⁹⁹** **SAVE \$12**
24506 REG. \$39.99

- Non-Corrosive Aluminum
- Easy to Use
- Connects to Standard Hose 1/2", 5/8" and 3/4" Hose Fittings
- Made of Non-Corrosive Aluminum



OEM TOOLS

Offer Good Through December 31, 2025

To Confirm Price, Availability and Ordering Instructions on OSB, Call 901-300-4878

Coolant Exchangers

VCX-1 Vacuum Coolant Exchanger

SKU **OSB** **2,799⁹⁹**
MSS4708001900

- Extremely Fast Service Cycles
- Simple Hook-Up and Operation
- Flexible Adaptation for Most Makes and Models



Coolant Not Included

FluidPRO® MCX-2 Multi-Coolant System Fluid Exchanger

SKU **OSB** **2,879⁹⁹**
MSS4708003000

- Includes System Pressure Test Feature and "Hot Car" Radiator Cap Pressure Release
- Compatible with All Coolant Types for Adaptability
- Contains (2) 7.5 Gallon New Coolant Tanks and (1) 15 Gallon Waste Tank Providing Simple, Rapid Switching from One Coolant to Another
- 3 Minute Service Time for Increased Productivity



Coolant Not Included

MAHLE

Used Fluid Drain

23 Gallon Anti-Freeze Drain

SKU **1485042** **874⁹⁹**
BAL4110-025

- Powder-Coated Green
- 3/4" Cam-Lock Fitting
- All-Steel Tank and Base
- Easy-to-Use Patented Cantilever Mechanism

Premium Drains Capture Used Fluids and Transfer Them to Any Bulk Storage Tank Using a Cam-Lock Kit and Evacuation System



MADE IN USA



Balcrank
Fluid Disposal Systems

Prices subject to change without notice. Prices do not include applicable taxes, vehicles, tires, rims, installation or optional equipment as shown. Please do not return purchases to the store. For information regarding warranty, repair, or any questions or concerns, call 901-300-4878.

AZG0425

SPECIALTY TOOLS

Line Repair Tools

Double Flaring Tool Set

SKU **864647** **35⁹⁹**
25358

- Includes: 5 Adapters: 3/16", 1/4", 5/16", 3/8" and 1/2"
- Chrome Swivel Made of Alloy Steel to Reduce Friction
- Forged Yoke Made with Heat-Treated Steel



OEM TOOLS

Single Flaring Tool

SKU **OSB** **29⁹⁹**
25359

- Ideal for Making 45° Flares in Copper, Aluminum, Brass and Mild Steel Tubing
- Suitable for Tubing Sizes: 3/16", 1/4", 5/16", 3/8", 1/2" and 5/8"
- Makes a Precise Leak-Proof Flare That Fits Properly on Standard Fittings
- Flaring Bars are Heat-Treated for Durability



For OSB, Call 901-300-4878

OEM TOOLS

Bubble Flaring Tool Kit

SKU **592261** **49⁹⁹**
27214

- Designed for Metric Soft Steel Brake Lines Where an "ISO" or Bubble Style Flare is Required
- Forged Yoke is Made of Heat-Treated Steel
- Includes: Flaring Bar, All Adapters Needed for ISO Bubble Flaring and 4 Dies (4.75, 6, 8 and 10 mm)



OEM TOOLS

Fuel Line Repair Assortment Kit

SKU **1392319** **169⁹⁹**
DYNDY-FLA-2

- Kit Includes 23 of the Top Selling Connectors, Fittings and Clamps
- 86 Total Pieces



Dynamic

Pro Series Repair Assortment

SKU **1125882** **499⁹⁹**
AIR78019

- Everything You Need for Transmission and Power Steering Line Repair in One Convenient Kit - 16 Repairs
- 5 Minute Line Repair
- Leak-Free to 2,600 psi
- OE Approved



AIRSEPT
PART SMART

Universal Flaring Set

SKU **954227** **629⁹⁹**
MSC72475-PRC

- Create Perfect Production Quality Flares
- Magnetic Adapter Holder Keeps Adapters in Place
- Tube and Die Set Stabilizing Arm for Easy Tube Forming
- Enlarged Die Set Compression Area for Better Grip of Dies



Mastercool
"World Class Quality"

Disconnect Sets

NAVISTAR® MAXXFORCE® Fuel Line Disconnect Tool Set - 4 Piece

SKU **004112** **34⁹⁹**
25031 REG. \$49.99

SAVE \$15

- 4 Piece Disconnect Tool Set for NAVISTAR® MAXXFORCE® Series 11 and 13 Engines
- Sized to Depress Fuel Release Tabs for Efficient Fuel Line Removal
- 1 Straight and (1) 90° Tool for 11.8 mm Fuel Lines;
- 1 Straight and (1) 90° Tool for 16 mm Fuel Lines

Offer Good While Supplies Last Through December 31, 2025



OEM TOOLS

Fuel Line Disconnect Set

SKU **OSB** **9⁹⁹**
26514

- Disconnects Fuel Lines and Spring Lock Couplings on Ford and Chrysler
- Sizes: 5/16", 3/8", 1/2", 5/8", 3/4" and 7/8"
- High Quality ABS Plastic That Can Easily Stand Up to Daily Usage
- Includes Reusable Holding Tray
- Easily Disconnects Air Conditioning and Quick Connect Fuel Lines

For OSB, Call 901-300-4878



OEM TOOLS

Line Disconnect Set

SKU **1544674** **16⁹⁹**
68941

- Disconnects Fuel Lines and Spring Lock Couplings on Ford and Chrysler
- Sizes: 5/16", 3/8", 1/2", 5/8", 3/4" and 7/8"
- High Quality ABS Plastic that can Easily Stand Up to Daily Usage
- Works on Fuel Lines and Other Quick Disconnect Couplings on Domestic and Import Vehicles
- Angled Handles for Easy Access to Tight Spots
- Sizes Include: 1/4", 5/16", 3/8", 1/2", 5/8", 3/4" and 7/8"



OEM TOOLS

Angled Disconnect Set

SKU **291416** **29⁹⁹**
LIS39400

- Disconnects Spring Lock Couplings on Ford and Chrysler A/C Lines
- Works on Fuel Lines and Other Quick Disconnect Couplings on Domestic and Import Vehicles
- 6 Sizes: 5/16", 3/8", 1/2", 5/8", 3/4" and 7/8"



Lisle

Master Disconnect Tool Set

SKU **291413** **79⁹⁹**
LIS39900

- Contains 8 Tools for A/C and Fuel Lines
- Comes in a Blow Mold Case



Lisle

Coolant Hose Removal Tool Set

SKU **383214** **34⁹⁹**
CAL244TNZ

- Used to Completely Fill the Void in the Connector to Release the Fastener
- 40° Offset Designed for Jobs Up Against the Firewall or in Tight Spaces



Cal-Yan

SPECIALTY TOOLS

TO ORDER, contact your Commercial Sales Manager or go to AutoZonePro.com

SPECIALTY TOOLS

Spark Plug Service

3/8" Drive Magnetic Spark Plug 3 Piece Socket Set
SKU 300140 22891 **19⁹⁹**

- Includes: 5/8", 9/16" and 13/16"



Spark Plug Sockets

SKU	Part #	Drive	Size	Features	Price
082923	22880	3/8"	9/16"	Magnetic	9.99
082933	22887	3/8"	5/8"	Magnetic	9.99
082929	22881	3/8"	18 mm	Magnetic	9.99
082932	22883	3/8"	13/16"	Magnetic	9.99
082934	22889	1/2"	13/16"	Magnetic	9.99
082936	22895	3/8"	14 mm	12 Point Thin-Wall	9.99

3/8" Drive Magnetic Spark Plug Socket Extra Long (5/8")
SKU 300146 22885 **19⁹⁹**

- Hard Chrome™ Finish is Easy to Clean and Protects Against Rust
- Chamfered Ends Make Fastener Engagement Quick and Smooth
- Magnetic and Won't Wear Out or Be Damaged By Oil
- Deep Marking for Easy Identification Knurling Position for Best Finger Gripping
- Length: 6"



3/8" Drive Magnetic Spark Plug Socket Extra Long (9/16")
SKU 300147 22886 **19⁹⁹**

- Length: 6"



Adjustable Spark Plug Boot Pliers
SKU 1340226 25559 **24⁹⁹**

- Jaws Adjust to Five Different Positions for Easy Access to Spark Plug Boots
- Rubber Dipped Jaws Provide a Secure Grip for Damage Free Removal of the Spark Plug Boot
- Hardened Jaws Will Not Bend When Gripping
- Dipped Handle Grips for a Comfortable and Sure Grip

OEM TOOLS®



14 mm x 12 Pt. BMW Spark Plug Socket
SKU 814164 22814 **19⁹⁹**

- Designed with a Universal Joint for the Installation and Removal of Spark Plugs Situated in Tight Spaces
- Durable Chrome Moly Steel Construction
- Overall Length: 3.75"
- Plug Retainer for a Secure Grip



3/8" Drive 14 mm x 12 Pt. Extra Long Spark Plug Socket
SKU 814337 22813 **24⁹⁹**

- Designed with a Universal Joint for the Installation and Removal of Spark Plugs Situated in Tight Spaces
- Durable Chrome Moly Steel Construction
- 12" Extended Reach



12-POINT



Swivel Joint

Spark Plug Boot Pliers
SKU 390900 25542 **13⁸⁵**

- Designed to Remove Hard-to-Reach Spark Plug Boots
- 45° Offset Jaws for Easy Gripping of Wires and Boots



STORE STOCKED

Spark Plug Wire Puller
SKU 532549 25061 **4⁹⁹**

- Insulates Hands from Electric Shock
- Grips Directly on Boot to Prevent Wire Damage



STORE STOCKED

Specialty Sockets

IPR Socket, 3/8" Drive
SKU 912334 25280 **14⁹⁹**

- Remove/Replace IPR without Damaging the Connector
- Applications: Ford 6.0 L and Other Diesel Engines



Oxygen Sensor Socket Set
SKU 1103591 37110 **24⁹⁹**

- Special Purpose, Universal Slotted Socket That Services Hex Vacuum Switches and Oxygen Sensors
- Includes Sockets for Most Applications: 3/8" Drive 7/8" (22 mm) Deep, 3/8" Drive 7/8" (22 mm) Crowfoot, 1/2" Drive 7/8" (22 mm) Deep Crowfoot



OEM TOOLS®

7 Piece Sensor Socket Set
SKU 900823 27189 **54⁹⁹**

- Used for Oil Pressure Switches, Oil Pressure Sending Units and Thermal Sensor Switches
- Includes: 7/8" (22 mm) Offset Extended Oxygen Sensor, 7/8" (22 mm) Offset Oxygen Sensor Socket, 7/8" (22 mm) Vacuum Switch Socket, 7/8" (22 mm) Oxygen Sensor Socket, 1-1/16" (27 mm) Deep Oil Switch Socket, 1-3/16" (29 mm) Oil Sender Unit Socket and 1-1/16" (27 mm) GM Thermal Sensor Switch Socket
- Chrome Vanadium for Toughness



Insulated Tools

10 Piece Insulated Screwdriver Set
SKU 1267942 22593 **29⁹⁹** REG. \$54.99

SAVE \$25

- 1,000V VDE Certified Insulated Screwdrivers
- Insulated Grip Handle and Precision Handle for Added Efficiency
- Insulation Sculpted Directly Onto Blade for Permanent Bonding
- Quick-Release Mechanism for Effortless Blade Change
- Exchangeable Blades with a Slim Tip to Fit Tight Terminal Blocks
- Durable Tool Pouch Included for Easy Organization
- Includes 4 Slotted Blades



OEM TOOLS®

Offer Good Through December 31, 2025

Prices subject to change without notice. Prices do not include applicable taxes, vehicles, tires, rims, installation or optional equipment as shown. Please do not return purchases to the store. For information regarding warranty, repair, or any questions or concerns, call 901-300-4878.

AZG0425

SPECIALTY TOOLS

Fuel Pump Tools

OEM TOOLS®

Fuel Tank Adapter

SKU 1407554 24832 **199⁹⁹**

- Makes Fuel Tank Removal Safe and Easy
- Works with Most Transmission Jacks
- Includes: 2 Nylon Straps to Secure Tank
- Foam Rubber Pads Protect Tank



Bed Lifter

SKU OSB STK35885 **339⁹⁹**

- Designed to Lift Truck Beds Safely and Easily
- Lifting Brackets Adjusts to Evenly Distribute Weight



For OSB, Call 901-300-4878

STECK

Terminal Tools

OEM TOOLS®

19 Piece Master Terminal Tool Set

SKU 447159 27169 **129⁹⁹**

- Latest Tools for Coolant Sensors, Wiring Harnesses and Terminal Blocks on Most Modern Vehicles
- Eliminates Potential Damage to Wires or Terminal Blocks
- Application Chart Included Inside Storage Case

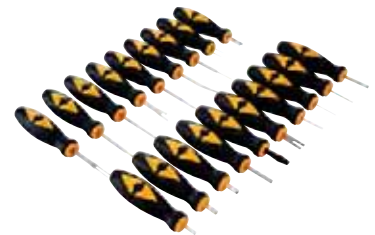

Fuel Pump Module Spanner Wrench

SKU 110278 25156 **34⁹⁹**

- Removes and Installs the Fuel Pump Retaining Ring



OEM TOOLS®

Fuel Tank Lock Ring Tool

SKU 751721 24398 **39⁹⁹**

- Ford F150 Trucks (2004 - Newer); Chrysler/Dodge Mini-Vans, PT Cruiser, Dakota, Durango (2004 - Newer); Chevy 1/2 Ton and 3/4 Ton Trucks (2004 - Newer)
- Works with 1/2" Drive Ratchet or Breaker Bar



OEM TOOLS®

Throttle Depressors

OEM TOOLS®

Brake - Accelerator Pedal Depressor

SKU 802194 24232 **49⁹⁹**

- Holds Brake or Accelerator Pedal at Desired Position
- Easy to Adjust
- Extends to 24"
- Suitable for Many Diagnostic Applications

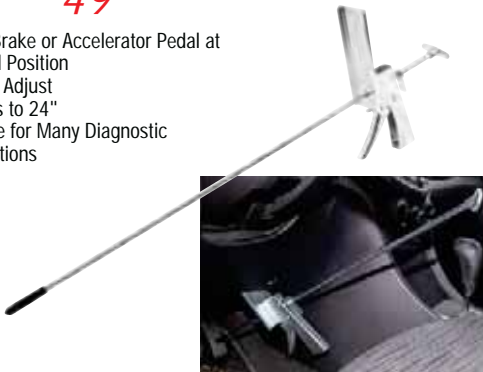

Steering Wheel Holder and Pedal Depressor Set

SKU 802195 24231 **124⁹⁹**

- Holds Steering Wheel in Position for Alignment Adjustments
- Depresses Brake Pedal for Various Brake Checks Including Brake Lamp Operation
- Simply Hand Squeeze the Actuator to Accomplish Fine Adjustments



OEM TOOLS®

Throttle Pedal Depressor

SKU 222525 LIS48700 **54⁹⁹**

- Holds Throttle at a Constant RPM
- Engage the Nylon Hook Under the Steering Wheel, Then Extend the Depressor Rod to the Accelerator Pedal
- Length: 40"

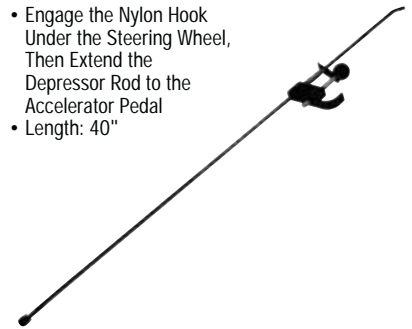

Lisle

Wire Strippers

9-1/2" Terminal Crimping Pliers with Cutter

SKU OSB 25196 **14⁹⁹**

- For Insulated and Non-Insulated Wire Connectors and Terminals
- Specially Hardened Wire Cutter in Nose
- Tapered Nose for Working in Confined Spaces
- For 10 to 22 AWG Wire Connect
- Plastic-Dipped Comfort Handles Minimize Fatigue



8-1/4" Wire Stripper/Cutter/Crimper/Bolt Cutter

SKU 312821 25193 **14⁹⁹**

- AWG: 10, 12, 14, 16, 20 and 22 Stranded
- AWG: 8, 10, 12, 14, 16 and 18 Solid
- Crimps 7 and 8 mm Ignition Terminals



OEM TOOLS®

For OSB, Call 901-300-4878

7" Wire Stripper Crimper - Cutter

SKU 751657 24452 **24⁹⁹**

- Strips 20-12 Gauge Insulated and Non-Insulated Wire
- Use for Wire Cutting and Stripping, as Pliers for Grabbing and Twisting or for Crimping of Insulated and Non-Insulated Connectors
- Industrial Finish with Red Textured Grips



6-in-1 Long Nose Pliers

SKU 177785 22631 **24⁹⁹**

- Wire Strippers: 10, 12, 14, 16, 18, 20, 22 AWG
- Wire Crimper: 10 - 20 AWG
- Ergonomic Pistol Grip for Added Leverage
- Ideal for Hard-to-Reach Spot



SPECIALTY TOOLS

TO ORDER, contact your Commercial Sales Manager or go to AutoZonePro.com

SPECIALTY TOOLS

Circuit Testers

Memory Saver/Parasitic Drain Monitor

SKU **1580963** **199⁹⁹**
PWPPDRAW

- Connects Via 16Pin OBDII Port and Supplies Power and Monitors the Vehicles Electrical System for Parasitic Draw
- View and Record Data Via Bluetooth on Power Probe Link App
- Graphing Mode for Displaying Voltage and Amperage as a Wave Form
- Readings are Displayed on the LCD Screen
- Capable of Delivery Up to 10 Amps Continuous Current



ECT3000 Electrical Circuit Tracer

SKU **1392338** **149⁹⁹**
PWPECT3000B

- Automatic and Manual Sensitivity Locking
- Arrow Indicates Direction to Short
- Signal Distance Indicator Bar
- 10 Minute Auto Shut Off
- Ergonomic Housing



Digital Display Circuit Tester

SKU **568468** **39⁹⁹**
24451

- Detect Voltage, Power, Ground and Circuit Condition
- Display Provides Precise Voltage
- Voltage: 5 to 30V DC
- Computer Safe - DO NOT Use on Airbags



OEM TOOLS®



Voltage Display

Coiled Cord Circuit Tester

SKU **422468** **14⁹⁹**
25886

- Circuit Tester with a Stretchable and Retractable 12' Cord for Long Circuit Runs



OEM TOOLS®

One Handed Wire Piercing Circuit Tester

SKU **422469** **14⁹⁹**
25887

- Bright Hi-Vis 12' Heat and Oil Resistant Coiled Cord
- Molded Strain Relief for Long Life
- Hangs on Wire for Hands-Free Operation
- 6, 12 and 24 Volt Systems



OEM TOOLS®

Heavy Duty Circuit Tester

SKU **006511** **29⁹⁹**
25019

- For Testing 6 and 12 Volt Systems for Wire Breaks, Shorts, Fuses, Lamps, Relays, Armatures and More



OEM TOOLS®

Relay Tools

Relay Puller Pliers

SKU **291342** **34⁹⁹**
LIS46950

- For Removing Electrical Relays on Most Domestic and Import Vehicles
- Allows Relay to Pop Free from Socket with Less Chance of Damaging the Relay



LifeLine

Relay Circuit Tester

SKU **383450** **119⁹⁹**
27211

- Cut Relay Related Diagnosis Time by 75%
- Identify at the Push of a Button if a Wire, a Part, or a Relay is Defective
- Test an Entire Circuit from the Battery to the Component
- Bypass Relays to Do Compression Test, Fuel Pressure Test, A/C Fill, etc.
- Kit Includes: Tester, 6 Popular Relay Leads and 1 Universal Relay Lead
- Comes in a Sturdy Blow Mold Case



OEM TOOLS®

Windshield Tools

Compact Windshield Wiper Arm Puller

SKU **191681** **9⁹⁹**
25319

- Easily Removes Wiper Arms on Most Domestic and Foreign Vehicles
- Will Not Damage Wiper Arm or Hood Cowling During Removal
- Features Turning Knob for Fast Work and Forged Body for Strength
- Compact Design Works Great in Tight Spaces



OEM TOOLS®

Window Holder Tool

SKU **191670** **14⁹⁹**
25309

- Works on All Cars and Trucks with a Top Door Frame
- Loop Cable Over Door Frame and Attach Suction Cups to Each Side of Glass
- Window Glass is Securely Held Above the Door While Work is Performed

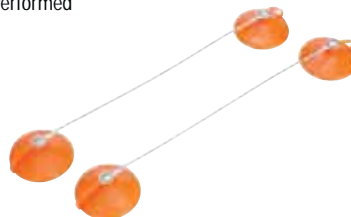

OEM TOOLS®

Universal Wiper Arm Puller

SKU **265136** **39⁹⁹**
25339

- For Pulling Front and Rear Wiper Tight Fitting Wiper Arms
- Suitable for Most Wiper Arms Including Audi®, VW®, BMW®, Ford®, Chevrolet®, Mercedes-Benz® and Others
- Designed to Prevent Damage to Wiper Arm Nozzle

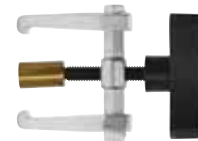

OEM TOOLS®

Double Head Suction Cups

SKU **291351** **14⁹⁹**
24246

- Twin Head Suction Cups Help Remove Windshields
- ABS Rubber Cups Grab Hold of Glass
- Flexible Handle Bends to Windshield
- Quick Release Levers for One-Hand Operation



OEM TOOLS®

18" Professional Windshield Knife

SKU **480782** **29⁹⁹**
CAL53100

- Constructed of Heavy Duty Steel and Aluminum with a Padded Ergonomic Handle



Cal-Vet Tools

Prices subject to change without notice. Prices do not include applicable taxes, vehicles, tires, rims, installation or optional equipment as shown. Please do not return purchases to the store. For information regarding warranty, repair, or any questions or concerns, call 901-300-4878.

SPECIALTY TOOLS

Torque Wrenches

3/8" Drive (10-80 Ft/Lb.)
SKU 177722 **69⁹⁹**
25694

1/2" Drive (10-150 Ft/Lb.)
SKU 012651 **79⁹⁹**
25689

1/2" Drive (25-250 Ft/Lb.)
SKU 177715 **114⁹⁹**
25695



3/4" Drive Torque Wrench (50-400 Ft/Lb.)
SKU 1103610 **199⁹⁹**
37309 REG. \$299.99

SAVE \$100
Ideal for Replacing Ford F150 Front Wheel Bearings
• Range: 50-400 Ft/Lb. and 84.7-559.2 N-m
• Increments 2.5 Ft/Lb.



Offers Good While Supplies Last Through December 31, 2025

1/4" Drive Deflection Beam Torque Wrench
SKU 752621 **29⁹⁹**
25439

• Can Be Used on a Number of Fastening Applications Including Boats, Cars, Motorcycles and Bikes
• 80 In/Lb. (0-9 Nm) in Maximum Working Torque Dual Range Scale Features In/Lb. and Newton Meter Measurement
• Delivers Accurate Measurements When Used Clockwise or Counterclockwise
• Hard-Spring Steel Beam Resists Bending to Deliver Precise Readings



3/4" Drive Torque Multiplier
SKU 191056 **474⁹⁹**
25683

• Increased Torque Output Converts Low Torque (Max. 650 Ft/Lb.) to High Torque (2,200 Ft/Lb., 3000 Nm) with Planetary Gear Set for Heavy Duty Tightening and Loosening
• Input Drive: 3/4"
• Output Drive: 1"



3/8" Drive Torque Wrench (25-250 In/Lb.)
SKU 133657 **44⁹⁹**
25685

• 45 Tooth Round Head Ratchet
• Both Clockwise and Counterclockwise Operation



3/8" Drive Click Style Torque Wrench
SKU 133658 **44⁹⁹**
25686

• Precision Torque Control by 45-Tooth Ratchet Head
• Audible Click When Desired Torque is Reached
• Both Clockwise and Counterclockwise Operation
• High Grade Spring Steel Torque Mechanism

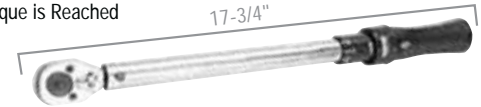

1/2" Drive Click Style Torque Wrench (25-250 Ft/Lb.)
SKU 133659 **79⁹⁹**
25687

• Both Clockwise and Counterclockwise Operation

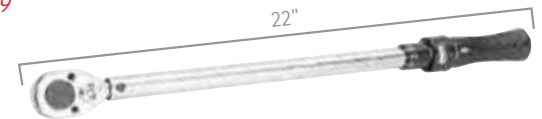

3/4" Drive Professional Micrometer Torque Wrench (100-600 Ft/Lb.)
SKU 217376 **399⁹⁹**
25688

• Right Hand Direction



Micrometer Click Style

Measuring Tools

Tire Tread Depth Gauge
SKU 954233 **59⁹⁹**
CEN3S402A

• Easy-to-Read Digital Display
• Fractional Scale in 1/32" Increments
• Spring-Loaded Plunger



24" Straight Edge
SKU 949552 **41⁹⁹**
25355

• Constructed with 1/4" Thick Cold Rolled Steel
• Durable Powder Coat Finish with Precision Ground Edge
• Hang Hole for Convenient Storage
• Includes Reusable Protective Edge



OEM TOOLS



1" Dial Indicator Set
SKU 954195 **114⁹⁹**
CEN3D101

• Strong Magnetic Base
• Revolution Counter
• Full 1" Range



Indicator Set with Flex Arms and Lock Pliers
SKU 954184 **149⁹⁹**
CEN3D103

• Locking Pliers for Mounting
• Flex Arm for Extra Reach
• Revolution Counter
• Full 1" Range



Extended Range Bore Gauge
SKU 954188 **244⁹⁹**
CEN3D302

• Extended Range of 1.4" to 6"
• Lower Range for Small Applications
• Reach Deep into Cylinders



0-5.5" Digital Rotor Gauge
SKU 954197 **109⁹⁹**
CEN3M430A

• Easy-to-Read Digital Display
• Pointed Anvil for Measuring Grooves
• Inch and Metric Readings



Digital Drum Gauge
SKU 954196 **289⁹⁹**
CEN3B531

• Depth Stops to Improve Accuracy
• Pointed Anvils for Grooves
• Easy-to-Read Digital Display
• 4" to 20" Range Plus Oversize



25' Tape Measure
SKU 1414409 **29⁹⁹**
25699

• Two-Sided Blade Printed in Centimeters and Inches
• 1" Extra Wide Blade
• 10' Standout Reach
• Magnetic End with Dual Hooks
• Heavy Duty Impact-Resistant Case



OEM TOOLS

Prices subject to change without notice. Prices do not include applicable taxes, vehicles, tires, rims, installation or optional equipment as shown. Please do not return purchases to the store. For information regarding warranty, repair, or any questions or concerns, call 901-300-4878.

SPECIALTY TOOLS

TO ORDER, contact your Commercial Sales Manager or go to AutoZonePro.com

SPECIALTY TOOLS

Steck - Lockout Tools

BigEasy™ Glo with Easy Wedge Lockout Kit
SKU 964494 **99⁹⁹**
STK32955

- Glow-In-The-Dark Yellow Allows You to See the Tool at Night or Through Tinted Windows
- Easy Wedge Offers Controlled Opening of the Car Door for Inserting the BigEasy Glo



Glow in the Dark

BigEasy™ Carrying Case
SKU 227873 **44⁹⁹**
STK32935



- Made of Soft, Yet Firm Material to Protect Your BigEasy Kit
- Custom Pockets for the BigEasy, Non-Marring Wedge, Lock Knob Lifter and Easy Wedge
- Makes it Convenient to Stow Your BigEasy Kit in Your Truck



BigEasy™ Lockout Kit
SKU 964491 **49⁹⁹**
STK32900

- High Visibility Pink Powder Coating and Improved Non-Marring Wedge
- Lock Knob Lifter for Cars with Flat Lock Knobs at the Top of the Door
- Paint Protector Reduces Friction Between the Car Door and the BigEasy

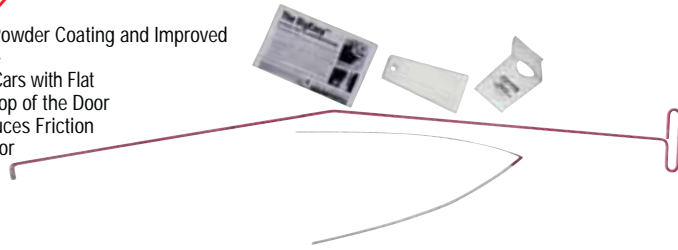

BigEasy™ Easy Wedge (Inflatable)
SKU 964493 **44⁹⁹**
STK32922

- Inflatable Controlled Opening of Car Door for Insertion of the BigEasy



Access Tools - Lockout Tools

Emergency Response Kit Long Case
SKU 1339730 **199⁹⁹**
AETERKLC

- Most Popular Accessories, Gets into Any Vehicle
- Designed by First Responders
- Emergency Ready
- Includes: Quick Max Long Reach Tool, Flex Max, Button Master, Super One Hand Jack Tool, Super Air Wedge, Glassman Wedge and Button Strip Tool



Button Master
SKU 1189051
AETRCBM

49⁹⁹

- Flexible Coated Long Reach Tool
- Retractable Loop with Grip Cover
- Grab Vertical Door Buttons with Ease
- Approximately 38" in Length When Straightened
- Most Flexible and Versatile Version of All the Button Masters



AccessTools

One Hand Jack Set
SKU 1145698 **119⁹⁹**
AETOHJS4

- Easy-to-Use Car Opening Kit
- Soft Shielded Long Reach Tool That Won't Scratch Paint
- Air Wedge with Stiff Insert for Easy Insertion
- Vertical Button Tool One Hand Jack for Quick, Damage-Free Insertion of the Air Jack



Rivet Tools

500 Piece Aluminum Rivet Assortment
SKU 271150 **9⁹⁹**
68109

- Includes: 1/8" and 3/16" Rivets 1/4", 5/16" and 3/8" Long



1/8" x 1/4" (120 Pc.)

1/8" x 5/16" (120 Pc.)

1/8" x 3/8" (120 Pc.)

3/16" x 5/16" (70 Pc.)

3/16" x 3/8" (70 Pc.)



Rivet Tool Kit
SKU 94877 **139⁹⁹**
MAR39001KIT

- 50 each: SB4-2, SB4-4, AB4-2A
- 25 each: SC4-4, AB6-2



Rivet Tool Kit
SKU 94879 **139⁹⁹**
MAR39003KIT

- Includes 40 each: SSB4-2S, SSB4-3S, SSB4-4S, SSBL4-2S



Big Daddy® Hand Riveter
SKU 094886 **329⁹⁹**
MAR39031

Sets Large Diameter Blind Rivets.

- Double Gear Reduction System Easily Sets from 1/8" to 1/4" Diameter Klik-Fast Rivets in All Alloys Including 1/4" Klik-Split® Rivets
- Comes with 5/32", 3/16" and 1/4" Nose Pieces Stored in the Body



See More Marson Rivet Tools on AutoZonePro.com

Prices subject to change without notice. Prices do not include applicable taxes, vehicles, tires, rims, installation or optional equipment as shown. Please do not return purchases to the store. For information regarding warranty, repair, or any questions or concerns, call 901-300-4878.

AZG0425

47

SPECIALTY TOOLS

Slide Hammer Pullers

5 Lb. Slide Hammer
SKU 1103572 37033 **54⁹⁹**

- For Use with OEMTOOLS® 27032 Axle Puller, 27058 Inner CV Joint Puller, 27059 Pilot Bearing Puller, and Other Puller Attachments with 5/8" X 18 Threads
- For a Variety of Pulling Tasks
- Chrome Plated Main Shaft
- Thread: 5/8" x 18



9 Way Slide Hammer Puller Set

SKU 1335798 37191 **139⁹⁹**

- Pulls Flange-Type Rear Axles and Most Front Wheel Drive Hubs
- Internal and External Jaws Provide a Variety of Combinations to Pull Bearings, Gears and Seals
- 2-Way and 3-Way Cross Blocks
- Includes: Grip Wrench Adapter and Dent Puller Attachment
- Designed for Use with Other 5/8" x 18 Thread Slide Hammer Attachments

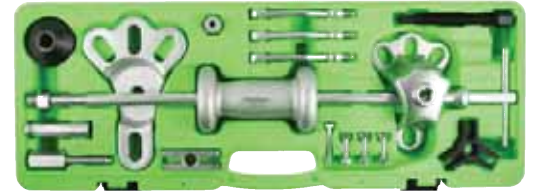

OEM TOOLS®

Rear Axle Puller Set

SKU 094801 27202 **114⁹⁹**

- Use for Flange-Type Rear Axle and Bearing Removal on Most Late Model Passenger Cars and Light Trucks
- Slide Rod and Adapters are 5/8" x 18 Standard Threads



VW/Audi Fuel Injector Puller Kit

SKU 1103636 37383 **59⁹⁹**

- Includes: 1 Mini Slide Hammer, 1 Installation Tool, 2 Special Puller Attachments and 3 Knurled Collars
- Comes in a Sturdy Blow Mold Case
- Used with All 2.0 L TSI/FSI/TSFI Engines



Multi-Purpose Puller

Multi-Purpose Bearing and Pulley Puller Set

SKU 900824 27190 **189⁹⁹**

- Use on Pitman Arms, Timing Gears, Carrier Side Bearings, Crankshaft Pulleys and More
- 20 Piece Set Includes: 6 Jaws, 2 Bar Housings 6 Bolts and 2 Retainers
- Capacity: 6-10 Tons (Depending on the Jaws)
- Combine to Create 10 Different Pullers



OEM TOOLS®

Retainer Remover

Brake Cylinder Retainer Remover

SKU 265111 25268 **14⁹⁹**

- Expands and Holds Special Retainer So the Brake Cylinder May Be Removed
- Releases the Spring Clip Retainer That Attaches the Rear Brake Cylinder to Backing Plate



OEM TOOLS®

Lock and Snap Ring Pliers

Professional Internal/External Snap Ring Pliers

SKU 1340233 25097 **24⁹⁹**

- Unique Jaw Design Makes it Easy to Switch from Internal to External Configurations
- For Both Internal and External Rings
- Alloy Steel and PVC Grip with Storage for Tips
- Includes: 3 Pairs of Tips and Hex Key, 1 Pair Straight Tips for 1.2 mm and 1.8 mm, 2 Pair 90° Tips for 1.2 mm and 1.8 mm



Angle Tip Lock Ring Pliers

SKU 191055 25354 **19⁹⁹**

- For Spreading Snap Rings Found on Brakes, Pedal Shafts, Clutch Shafts, Transmissions, Machine Tools and Piston Rings
- Constructed with Durable Drop Forged Steel Alloy
- Spring-Loaded Jaws Feature a Scored Outside Edge for a Secure Grip
- Vinyl Grip Handles for Added Comfort and Control
- Spread: 3/4"
- Length: 8-1/4"



10 Piece Snap Ring Pliers Set

SKU 900819 27180 **119⁹⁹**

- Includes:
 - (2) 5-1/2" Bent Pliers (0.038" and 0.047" Tip),
 - (2) 6" Straight Pliers (0.038" and 0.047" Tip),
 - 7-1/2" Bent Pliers (0.070" Tip),
 - 8" Straight Pliers (0.070" Tip),
 - 8-1/2" Bent Pliers (0.090" Tip),
 - 9" Straight Pliers (0.090" Tip),
 - 1 Pick Tool and 1 Hook Tool
- For Both Internal and External Rings
- Constructed with Heat-Treated Chrome Moly Steel
- Comes in Sturdy Blow Mold Case

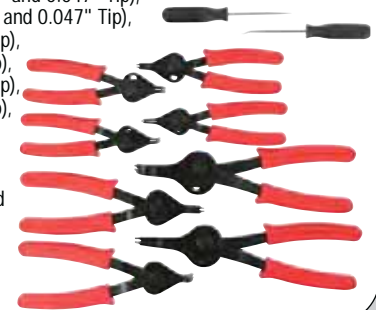

OEM TOOLS®

Jaw Pullers

- Adjustable and Reversible Jaws with 2 and 3 Jaw Configurations Available
- Remove Gears, Pulleys and Other Components in Various Applications, from Automotive to Heavy Duty Vehicles and Equipment
- Heavy Duty Forged Construction with Chrome and Black Oxide Finishes Protect Against Corrosion

SKU	Part #	Capacity	Jaw	Spread	Reach	Price
246386	25902	1 Ton	2/3 Jaw	3"	3-1/4"	19.99
246387	25903	5 Ton	2/3 Jaw	4"	4-3/4"	29.99
70134	25901	2 Ton	2/3 Jaw	6"	4-3/4"	41.99
OSB	25914	5 Ton	2 Jaw	6"	3-1/4"	44.99
231202	25919	5 Ton	2/3 Jaw	7"	5-1/2"	51.99

For OSB, Call 901-300-4878



25903



OEM TOOLS®

Prices subject to change without notice. Prices do not include applicable taxes, vehicles, tires, rims, installation or optional equipment as shown. Please do not return purchases to the store. For information regarding warranty, repair, or any questions or concerns, call 901-300-4878.

Cam/Crankshaft Tools

Crank Bolt Sockets

Deep Counter-Weighted Sockets Provide Increased Torque to Break Loose Stubborn Crank Bolts

- Applications: Honda-Acura, Models: Accord, Civic, Pilot, CRV, Odyssey, CL TL Integra, MDX, Vehicles. Plus Toyota-Lexus, Models: Camry, Corolla, 4Runner, Sequoia, ES300, LS400 Vehicles and More

17 mm
SKU 912348 14⁹⁹
25275

19 mm
SKU 1335801 19⁹⁹
25290

21 mm
SKU 912343 19⁹⁹
25273

22 mm
SKU 070132 19⁹⁹
25300

26 mm
SKU 919500 19⁹⁹
25278

27 mm
SKU 919497 19⁹⁹
25279



OEM TOOLS®



6 Piece Crank Bolt Socket Set

SKU 919501 114⁹⁹
25276

- Includes: 17, 19, 21, 22, 26 and 27 mm Deep Counter-Weighted Sockets
- Provides Increased Torque to Break Loose Stubborn Crank Bolts
- Applications: Honda-Acura, Models: Accord, Civic, Pilot, CRV, Odyssey, CL TL Integra, MDX, Vehicles. Plus Toyota-Lexus, Models: Camry, Corolla, 4Runner, Sequoia, ES300, LS400 Vehicles and More
- Constructed with Durable Chrome Moly Steel

Universal Pulley and Fan Clutch Holder

SKU 547013 89⁹⁹
27281

- Fits Many Different Fan Clutches, Cam and Crank Pulleys with Slots or Holes Adjustable Diameter: 1-1/2" to 8-5/8" Pin Sizes: 6-10 mm, 8-11 mm, 10-12 mm and 11-16 mm
- Comes in Blow Mold Case



OEM TOOLS®

5 Piece Master Cam/Timing Gear Clamp Set

SKU 383452 24⁹⁹
27210

- Covers Most Single, Twin Cam and Quad Cam Engines
- Locks Camshaft to Hold Valve Timing During Timing Belt Replacement



OEM TOOLS®

Ford Cam Tool 1.6 Liter

SKU 1103640 19⁹⁹
37380

- Designed to Hold the VCT Sprockets in Position During Timing Belt Installation or Camshaft Service
- Alignment Tool Services:
Ford Fiesta (2011 to 2014),
Ford Escape (2013 to 2014),
Ford Fusion (2013 to 2014),
Ford Transit (2013 to 2014)



OEM TOOLS®

Ford 2.0 L, 2.3 L, 2.5 L Cam Tool Kit

SKU 626108 17⁹⁹
24448

- Applications: 2.0 L DOHC Engines Found in Ford and Mercury (1994 to 2003), 2.5 L DOHC, 2.3 L DOHC 4V and 2.0 L DOHC Engines in Ford, Mercury and Mazda (2004 to 2012) and 2.0 L DOHC Engines in Ford Probe (1993 to 1994)



OEM TOOLS®

Ford Timing Chain Locking Wedge Tool

SKU 012647 14⁹⁹
24207

- For 2005-14 5.4 L and 4.6 L 3V OE Type Tool Allows for Easy Cam Changes without Removing the Timing Cover
- Compact and Easy to Use
- OE Type Tool
- For 5.4 L and 4.6 L 3V (2005-2014)



OEM TOOLS®

DOHC Cam Lock Holder

SKU 291419 59⁹⁹
LIS36880

- This Versatile Tool Easily Locks and Holds Both Camshaft Sprockets Firmly in Place
- Preserves the Engine Timing During Belt or Chain Replacement

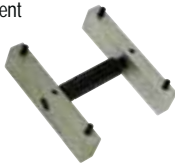

Life

Pilot Bearing Puller

SKU 775523 34⁹⁹
25089

- Use to Pull Pilot Bearing from End of Crankshaft
- Plate Prevents the Jaws from Spinning When Force is Applied
- Spread Range: 1/2" to 1-1/2"
- Reach Range: 3/16" to 11/4"



OEM TOOLS®

Pilot Bearing Puller Attachment

SKU OSB 19⁹⁹
27059

- Use with OEMTOOLS 37033 and 27202 Slide Hammer Pullers
- Threaded with Both 5/8" x 18 and 3/4" x 16 Threads to Fit Most Slide Hammers



OEM TOOLS®

Ford Master Timing Kit

SKU OSB 284⁹⁹
CTA2221

- Includes: Harmonic Balancer Holder, Camshaft Alignment Tool, VCT Alignment Tool, Crankshaft Positioning Tool, Crankshaft Vibration Dampener Alignment Tool, 3 Pc. Wedges and Camshaft Timing Kit
- Services Ford, Mazda and Lincoln 1.4 L, 1.5 L, 1.6 L, 2.0 L, 2.3 L, 2.5 L, 3.0 L and 3.5 L Engines



CTA

For OSB, Call 901-300-4878

For OSB, Call 901-300-4878

Flywheel Turner

SKU 1207891 19⁹⁹
25556

- Holds Flex Plates and Fly Wheels to Allow Clutch, Transmission and Crankshaft Service
- Spring Tensioned to Keep the Wrench Securely Engaged
- Sure Grip Handle



OEM TOOLS®

Universal Camshaft Bearing Tool

SKU 191677 264⁹⁹
27143

- Removes or Inserts Camshaft Bearings in Nearly All Engines
- Set Includes: Driving Shaft, Driving Shaft Extension, Expander Unit, 5 Split Driving Plugs, 2 Driving Collars and Centering Cone
- Easy on Bearings
- Range: 1.125" to 2.69"



OEM TOOLS®

ENGINE SERVICE

Valve & Cylinder Head Tools

Combustion Leak Detector
SKU **1103608** **34⁹⁹**
37145

- Test for Internal Combustion Leaks on Gasoline Engines
- Fluid Color Changes to Yellow When a Combustion Leak is Present
- Comes in a Sturdy Blow Mold Case
- Not for Use with Diesel Engines



Combustion Leak Detector Fluid (8 Oz.)
SKU **391381** **9⁹⁰**
25739



STORE STOCKED

Flexible Air Valve Holder
SKU **1392465** **4⁹⁹**
25029

- For 14 mm and 18 mm Spark Plug Holes
- 14" Flexible Hose Reaches into Tight Areas



Valve Keeper Remover and Installer Kit

SKU **011658** **119⁹⁹**
LIS36050

Makes Valve Component Disassembly and Reassembly Fast and Easy

- For Use with Valve Stems from 4.5 to 7.5 mm and 5/16" to 3/8"
- Magnet in Tool Body Captures Keepers
- Smaller Size Works on Toyota 4 Cylinder and Chrysler New World Engine



Lever Valve Spring Compressor

SKU **662780** **79⁹⁹**
24676

- Lever Action Stays Compressed for Easy Valve Lock Removal
- Included Adapters Fit Valve Retainer Diameters from 1" (25 mm) to 1-3/16" (30 mm)
- Compression Range from 1-3/8" to 5-5/8" (35 mm to 142 mm)



Push Rod Remover
SKU **459100** **29⁹⁹**
LIS48300

- Redesigned for Newer 3.5 L and 3.6 L GM Engines - Also Works on GM V6 2.8L, 3.1 L and 3.4L
- Quickly Removes Push Rods to Replace the Intake Gaskets without Removing Rocker Arms



Torque Adapter, Diesel Head Bolt, Ford 6.0 L Power Stroke® Engines
SKU **298191** **19⁹⁹**
24208

- Eliminates the Need to Remove the Truck/Van Cab from the Chassis to Access the Rear Head Bolts
- Eliminates the Need to Remove the Evaporator Housing, Saving 2 Hours of Time and the Additional Cost of Refrigerant Added During A/C Recharging
- Prevents Damage to the Rear Heat Shield
- Use with OEMTOOLS® 27309 3/4" Drive Torque Wrench and OEMTOOLS® 22398 18 mm Socket



Hydraulic Valve Lifter Puller
SKU **424904** **24⁹⁹**
27146

- Use for Removing Many Valve Lifters from Engine Block



Ford Valve Spring Compressor
SKU **626111** **24⁹⁹**
24434

- Applications: 1991 to 2004 Ford Vehicles with 4.6 L, 2V, V8 Engines; 4.6 4V, 5.4 V8 and 6.8 V10
- Works with Engine Removed or Installed, Cylinder Head On or Off
- Not for Triton 5.4 3V



Ford Valve Spring Compressor for 3-Valve Engines

SKU **814391** **29⁹⁹**
24429

- Designed to Compress the Valve Spring without Removing the Camshaft While Servicing the Cylinder Head in Ford 3-Valve Engines
- For Use with Ford 3-Valve 4.6 L and 5.4 L Engines



24" Straight Edge
SKU **949552** **41⁹⁹**
25355

- Use with a Feeler Gauge to Inspect for Distortion on Engine Blocks, Cylinder Heads, Fly Wheels, Main Bearing Saddles, Cam Bearing Saddles, Cam Covers and Bell Housings
- Constructed with 1/4" Thick Cold Rolled Steel
- Precision Ground Edge to +/- 0.001"
- Durable Powder-Coat Finish
- Hang Hole for Convenient Storage
- Includes Reusable Protective Edge



Engine Cylinder Hones

BC 180SC Flex-Hone Tool Kit
SKU **213154** **239⁹⁹**
BRM14353

- 10 Piece Kit Features Flex-Hone Sizes: 10 mm, 1/2", 5/8", 3/4", 7/8", 1", 1-1/4", 1-1/2", 1-3/4" and 2"
- Complimentary Snap Back Hat, 1/2 Pint of Flex-Hone Oil and 1GB Flash Drive



Adjustable Engine Cylinder Hone Deglazer
SKU **OSB** **39⁹⁹**
25041

- Range: 2" to 7" (51 mm to 128 mm)
- Spring Tension Adjusting Nut for Positive Cutting Action at All Speeds
- Includes: 4" Medium Grit Stones



For OSB,
Call 901-300-4878

SKU	Part #	Product	Cylinder Diameter		Price
			Metric	SAE	
341226	BRMBC30018	Flex-Hone™ GB	76 mm	3"	54.99
341232	BRMGB31412	Flex-Hone™ GB	83 mm	3-1/4"	54.99
341239	BRMGB31212	Flex-Hone™ GB	89 mm	3-1/2"	59.99
341317	BRMGB33412	Flex-Hone™ GB	95 mm	3-3/4"	64.99
341325	BRMGB41812	Flex-Hone™ GB	105 mm	4-1/8"	69.99
341332	BRMGB45812	Flex-Hone™ GB	118 mm	4-5/8"	69.99

ADDITIONAL SIZES AVAILABLE - CALL US AT 901-300-4878 OR VISIT AZTOOL1.COM

Prices subject to change without notice. Prices do not include applicable taxes, vehicles, tires, rims, installation or optional equipment as shown. Please do not return purchases to the store. For information regarding warranty, repair, or any questions or concerns, call 901-300-4878.

ENGINE SERVICE

TO ORDER, contact your Commercial Sales Manager or go to AutoZonePro.com

ENGINE SERVICE

Harmonic Balancer Tools

OEM TOOLS*

Harmonic Balancer Puller

OEM TOOLS*

Long Reach Harmonic Balancer/Pulley

OEM TOOLS*

Harmonic Balancer Puller Kit

SKU 818738 25090 **44⁹⁹**

Unique Jaw and Returning Springs for Easy Positioning of the Puller

- Includes: Puller Body, 3 Jaw Puller, 3 Jaw Retaining Pins, 3 Wave Washers, Pressure Screw
- Insert Rods: 4", 5-13/32", 6-1/2" and 7-13/32"
- Used on Many GM, Ford, Mitsubishi and Chrysler Engines



- Includes: Yoke, Pressure Screw and Pulling Screws
- Floating Swivel Prevents Damage to Shaft Ends
- Ideal for Any Shop or Garage
- Pulling Balancers and More
- Heat-Treated for Strength and Durability

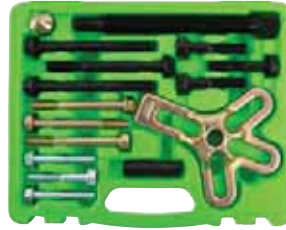

Long Reach Harmonic Balancer/Pulley Installer for GM, Ford and Chrysler

SKU 1103550 37306 **39⁹⁹**

- Use to Install Crank Pulley or Underdrive Pulley on Many Late Model Ford, GM, Dodge and Chrysler Vehicles with V8 and V6 Engines
- Includes: M16 x 2.0 mm (GM), M14 x 1.5 mm (Dodge, Chrysler and Jeep), M12 x 1.75 mm (Dodge Chrysler and Jeep) and M12 x 1.5 mm (Ford)



Universal Pulley and Fan Clutch Holder

OEM TOOLS*

SKU 547013 27281 **89⁹⁹**

- Fits Many Different Fan Clutches, Cam and Crank Pulleys with Slots or Holes
- Adjustable Diameter: 1-1/2" to 8-5/8"
- Pin Sizes: 6-10 mm, 8-11 mm, 10-12 mm and 11-16 mm
- Comes in Blow Mold Case



Harmonic Balancer Installer

OEM TOOLS*

SKU 1103603 37144 **29⁹⁹** REG. \$49.99

SAVE \$20

- Use to Properly Install Harmonic Balancers without Damage
- Thread Adapters: 12 mm x 1.5, 14 mm x 1.5, 16 mm x 2.0, 7/16" x 20, 1/2" x 20, 9/16" x 18, 5/8" x 18, 3/4" x 16

Offer Good While Supplies Last Through December 31, 2025

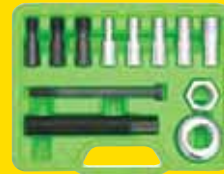

Honda/Acura Crank Damper Holder Tool

OEM TOOLS*

SKU OSB 26507 **19⁹⁹**

- For Removal and Installation of the Crank Bolt on Honda/Acura Engines (1990 - Newer)
- Designed to Hold Crankshaft Pulley to Install/Remove Crankshaft Pulley Bolt
- 50 mm Hex
- 1/2" Drive Works with Ratchet or Breaker Bar



For OSB, Call 901-300-4878

Harmonic Balancer/Steering Wheel Puller

OEM TOOLS*

SKU 532440 25053 **28⁹⁹**

- Removes Balancers, Steering Wheels, Pulleys and/or Gears with Tapped Holes
- Floating Swivel Helps Prevent Damage to Shaft End
- Includes: 3 Nickel-Plated 5/16"-18 x 2" Coarse Pitch Bolts
- Includes: 3 Yellow-Plated M8-1.25 x 80 mm Metric Bolts
- Includes: 3 Black Oxide-Plated 3/8"-16 x 4" Coarse Pitch Bolts
- Heat Treated Yoke Forged from High-Strength Alloy Steel for Longevity and Resilience



2.7/5.2 L Ford EcoBoost Long Reach Harmonic Balancer/Installer

Cal-Yan Tools

SKU 1392336 CAL38710 **49⁹⁹**

- Designed to Achieve Easy Installation of Harmonic Balancers on Ford EcoBoost
- Can Be Used On 2.7 L, 3.0 L, 3.3 L and 5.0 L Engines in Ford/Lincoln Cars, Trucks and SUV



Ratcheting Harmonic Balancer Pulley Puller

Cal-Yan Tools

SKU 1189050 CAL38000 **89⁹⁹**

- Eliminates Need to Remove the Radiator
- Push Turn Click Design
- No Need for Bolts
- Applications: FORD 5.0 Coyote, GM 5.3 L, 5.7 (LS1), 6.0 (LS2), 6.2 (LS3), 7.0 L and Most Three and Six-Spoke Harmonic Balancers/Pulleys



Hex Oil Pump Primers

OEM TOOLS*

- Used to Prime the Lubricating System of a Rebuilt Engine Prior to the First Start, Preventing a Dry Start
- Connects to the Oil Pump Shaft Through the Distributor Hole
- For Use with 3/8" Reversible Drill



Ford 5/16" SKU 534545 27062 **9⁹⁹**



Ford 1/4" SKU 534537 27061 **9⁹⁹**

Piston Tools

Piston Ring Compressor

SKU 013641 24682 **14⁹⁹**

- 1-1/2" Deep, Low Friction Wrinkle Band
- Fits 3" to 5" Pistons



OEM TOOLS*

Piston Ring Expander Pliers

SKU 003509 25083 **29⁹⁹**

- Eliminates Piston Ring Damage and Distortion During the Installation and Removal Process Dipped Rubber Handles for Improved Grip
- Diameter Range: 3-1/8" (80 mm) to 4-5/8" (120 mm)

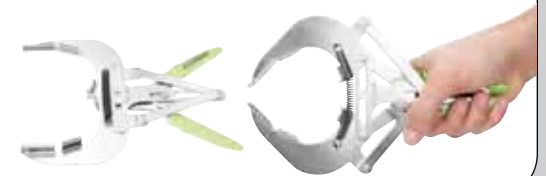

Alternator Tools

Alternator Decoupler Pulley Tool Kit

SKU 300124 37261 **24⁹⁹**

- Works on Both Overriding Alternator Decoupler (OAD) and One-Way Clutch (OWC) Pulleys
- Tools May Be Used While the Alternator is On or Off
- Includes 2 Pulley Sockets and 3 Shaft Bits
- Comes in a Sturdy Blow Mold Storage Case



Alternator Decoupler Pulley Service Set

SKU 1103629 37275 **44⁹⁹**

- Removes and Installs Many Alternator Decoupler Pulleys on the Most Popular Vehicles
- Works on Both Overriding Alternator Decoupler (OAD) and One-Way Clutch (OWC) Pulleys



OEM TOOLS*

Prices subject to change without notice. Prices do not include applicable taxes, vehicles, tires, rims, installation or optional equipment as shown. Please do not return purchases to the store. For information regarding warranty, repair, or any questions or concerns, call 901-300-4878.

AZG0425

ENGINE SERVICE

Diagnostic

Compression Tester Gauge Set

SKU **1103601** **39⁹⁹**
37138

- Use to Test Compression 0 to 300 psi on 14 mm and 18 mm Spark Plug Ports and Determine Engine Mechanical Condition



8 Piece Noid Light Set

SKU **1103589** **29⁹⁹**
37161

- Includes: GM TBI, GM SCPI, GM PFI, Ford TBI, GEO TBI, Bosch PFI, Bosch Type 2 and GM Multec 2
- See-Through Design to Check Electrical Pulses



Vacuum Pump Tester Power Steering and Brake Bleeder Set

OEM TOOLS

SKU **1103570** **49⁹⁹**
37070

- Brake Bleeding Kit Bleeds Brakes, Clutches or Other Hydraulic Systems
- Kit Includes: Vacuum Pump Reservoir Jar with Transfer Lid, Storage Lid, Brake Bleeding Adapter Package, Steering Pump Adapters and Tubing



Exhaust Back Pressure Tester/Gauge

SKU **1103604** **79⁹⁹**
37263

- Oxygen Sensor Adapter is M12 and M18 Thread
- 6' Hose Allows User to Test from Driver's Seat
- Test for Restricted Exhaust Systems



Gas Engine Combustion Leak Tester

SKU **1103608** **34⁹⁹**
37145

- Test for Internal Combustion Leaks on Gasoline Engines
- Fluid Color Changes to Yellow When a Combustion Leak is Present
- Designed for Professional Auto Mechanics and Heavy Duty Applications
- Not for Use with Diesel Engines



Use with 25739
Test Fluid Listed on Page 40

Exhaust Tools

OEM TOOLS

Exhaust Donut Stretcher

SKU **390901** **9⁹⁹**
25543

- Easily Grabs onto Mounting Rubber Rings or Doughnut Used on Many Exhaust Systems
- Features an Offset J-Hook
- Large Coated Handle for Comfort

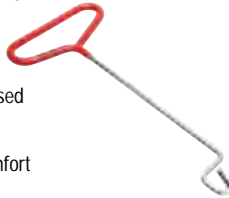

Exhaust Manifold Spreader Set

OEM TOOLS

SKU **504028** **18⁹⁹**
25253TWO

- Use for Reinstalling the Manifold on Small-Block Chevrolets
- Simple Way to Expand Warped Manifold to Align Bolt Holes
- Helps Prevent Cross-Threading of Manifold Bolts
- Works Best When Used in Pairs or Install Before Removing Manifold to Prevent Misalignment



1-1/2" x 2-7/16" Tailpipe Expander

OEM TOOLS

SKU **OSB** **29⁹⁹**
27027

- Extra Long Hex Bar for Convenience



For OSB, Call 901-300-4878

Tailpipe Cutter

OEM TOOLS

SKU **OSB** **29⁹⁹**
27045

- Used to Cut Tail Pipe Range 3/4" to 3-1/4" (19-83 mm)
- Cushion Grip Handles
- Designed for Both On and Off Cutting



For OSB, Call 901-300-4878

Manifold Drill Template - Ford 2V and 3V

OEM TOOLS

SKU **213145** **89⁹⁹**
25251

- Designed to Remove Broken Exhaust Manifold Studs
- For Ford Triton 2V and 3V Engines - 4.6L, 5.4 L and 6.8 L V10
- Drill Depth Gauge Marked on Each Adapter
- Interchangeable 2V and 3V Adapters
- Hi-Vis EVA Tray for Easy Storage and Organization
- Includes: Template, 2V Adapter, 3V Adapter, 2 Stud Alignment Pins, 3/16" and 1/8" Double-Sided Drill Bits and Stud Extractor



Exhaust Pipe Stretcher Kit

Lisle

SKU **080137** **369⁹⁹**
LIS17350

- Expands All Types of Exhaust Pipe, Including Stainless Steel, from 1-5/8" to 4-1/4" in Size
- Use with Impact Wrench to Quickly Stretch Pipes



Manifold Drill Template for GM EcoTec3 5.3 L and 6.2 L

SKU **1125865** **169⁹⁹**
LIS71650

- Removes Broken Exhaust Manifold Bolts without Damaging the Cylinder Head
- Tapered Bolts Allow You to Move from Hole to Hole without Moving Base Plate
- Screw Extractor Removes Broken Bolts
- Includes Bushing Drill Guide When Extractor Cannot Be Used



Lisle

STOP the Knock!

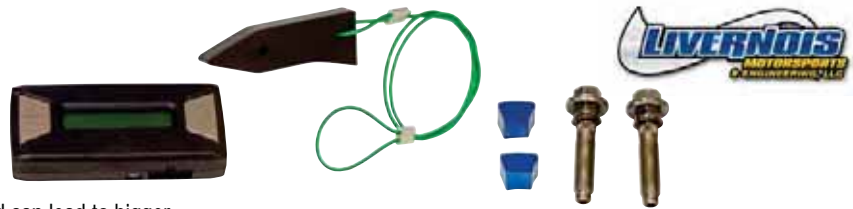

Cam phaser knock on 4.6/5.4 L 3V engines is common in older models and can lead to bigger problems if not fixed. There are millions of trucks on the road with this problem, but until now, there have been few good options to permanently help fix the knock. This kit helps to eliminate any knocking noise heard from the front valve cover/timing cover related to the phasers. These all-in-one kits correct the cam phaser knock on ONE engine.

Stop Saying "No" to Business and Be Confident Your Customers Will Be Satisfied!



This Kit is the Only True, Long Term Repair for Ford Cam Phaser Noise on the Market

- Cam Phaser Noise Repair Kits Include:
- Wedge Tool for Easier Installation
 - Programmer with OBD-II Cable
 - 2 OEM Quality Phaser Bolts
 - 2 Lock Outs
- Ford Cam Phaser Noise Repair Kit
 SKU **OSB LMEF1503V** **699⁹⁹**
 • Fits Ford OEM Cam Phaser

Ford, Livernois and logos featured or referred to on this page are the property of their respective trademark holders | For OSB, Call 901-300-4878

Fan Clutch Tools



Fan Clutch Wrench Set

SKU **1103596** **79⁹⁹** REG. \$99.99

SAVE \$20

- Works on Many of the Ford, Mazda, Dodge, Lincoln, Mercury and Jeep Makes and Models with the Original Fan Clutch Assembly
- Includes Wrench Sizes: 40 mm, 48 mm, 54 mm, 68 mm, 72 mm, 76 mm and 83 mm



Offer Good Through December 31, 2025

Pneumatic Fan Clutch Wrench Set

SKU **291409** **219⁹⁹**
 LIS43300



- Quickly Removes and Installs Fan Clutch When Repairing the Water Pump or Fan Clutch
- Includes Wrench Sizes: 32 mm, 36 mm, 40 mm; 7/8", 1-7/8" and 2"



Fan Clutch Service Set for Mercedes-Benz and BMW

SKU **512958** **174⁹⁹**
 27224



- Removes Lock Nuts on Thermo Viscous Fans Found on Mercedes-Benz, BMW and Many Ford Models
- Special Open-Ended Spanner to Allow Removal and Replacement of the Radiator Fan Hub
- The 3-in-1 Design Allows Servicing of 3 Separate Areas of Repair, Eliminating the Need for 3 Different Tools
- Hub Securing Bar - Used for Securing Water Pump Hub from Rotating During R&R of Fan Clutch Nut
- Applicable: Mercedes M103, 104, 111, 119, 120 OM 602, 603, 605, 606; the 10 mm is Used for Adjusting A/C Belt Tension and R&R of Idler Pulley on Models 420, 560 with V-819 (1986 and Newer)
- Applicable: Mercedes M103 (6 CYL, M104 (6 CYL 4 VLV), M119 (8 CYL 4 VLV) M120 (12 CYL 4 VLV)



Stretch Belt Tools

Stretch Belt Installation Tool

SKU **227301** **18⁹⁹**
 24363



- Works on Both Large and Small Pulleys
- Clamping Jaw Allows User to Position Serpentine Belt without the Belt Slipping Out of the Tool



Stretch Belt Remover and Installer

SKU **255866** **34⁹⁹**
 LIS59370



- Unique Magnetic Faces Hold the Tool in Place on the Pulley
- Compact, One Piece Tool Can Be Used on the Front or Back Side of the Pulley



Pulley and Fan Clutch Holders



Fan Clutch Holding Tool

SKU **209526** **64⁹⁹**
 27171

- For Fan Clutch Repair and Service
- Holds Water Pump Pulley while Servicing Fan Clutch Adjustable Jaws
- Fits Most Water Pump Pulley Bolt Patterns, Including Pressed-On Pulleys
- Jaws Will Lock in Place, Securing Water Pump Bolts
- Longer Handle Provides Leverage for Extra Torque



Universal Pulley and Fan Clutch Holder

SKU **547013** **89⁹⁹**
 27281

- Fits Many Different Fan Clutches, Cam and Crank Pulleys with Slots or Holes
- Adjustable Diameter: 1-1/2" to 8-5/8"
- Pin Sizes: 6-10 mm, 8-11 mm, 10-12 mm and 11-16 mm
- Comes in Blow Mold Case



MADE FOR MECHANICS

THE SPECIALTY TOOLS YOU NEED



CHASSIS & SUSPENSION

Ball Joint Service Kits

XL C-Frame Ball Joint Press Set

SKU **1142924** **149⁹⁹**
25105

- Ideal for Pressing Out Larger Ball Joints on Pick-Up Trucks: Toyota Tacoma and Tundra, Chevrolet 2500-3500 and Tahoe, Dodge Ram 2500-3500 and Ford F350-F550
- Extended C-Frame Allows Use of Multiple Larger Adapters That Standard C-Frame Presses Won't Fit
- C-Frame Constructed with Heavy Duty Forged Steel for Strength and Durability
- For Use with OEMTOOLS® Ball Joint Press Kits and Adapter Sets



Includes
6" and 9"
Pressure
Screws

74 Piece Master Ball Joint Press Kit

SKU **1207895** **999⁹⁹**
37388

- Adapters for Almost Every Car, Van, SUV and Light Duty Truck
- Comprehensive Kit with 70+ Adapters and C-Frame
- Tough Heavy Duty C-Frame is Built to Last
- 2 Heavy Duty Molded Cases are Designed for Storage and Mobility



OEMTOOLS®

Easy to Read
Manual for
Finding
Adapters
Quickly
and Easily



BONUS
VALUE: \$79.99

Hydraulic Ball Joint Separator

25219

With
Purchase of:
37388



Offer Good Through
December 31, 2025

21 Piece Master Ball Joint Press Set

SKU **1142406** **179⁹⁹**
25104

- Removes and Replaces Press-Fit Upper and Lower Ball Joints on 2-Wheel Drive (2WD) and 4-Wheel Drive (4WD) Vehicles
- Includes Adapters with Specialized Cut-Outs to Maneuver Around Obstructions
- Includes Adapters Needed for Removing Upper and Lower Ball Joints on GM, Ford and Chrysler 2WD and 4WD Light-Duty Trucks, Vans and SUVs
- Heavy Duty Forged Steel Alloy C-Frame for the Toughest Jobs — Ideal for Seized Joints



Master Ball Joint Installer/ Remover Adapter Set

SKU **1103612** **89⁹⁹** REG. \$99.99
37310

- Includes All the Receiver Tubes and Removing/Installing Adapters Needed to Work on Many GM, Ford and Chrysler 2 and 4 Wheel Drive Pick-Ups, Vans and SUVs
- Works on Press-Fit Upper and Lower Ball Joints
- For Use with OEMTOOLS® Ball Joint Press Kits and Adapter Sets



SAVE
\$10

Offer Good Through December 31, 2025

Ball/U-Joint Press with 4WD Adapter Set

SKU **1103607** **109⁹⁹**
37089

- Remove and Replace Ball Joints on Many Vehicles
- C-Clamp Frame Press Also Removes and Replaces U-Joints
- Includes Adapters to Service 1/2 to 3/4 Ton 4 Wheel Drive Vehicles Equipped with Dana 44 Series Front Axle



Ball Joint Tools

Ball Joint Separator

SKU **1340232** **39⁹⁹**
37308

- Used for Separating the Ball Joint from the Spindle Support Arm on Domestic and Import FWD Vehicles
- Adjustable for Different Size Ball Joints
- Max. Opening Range: 1-1/8" to 2-1/8"



Low Profile Ball Joint Separator

SKU **1245676** **49⁹⁹**
25112

- Designed for Tight Access Where Many Ball Joint Separators Won't Fit
- For 2005+ Ford, Lincoln and Mercury Applications
- Impact Rated



Polaris ATV Ball Joint Tool

SKU **1142310** **49⁹⁹** REG. \$79.99
24683

- For Removal and Installation of Upper and Lower Ball Joints on Sportsman XP, RZR and Ranger ATVs



Offer Good Through December 31, 2025

Hydraulic Ball Joint Separator

SKU **177718** **79⁹⁹** REG. \$129.99
25219

- Hydraulic Ram Rated to 8 Tons
- Jaw Capacity: 56 mm (2.25")
- Jaw Width: 22 mm (0.86")



Fast. Safe. Efficient.

Offer Good Through December 31, 2025

SAVE
\$50

Ball Joint Separator

SKU **1207880** **24⁹⁹**
26553

- Separate Ball Joints from Spindle Support Arm
- Adjustable for Different Size Ball Joints
- Max. Opening Range: 1-1/8" to 2-1/8"
- Fork Opening Measures 7/8"
- Steel Construction with Black Oxide Pins
- Comes in a Sturdy Blow Mold Case



3/4" Drive Ball Joint Impact Socket 1-59/64"

SKU **662809** **29⁹⁹**
24238

- Used on Chrysler/Dodge Mid-Size Cars, Light Trucks and Vans

3/4" Drive Ball Joint Impact Socket 2-9/64"

SKU **462494** **29⁹⁹**
24215

- Used on Chrysler/Dodge Cars, Light Trucks and Vans



CHASSIS & SUSPENSION

TO ORDER, contact your Commercial Sales Manager or go to AutoZonePro.com

CHASSIS & SUSPENSION

Spring Compressors

OEM TOOLS

Floor Mounted Strut Compressor

SKU 1405961 **324⁹⁹**
37037

- 2,200 Lb. Capacity
- Easy-to-Adjust Bracket Conforms to Spring Rate and Diameter
- Handles Spring Coils 3.5" to 8.75" and Up to 5/8" Diameter
- Max. Spring Height: 19"
- Can Be Securely Mounted to the Floor



Bracket Design Easily Adjusts to Accommodate a Wide Range of Vehicle Strut Sizes

No Special Adapters Required

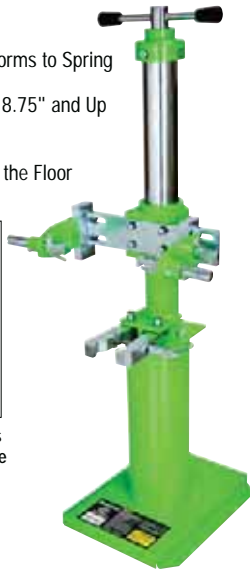

Floor Mounting Hardware Not Included

Model 7600 Strut Spring Compressor

SKU 547959 **1,299⁹⁹**
BRA7600

- Handles the Toughest Applications
- Min./Max. Spring Diameters: 3.5"/11.5"
- No Adapters Required

OEM Approved by Major Automakers



Cart for BRA7600

SKU 547960 **599⁹⁹**
BRA00-0137

Branick

Mechanical Strut Compressor

SKU OSB **Call for Price**
OSPMSC-1000

- Designed to Handle Any Size Spring and Strut Assembly
- Adjustable Extra Strong Clamps for a Perfect Grip
- Top Mounted Tool Tray
- Standard Wall Mount
- Safety Guard Included
- Optional Floor Mount and Third Hand Support Kits



For OSB, Call 901-300-4878

OSP

Coil Spring Compressor

SKU 1103643 **49⁹⁹** REG. \$69.99
37035

OEM TOOLS

SAVE \$20

- Use to Safely Compress the Coil Spring on Most Cars and Light Trucks
- Can Also Be Used When Installing Coil Spring Spacers



Offer Good While Supplies Last Through December 31, 2025

Coil Spring Compressor Set

SKU 1103614 **39⁹⁹**
37200

OEM TOOLS

- Forged Construction for Strength and Durability
- Removes and Installs Coil Springs Quickly and Safely
- Compresses Coil Springs on Most Passenger Cars and Pickup Trucks



Strut Spring Compressor

SKU 1207884 **49⁹⁹** REG. \$54.99
37036

OEM TOOLS

SAVE \$5

- Used to Compress Strut Springs During Cartridge Replacement
- Safety Latches Lock Spring in Place During Compression Hooks are Forged and Center Screw is Hardened for Longer Life
- Thread Length: 9"
- Can Be Used with Varying Coil Diameters Up to 5/8"



Offer Good While Supplies Last Through December 31, 2025

Suspension

OEM TOOLS

GM Upper Control Arm Knock Out Tool

SKU 420336 **24⁹⁹**
24210

- Services Chevrolet and GMC 1/2, 3/4 and 1 Ton, 2 and 4 Wheel Drive Trucks (1989 to 2001) and All Wheel Drive Chevrolet Astro and GMC Safari Vans (1990 to 2002)



Shock Socket

OEM TOOLS

Volvo Shock Retaining Nut Strut Removal Socket Tool

SKU 300125 **19⁹⁹**
24365

- Remove and Install Top Shock Retaining Nut on Volvo Models
- Applications Include: Volvo C70 (1999-2004), Volvo S40 (2000-2004), Volvo S60 (2001-2004), Volvo S70 Non-Turbo (1999-2000), Volvo S70 Turbo (1999-2000), Volvo S70 AWD Turbo (1999-2000), Volvo S80 (1999-2004), Volvo S80 V8 (2007-2008), Volvo S80 Turbo (1999-2006), Volvo V40 (2000-2004), Volvo V70 (1999-2007), Volvo XC90 (2003-2010)



Front End Service Kit

OEM TOOLS

5 Piece Front End Service Kit

SKU 1267952 **99⁹⁹**
26554

- Large and Small Pitman Arm Puller for Ball Joint Application
- Two Ball Joint Separators
- Three Tie Rod Pullers



Torsion Bar Tool

OEM TOOLS

GM, Ford, Chrysler Torsion Bar Tool

SKU 1103600 **64⁹⁹**
37278

- Safely Loads and Unloads 5-Lug, 6-Lug and 8-Lug GM, Dodge and Ford Torsion Bar Suspensions for Key Replacement
- Extended Long Reach "C-Clamp" for Use with 2011 and Higher GM Heavy Duty Trucks
- Includes Ford/Dodge Adapter



Prices subject to change without notice. Prices do not include applicable taxes, vehicles, tires, rims, installation or optional equipment as shown. Please do not return purchases to the store. For information regarding warranty, repair, or any questions or concerns, call 901-300-4878.

AZG0425

CHASSIS & SUSPENSION

Hub Bearing

Brake Drum and Rotor Puller

SKU **1125878** **159⁹⁹**
25106

- Use on Most FWD and AWD (Some RWD) Vehicles.
- Use with Impact Wrench to Remove Hubs, Drums and Brake Rotors
- Includes 3 Hub Adapters for Use with Most Common Hub Sizes and Types
- Jaw Spread Up to 14" with 5" Reach
- Durable Forged Frame Rated to 7 Tons of Pulling Force for the Toughest Jobs
- Drum and Rotor Pulling Arms Feature with Raised Stops for Use with Ratchet Straps (Not Included)
- Easily Adjust the Arms and Set Puller in Place for Tough Pulling Jobs in Tight Spaces

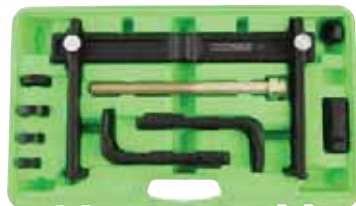

Master Wheel Hub and Bearing Remover and Installer Set

SKU **1103635** **399⁹⁹**
37342

- For Removal and Installation of Front Wheel Hub on Most Vehicles
- Self Centering Design is Incredibly Durable and Easy to Use
- Works on Front, Rear and All-Wheel Drive Vehicles
- Heavy Duty Thrust Bearing Reduces Effort and Extends the Life of the Pressure Screw
- Includes: Adapter Shoes, Pusher Washers, Receiver Sleeves, Nut-Bolt and Heavy Duty Bearing



OEM TOOLS®

Wheel Hub Removal Tool

SKU **1245618** **114⁹⁹**
25749

- Ideal For Removing a Frozen Hub Assembly without Damaging the Axle
- For Use on Many Axle Bolted Hubs Including Five, Six and Eight Lug Hubs
- Constructed from High-Quality, Impact-Resistant and Corrosion-Resistant Steel
- 2-5/8" Center to Center Hole Pattern
- 3/4" Steel Backing Plate and Reinforced Striking Plate for Long Life



Front Wheel Drive Hub Puller

SKU **02050** **27⁹⁹**
27037

- Fits Most Domestic and Import Vehicles
- Yoke and Bolt are Threaded 5/8" x 18
- Heat-Treated Pressure Screw for Toughness



Slide Hammer Not Included

Tie Rod Tools

Master Inner Tie Rod Tool Set

SKU **344979** **79⁹⁹** **SAVE \$20**
27178 REG. \$99.99

- Works on Both Small Cars and SUVs
- Tube Handle Has an Inner Diameter of 2.125" to Service Small Cars, Pickups and Large SUVs
- Includes 12 Crowfoot Style Adapters, Sizes: 29 mm, 1-3/16", 1-1/4", 32.5 mm, 1-5/16", 33.6 mm, 1-3/8", 1-7/16", 1-1/2", 38.4 mm, 40 mm and 42 mm



Offer Good Through December 31, 2025

OEM TOOLS®

Tie Rod End Remover

SKU **209525** **29⁹⁹**
27175

- Comes with Pressure Screw Tip Swivels for Damage Free Results
- Will Not Damage Tie Rod End Dust Boot
- Rust Resistant Finish



OEM TOOLS®

Inner Tie Rod Tool Kit

SKU **217377** **54⁹⁹**
27185

- Removes and Installs Tie Rod End on Rack and Pinion Steering
- Includes: 3/16", 5/16" and 7/16" Adapters



OEM TOOLS®

Inner Tie Rod Tool

SKU **291414** **119⁹⁹**
LIS45750

- 6 Sizes: 1-3/16", 1-1/4", 1-5/16", 1-7/16", 1-1/2" and 33.6 mm



Lisle

Pitman Arm Puller

Pitman Arm Puller for Light Trucks

SKU **OSB** **54⁹⁹**
27170

- Services Cars and Light Trucks 3/4 Ton
- Features Forged Adjustable Jaws and Two Clamp Bolts That Lock Jaws Together
- Pressure Screw Has Ball Head Designed for Striking



For OSB, Call 901-300-4878

OEM TOOLS®

Pickle Forks

Stepped Pickle Fork Set

SKU **291410** **79⁹⁹**
LIS41400

- 6 Tools in One
- Includes: 11/16", 15/16", 1-1/8" Forks and 2 Handles



Lisle

5 Piece Tie Rod and Ball Joint Set

SKU **1103626** **49⁹⁹** **SAVE \$20**
37201 REG. \$69.99

- Used to Remove Tie Rods and Ball Joints
- Includes: 11" x 1-1/8", 11-3/4" x 1-5/8", 11-5/8" x 1-7/16", 16" x 11/16" and 16" x 15/16"



OEM TOOLS®

Offer Good Through December 31, 2025

CHASSIS & SUSPENSION

TO ORDER, contact your Commercial Sales Manager or go to AutoZonePro.com

CHASSIS & SUSPENSION

CV Axle Nut Sockets

12 Pt. 39 mm Axle Nut Socket
SKU 824759 27321H

29⁹⁹

- Replacement Part for OEMTOOLS 27321 8 Piece Axle Nut Socket Set (12 Pt.)



Axle Nut Socket Sets

OEMTOOLS®

- Includes Sizes: 29, 30, 32, 34, 35, 36, 38 and 39 mm

89⁹⁹

6 Pt.
SKU 1103577 37320



12 Pt.
SKU 1103460 37321



See AZTOOL1.com for Full Line of CV Axle Nut Sockets

Bushing Tool Set

OEMTOOLS®

Manual Bushing Installation and Removal Tool Set
SKU 298214 27212

299⁹⁹

- Comprehensive Kit for Fast and Effective Removal/Installation of Wheel Bearings/Suspension Bushings and Seals
- Allows the Technician to Service a Wide Range of Bushings without Removing Components from the Vehicle
- Comes with 20 Sleeves for Hundreds of Combinations
- External Sleeve Diameter: 44, 46, 48, 50, 52, 54, 56, 58, 60, 62, 64, 66, 68, 70, 72, 74, 76, 78, 80 and 82 mm

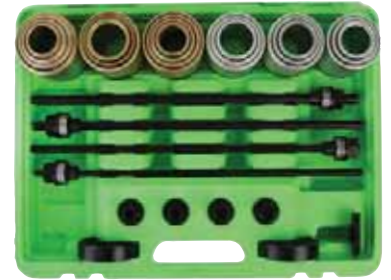

Axle Tools

CV Axle Puller Adapter
SKU 02061 27058

19⁹⁹

- Works with OEMTOOLS 37033, 37191, 27085, 27033 and Other Slide Hammer Pullers with 5/8" x 18 Threads



CV Axle Popper Set
SKU 1189082 37305

34⁹⁹

- Includes: Axle Shim Tool and Fork/Wedge Tool
- Length: 13-3/4"
- Used to Remove Axles from the Transmission, Ball Joints in the Suspension System and Tie Rods
- Fork Design Allows Mechanic to Exert Force Evenly on Both Sides of the Axle



5 Lb. Slide Hammer
SKU 1103572 37033

54⁹⁹

- Use to Pull Bushings, Seals, Sleeves, Bearings, Flange-Type Rear Axles, Front-Wheel Drive Hubs, Dents and Pressed-In Bolts with Two or Three Jaw Puller Options
- Slide Rod is 3/4" x 16 Standard Threads



4WD Spindle Puller
SKU 143436 27104

44⁹⁹

- Use with OEMTOOLS Slide Hammer 27033
- Fits Most Spindles 1-1/2", 1-5/8" and 2" on 4 Wheel Drive Vehicles
- Heat-Treated for Strength
- Will Fit on 2 Puller Size Shafts 1/2" x 20 Threads and 5/8" x 18 Threads



Rear Axle Puller Set
SKU 094801 27202

114⁹⁹

- Use for Flange-Type Rear Axle and Bearing Removal on Most Late Model Passenger Cars and Light Trucks
- Slide Rod and Adapters are 5/8" x 18 Standard Threads



Axle Spindle Threading Set
SKU 1103645 37233

49⁹⁹ REG. \$84.99

- Use to Clean or Repair Axle Threads
- Set Comes with a Special Twist Shape That Provides Easier and Quicker Work
- Sizes Included: M20 x 1.25, M20 x 1.50, M22 x 1.00, M22 x 1.50, M24 x 1.50, M24 x 2.00, 13/16" x 20 UNEF, 3/4" x 20 UNEF and 27 mm Extension Bar

SAVE \$35



Offer Good While Supplies Last Through December 31, 2025

Seal Tools

Transmission/Transaxle Plugs
SKU 298196 24490

14⁹⁹

- Includes 5 Plugs to Seal Both Transmissions and Transaxles on Most Import and Domestic Vehicles
- Stepped Design for Retention and Positive Sealing
- Includes Side Gear Centering Pin for Ford Transaxles



Bearing Race and Seal Master Driver Set

SKU 1103639 37119

34⁹⁹ REG. \$49.99

- Installs Most Standard Wheel Bearings and Races
- Includes Driver Sizes: 1.565", 1.750", 1.965", 2.325", 2.470", 2.555", 2.830", 2.995", 3.180" and Handle

SAVE \$15



Offer Good While Supplies Last Through December 31, 2025

Seal Puller

SKU OSB 25014

14⁹⁹

- 2 Tops Fit All Seal Sizes
- Pops the Seal Out Every Time
- No Pounding or Hammering
- Protects Bearings and Races
- Rubber Handle



For OSB, Call 901-300-4878

Prices subject to change without notice. Prices do not include applicable taxes, vehicles, tires, rims, installation or optional equipment as shown. Please do not return purchases to the store. For information regarding warranty, repair, or any questions or concerns, call 901-300-4878.

CHASSIS & SUSPENSION

Power Steering Bleeders

Vacuum Pump Tester, Power Steering and Brake Bleeder Set
SKU 1103570 **49⁹⁹**
37070

- Includes: Vacuum Pump Reservoir Jar with Transfer Lid, Storage Lid, Brake Bleeding Adapter Package, Steering Pump Adapters and Tubing



Power Steering Bleeder Set
SKU 434716 **29⁹⁹**
27311

Reduce Comebacks

- Eliminate Trapped Air in Power Steering and Brake Systems Following Repairs or Fluid Changes
- Includes: 2 EPDM Tapered Rubber Adapters to Fit Most Power Steering Pumps and Reservoirs, Reservoir Bottle to Protect Hand Vacuum Pumps and 3 Sizes of Brake Bleeder Adapters
- Works with a Hand Vacuum Pump



Drive Line Tool

1/2" Drive (12 mm) Ford Drive Line Impact Socket
SKU 420319 **24⁹⁹**
24212

- Applications Include Many Ford Drive Line Bolts
- 12 mm, 12 Pt.



Power Steering Pullers

Power Steering Pulley Remover/Installer - Ford, GM, Chrysler
SKU 1103578 **34⁹⁹**
37031

- Includes 2 Screws for Use on Most Ford, Chrysler, GM and VW Power Steering Pulleys
- Pulls Pulleys on GM Belt Driven Vacuum Pumps and Pressed-On Water Pump Pulleys of GM V6 Engines



Steering Wheel Puller
SKU 1103540 **44⁹⁹**
37182

- Designed for All Major Makes and Models
- Sizes Included: 1/4" x 28, 8 mm x 1.25, 5/16" x 18, 5/16" x 24, and 3/8" x 16

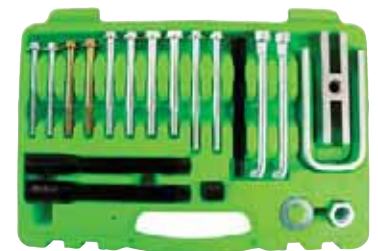

U-Joint Tools

U-Joint Pullers

- Easily Removes Seized U-Joint Cups on Most Passenger Vehicles and Light Duty Trucks
- Does Not Damage the Driveshaft, Yokes, Joints or Bearing Cups

Automotive
SKU 949561 **89⁹⁹**
24539

- Bearing Cup Outside Diameter: 1" to 1.25"

Intermediate
SKU 949565 **99⁹⁹**
24548

- Bearing Cup Outside Diameter: 1.25" to 1.7"

Heavy Duty
SKU 041474 **134⁹⁹**
24538

- Bearing Cup Outside Diameter: 1.5" to 2.2"



Automotive Bearing Cup Installer
SKU 949571 **59⁹⁹**
24549

- For the Installation of Bearing Cups on Light-Duty and Medium-Duty U-Joints
- Efficiently Install 2 Bearing Cups in One Process
- Contact Points Feature Magnets to Retain Bearing Cups During Operation



Spindle Nuts

GM Axle Hub Nut Socket
SKU 298219 **29⁹⁹**
25967

- Applications: GMT900 Silverado, Sierra HDCS, 2-Wheel (2WD) and 4-Wheel (4WD) Drive Cheyenne, Silverado, Escalade, Sierra and Avalanche Trucks with 10.5" or 11.5" Ring Gear
- Has 9 Pins to Fit GM Style Retaining Nuts
- Unapproved Methods Can Damage the Bearing or Result in Shorter Service Life



Dodge Hub Locknut Socket
SKU 344964 **14⁹⁹**
25968

- Fits Dodge 1/2-Ton Pickup Trucks (1994-Newer) with Dana 44 Front Axle and Dana 60 Axle with a Vacuum Disconnect
- Designed to Accommodate the 1-11/16" (43 mm) Wheel Bearing Retaining Nut Which is Recessed into the Hub



Toyota 4 Pin Hub Locknut Socket
SKU 298224 **14⁹⁹**
25969

- Serves High Torque Locknuts on Toyota 4WD Vehicles Having Free Wheel (Lock Out) Hubs
- Tacoma (1995-Newer); T100 and 4Runner (1996-Newer)
- Improved Design with Solid Pins for Increased Durability



Ford Rear Axle Nut Wrench
SKU 1392337 **24⁹⁹**
27353

- Serves 2003-Newer Ford F-250, F-350 and F-450 Super Duty Trucks with 10-1/2" Rear Axle
- Same as Ford Part Number 205-448
- Use with a 1/2" Drive Ratchet or Breaker Bar



1/2" Drive Socket Bearing Locknut
SKU 231203 **14⁹⁹**
25243

- Fits Adjusting Nuts Found on Ford F150 Trucks (1995 to 1996) and Full Sized Broncos with Automatic Locking Hubs



4WD Ford Spindle Socket, 66.5 mm x 80 mm
SKU 603346 **19⁹⁹**
25965

- Fits Ford F-Series 1/2-Ton Truck and Full-Size Bronco with Manual Hubs; 1995-Newer Ford F-Series 3/4-Ton and 1-Ton Trucks with Manual Hubs; 1959-85 Ford F-Series 1/2- and 3/4-Ton Trucks and Full-Size Bronco; 1960-90 GM 1/2-Ton Truck and Full-Size Blazer/Jimmy; 1969-89 Dodge 1/2-Ton Truck with Manual Hubs; 1969-72 International 1/2-Ton Truck
- 1/2" Sq. Drive



4WD Ford - Dodge Spindle Socket, 76 mm x 80 mm
SKU 603347 **19⁹⁹**
25966

Toyota 8 Pin Front Hub Locknut Socket
SKU 298205 **29⁹⁹**
25962

- Allows for Easy Removal and Installation of Front Hub Lock Nut without Damage to the Nut
- Applications: Toyota 4Runner 2WD (2007 to 2014), Toyota Sequoia (2008 to 2014), Toyota Tundra (2007 to 2014)
- 3/4" Drive



AIR CONDITIONING

TO ORDER, contact your Commercial Sales Manager or go to AutoZonePro.com

AIR CONDITIONING

FOR MORE DETAILS ON RECOVERY MACHINES GO TO AZTOOL1.COM

Recovery Machines

ArcticPRO®



MSSACX2180

Warranty:
2 Years Parts and 1 Year Labor

MAHLE	Refrigerant 134a			Refrigerant 1234yf	
	ACX-2150 R134a Recovery Machine SKU 213170 MSSACX2150	ACX-2180 R134a Recovery Machine SKU 213168 MSSACX2180	ACX-2180H R134a Hybrid Recovery Machine SKU 213203 MSSACX2180H	ACX-2250 R1234yf Recovery Machine SKU 213151 MSSACX2250	ACX-2280 R1234yf Recovery Machine SKU 1187032 MSSACX2280
Automatic Oil Drain	✓	✓	✓	✓	✓
Automatic Air Purge	✓	✓	✓	✓	✓
Included Database	Optional	✓	✓	Optional	✓
Automatic Oil and Dye Injection	✓	✓			
Includes Refrigerant Identifier				✓**	✓*
Phone Application	Optional	✓	✓	Optional	✓
<i>Price</i>	<i>4,399⁹⁹</i>	<i>5,099⁹⁹</i>	<i>5,099⁹⁹</i>	<i>6,349⁹⁹</i>	<i>7,249⁹⁹</i>

On-Board Integrated Thermal Printer (Optional) *Integrated **Non-Integrated

ECOTECHNICS



Training Videos



HOFEAC800

Warranty:
1 Year Parts and Labor

Description	Hybrid Ready R134a SKU 1339733 HOFEAC820B	Hybrid Ready R1234yf SKU 1335790 HOFEAC830B	Eco Dual Gas A/C Service Station SKU 1335792 HOFEAC800
Refrigerant Type	R134a	HFO-1234yf	R134a + HFO1234yf
Refrigerant Tank	30 Lb.	30 Lb.	30 Lb. + 30 Lb.
Command Valves	Automatic	Automatic	Automatic
Display	5" Touch	5" Touch	7" Touch
Database	✓	✓	✓
Printer	✓	✓	✓
Status Light	✓	✓	✓
Hybrid Function	✓	✓	✓
<i>Price</i>	<i>5,249⁹⁹</i>	<i>6,799⁹⁹</i>	<i>10,499⁹⁹</i>

KONFORT



TEXA17810

Warranty:
2 Years Parts and Labor

TEXA	750R R134a Recovery Machine SKU 1282745 TEXZ11450	760 R1234yf Recovery Machine SKU 1282756 TEXA17910	780 Dual Gas Recovery Machine SKU 1282809 TEXA17810
Automatic Oil Drain	✓	✓	✓
Automatic Oil and Dye Injection	✓		
10 in. Multi-Touch Display		✓	✓
R134a Management	✓		✓
R1234yf Management		✓	✓
Vehicle Capacity Database	✓	✓	✓
Software Update Over Wi-Fi		✓	✓
Push-Pull Recovery	✓	✓	✓
Fully Automatic Operation	✓	✓	✓
<i>Price</i>	<i>5,399⁹⁹</i>	<i>8,749⁹⁹</i>	<i>10,549⁹⁹</i>

Prices subject to change without notice. Prices do not include applicable taxes, vehicles, tires, rims, installation or optional equipment as shown. Please do not return purchases to the store. For information regarding warranty, repair, or any questions or concerns, call 901-300-4878.

AIR CONDITIONING

Recovery Machines

ROBINAIR



ROBAC1234-9

Warranty:
1 Year Parts and Labor

Description	AC1234-4 Premier R1234yf SKU 1212384 ROBAC1234-4	AC1234-9 Connected R1234yf ACS SKU 1212383 ROBAC1234-9	34288NI Economy R134a SKU 221185 ROB34288NI	34788NI-H Premier R134a Refrigerant for Hybrid and Non-Hybrid Vehicles SKU 751572 ROB34788NI-H	34788NI Premier R134a Refrigerant SKU 751569 ROB34788NI	34998 Connected R134a ACS SKU 1212385 ROB34998
Operation	Automatic	Automatic	Semi-Automatic	• Automatic • Hybrid Vehicle Applications	• Automatic • Auto Oil Injection	• Automatic • Auto Oil Injection
Display	4.3" LCD Display	10" Hi-Res Touch Screen	4.3" Full Color Display	4.3" Full Color Display	4.3" Full Color Display	10" Hi-Res Touch Screen
Printer	ROB30038 (optional)	Wireless Printing	ROB30038 (optional)	ROB30038 (optional)	ROB30038 (optional)	Wireless Printing
Bluetooth and Wi-Fi		✓				✓
Price	6,395⁹⁹	7,449⁹⁹	4,099⁹⁹	4,899⁹⁹	4,899⁹⁹	5,999⁹⁹

MSX



CPSMSX3030

Warranty:
2 Years Parts and Labor

cps	R134a SKU 1407803 CPSMSX134	R1234yf SKU 1407806 CPSMSX1234	R134a/R1234yf SKU 1407510 CPSMSX3030	Heavy Duty R134a SKU 1407805 CPSMXHD
Fully Automatic	✓	✓	✓	✓
Onboard Oil Injection	✓			
High Capacity Oil-less Compressor	✓	✓	✓	✓
Vehicle Database Included	✓	✓	✓	✓
10 Ft. Service Hoses	✓	✓	✓	18' Hose
Includes 2 Tanks and 2 Sets of Hoses			✓	
Wi-Fi and Bluetooth Enabled	✓	✓	✓	✓
Touch Screen	7" Hi-Res	7" Hi-Res	7" Hi-Res	7" Hi-Res
Includes Refrigerant Identifier		✓	✓	
Converts Between R134a and R1234yf in 10 Min.			✓	
Price	5,399⁹⁹	6,999⁹⁹	9,299⁹⁹	7,649⁹⁹

Recovery Machine Filters/Maintenance Kits

ROBINAIR

cps

Mastercool
"World Class Quality"

MAHLE

ECOTECHNICS

SKU	Part Number	Brand	Fits	Price
522875	ROB34430	Robinair	17700A, 34450, 34700, 34134Z	133.99
414883	ROB34724	Robinair	34288, 34788, 34788NI, 34788NI-H, 34988, 347002, 34134Z	89.99
752703	ROB13172	Robinair	Maintenance Kit for Models Using 34724 Filter - Includes Oil	159.99
186483	CPSARXF5	CPS	FX and AR Series CPS Equipment	99.99
1149172	CPSFX3030X1	CPS	Includes FX Series Filter, Vacuum Pump Oil and Coupler O-Rings for FX134A	154.99
389222	MSC69788FLTPK	Mastercool	69788, 69789 and 69789-H	249.99
199681	MSCCOM1FLTRPK	Mastercool	Commander 4000 and 4000x	184.99
199675	MSCCOM2FLTRPK	Mastercool	Commander 1000, 2000 and 3000	229.99
1149182	MSS3608325400	Mahle	ACX2180, ACX2180H and ACX2280	119.99
207349	MSS268077600	Mahle	ACX1120H, ACX1150, ACX1150H and ACX2120H	119.99
207508	MSS3608273900	Mahle	ACX1280, ACX2150 and ACX2250	114.99
818739	RTI3608213300	Mahle	RHS980 and ACX1180	119.99
1406968	HOFEEAC33023B	EcoTechnics	HOFEEAC800, HOFEEAC810, HOFEEAC820B, HOFEEAC830B	99.99

Prices subject to change without notice. Prices do not include applicable taxes, vehicles, tires, rims, installation or optional equipment as shown. Please do not return purchases to the store. For information regarding warranty, repair, or any questions or concerns, call 901-300-4878.

A/C VACUUM PUMP KITS - BETTER VALUE FOR YOUR MONEY

Starter A/C Vacuum Pump Kit - R134a

SKU **1400034**
68950

- Includes: 1.8 CFM, 100 Micron Single Stage Vacuum, Professional Quality Extruded Aluminum Manifold with 72" Hoses, High Quality Manual Couplers and R134a Can Tap



249⁹⁹
REG. \$299.97

SAVE **\$49**
OVER
When You Buy the Kit

R134a and R1234yf Spark-Free A/C Vacuum Pump Kit

SKU **1400036**
68951

- Includes: 6 CFM, 75 Micron, Spark-Free Single Stage Vacuum for Use with R134a or R1234yf, Extruded Aluminum Manifold Gauges, 72" Hoses with High Quality Manual Couplers, R1234yf Conversion Couplers That Convert R134a Manifold and Hoses to R1234yf, 1/2" ACME Right Hand to 1/2" ACME Left Hand Tank Adapter, 1/4" SAE x 1/2" ACME Hose to Vacuum Pump Adapter and R134a and R1234yf Can Tap



349⁹⁹
REG. \$404.98

SAVE **\$54**
OVER
When You Buy the Kit

Electronic Leak Detection

A/C Refrigerant Leak Detector

SKU **466307** **99⁹⁹**
24510

Detects All Types of Halogenated Refrigerants

- Sensitive to 0.1 Oz. per Year Single Color LED Display with 7 Level Leak Alarm
- Flexible Stainless Steel Probe to Reach Almost Any Space
- Includes Spare Sensor Tip
- Works with 1234yf



Black Series Infrared Refrigerant Leak Detector

SKU **OSB** **549⁹⁹**
MSC55600-A

- Easily Select Sensitivity Levels with a Maximum Sensitivity Up to 0.14 Oz./Yr.
- TFT Screen Provides Clear and Easy Readings That Show Leakage, Sensitivity, Battery Level and Sensor Fault Indicators
- Designed to Meet EN14624, SAE1627, SAE2791 and SAE2913 Standards



Raptor Refrigerant Leak Detector

SKU **916550** **274⁹⁹**
MSC56100

- Features 3 Sensitivity Levels and 5 Detection Levels
- Detects Leaks as Small as 1/10 Oz. per Year
- Detects All Refrigerants (CFC, HCFC, HFC)
- Flexible 16" Probe for Hard-to-Reach Areas
- Works with 1234yf



Inspector 2-in-1 Electronic/UV Leak Detector

SKU **916553** **299⁹⁹**
MSC56200

- Pinpoint Leaks as Small as 1/10 Oz. (3 gr) Per Year
- Built-In Ultra-Bright UV Light at End of Probe - Allowing Easy Access into Tight Areas
- Works with 1234yf



Portable Recovery Systems

R-134 Twin Turbo Complete Recovery Machine

SKU **OSB** **1,999⁹⁹**
MSC69360

- Largest Volume Recovery Rate on the Market
- For Use with All Refrigerants Including R410A
- Injection Molded High Density Polyethylene Case for Maximum Durability
- Safety High Pressure Switch
- Revolutionary Double Piston Oil-Less Compressor



R1234yf Twin Turbo Complete Recovery Machine

SKU **OSB** **1,999⁹⁹**
MSC69360-YF

- Revolutionary Double Piston Oil-Less Compressor
- Largest Volume Recovery Rate on the Market
- Includes: 30 Lb. DOT Tank, Sight Glass, R1234yf Low Side Coupler, Oil Drain Bottle and R1234yf Blue and Yellow Hoses



R134a/R1234yf Complete A/C Recovery Set

SKU **OSB** **2,179⁹⁹**
MSC69372

- Built with the Safest Spark-Free Components
- Includes All Hoses and Couplers Needed to Recover, Cleanse and Remove the Oil from R134a and R1234yf Automotive A/C Systems
- 30 Lb. DOT Tank for R134a and 30 Lb. DOT Tank for R1234yf Refrigerants Included with Each Unit (Refrigerant Sold Separately)
- 115V/60 Hz
- 1/2 HP Oil-Less Compressor
- Compatible Refrigerants: All CFCs, HCFCs and HFCs



To Confirm Price, Availability and Ordering Instructions on OSB, Call 901-300-4878

Prices subject to change without notice. Prices do not include applicable taxes, vehicles, tires, rims, installation or optional equipment as shown. Please do not return purchases to the store. For information regarding warranty, repair, or any questions or concerns, call 901-300-4878.

AIR CONDITIONING

Vacuum Pumps

1.8 CFM Single Stage Vacuum Pump

SKU 466312 **129⁹⁹**
24500

- Motor: 1/4 HP, 110V
- Ultimate Vacuum Rating: 100 Microns
- Inlet Ports: 1/2" ACME - 1/4" Flare
- Oil Capacity: 6.7 Oz. (200 mL), Included
- Internal High Volume Cooling Fan for Extended Use



4 CFM Single Stage Vacuum Pump

SKU 466305 **139⁹⁹**
24501

- Motor: 1/3 HP, 110V
- 75 Microns
- Inlet Ports: 1/2" ACME 1/4" Flare
- Oil Capacity: 11 Oz. (330 mL), Included
- Internal High Volume Cooling Fan for Extended Use



6 CFM Single Stage Vacuum Pump

SKU 466306 **164⁹⁹**
24502

- Motor: 1/2 HP, 110V
- 75 Microns
- Inlet Ports: 1/2" ACME - 1/4" Flare
- Oil Capacity: 11 Oz. (330 mL), Included
- Internal High Volume Cooling Fan for Extended Use



6 CFM Spark-Free Vacuum Pump

SKU 213133 **259⁹⁹**
24642

- Motor: Spark-Free 1/2 HP, 110V
- Ultimate Vacuum Rating: 75 Microns
- 3 Inlet Ports: 1/4" Flare, 1/2" ACME and 1/2" ACME LH
- Oil Capacity: 330 mL, Included
- Internal High Volume Cooling Fan for Extended Use
- Can Be Used with R1234yf Refrigerant



Black Series 1.8 CFM Single Stage Vacuum Pump

SKU 1414397 **184⁹⁹**
MSC90059-BL

- 80 Microns
- 1/4 HP
- 110/120, 60 Hz
- T-Fitting 1/4" FL-M x 1/2 ACME-M



1.8 CFM Deep Vacuum Pump

SKU 1330695 **219⁹⁹**
MSC290059RCL

- 1.8 CFM Deep Vacuum Pump
- 1/4" and 1/2" Fittings
- For Use with Multiple Refrigerants



3 CFM Single Stage Vacuum Pump

SKU 1392324 **239⁹⁹**
MSC290062

- Large Fan Keeps Vacuum Pump Cooler and Extends Life
- 1/4" SAE and 1/2" ACME Port Access
- 110-120V, 60 Hz Voltage



6 CFM 2 Stage Vacuum Pump

SKU OSB **449⁹⁹**
MSC900662V-BL

- 15 Microns
- 1/2 HP
- 110/220, 50/60 Hz
- Includes: 3 Inlet Ports: 1/4", 3/8" SAE and 1/2" ACME

For OSB, Call
901-300-4878



Spark-Free 6 CFM Vacuum Pump (Single Stage)

SKU 1400035 **349⁹⁹**
MSC90066BLSF

- 80 Microns
- 1/3 HP
- 110/120V, 60HZ
- T-Fitting 1/4" FL-M x 1/2 ACME-M



Air-Operated Vacuum Pump

SKU 544730 **44⁹⁹**
24533

- Includes: 1/2" ACME (R134a) and R12 Connectors
- Air Pressure Range: 75 to 180 psi
- Air Consumption: 4.2 CFM @ 90 psi
- Vacuum Capacity: 28.3" of Mercury @ 90 psi



Vacuum Pump Oil (8 Oz.)

SKU 363429 **10⁰⁰**
24399

- Increases Life Span of the Pump
- Performance of Your Pump Depends on Regular Service and the Quality and Purity of the Vacuum Pump Oil That You Use
- Compatible for Use in Pumps Made by Most Manufacturers



Premium Vacuum Pump Oil 1 Quart Bottle

SKU 517580 **19⁹⁹**
CPSVPOQ12

- Compatible with Most Pumps
- Increases Life Span of the Pump
- Performance of Your Pump Depends on Regular Service and the Quality and Purity of the Vacuum Pump Oil That You Use



STORE STOCKED

Prices subject to change without notice. Prices do not include applicable taxes, vehicles, tires, rims, installation or optional equipment as shown. Please do not return purchases to the store. For information regarding warranty, repair, or any questions or concerns, call 901-300-4878.

Manifold Gauges

R1234yf Manifold Gauge and Hose Set

SKU 752518 **149⁹⁹**
24559

- 3" Easy-to-Read Gauges with Temperature Chart
- 72" Hoses
- High Quality 6-Ball Manual Couplers



OEM TOOLS®

Dual Aluminum R134a/R1234yf Gauge Set

SKU 1335797 **199⁹⁹**
25130

- Includes: 72" Hoses, Manual Couplers and Can Tap Valves with 1/2" ACME Fittings for Use with Both R134a and R1234yf Refrigerants

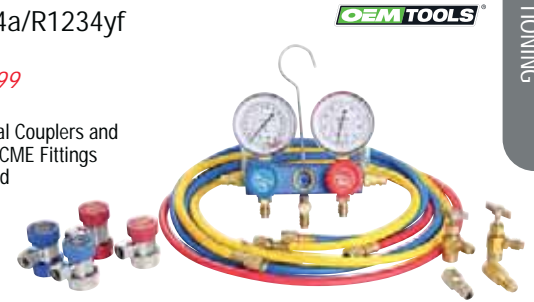

OEM TOOLS®

R134a Brass Manifold Gauge Set

SKU 752520 **74⁹⁹**
24563

- High Quality Brass Body with Sight Glass
- Large 2-1/2" Gauges are Easy to Calibrate and Have a High Impact Lexan Lens
- 60" Hoses (3,000 psi Burst, 600 psi Working Pressure)
- Snap Style Quick Couplers

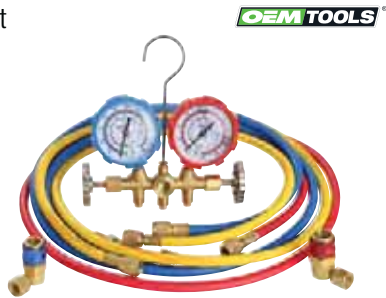

OEM TOOLS®

R134a Manifold Gauge and Hose Set

SKU 466319 **159⁹⁹**
24527

- Easy-to-Read 2-3/4" Spring Dampened Gauges to Reduce Flutter
- Extruded Aluminum Manifold
- 72" Hoses with Manual Couplers



OEM TOOLS®

Deluxe R134a Gauge Set

SKU 1282751 **144⁹⁹**
MSC289772CL

- Solid Block Extruded Aluminum Manifold
- 72" Long Hoses with Manual Couplers
- Gauge Guards for Protection

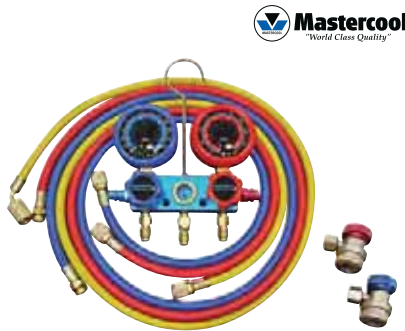

Mastercool®
"World Class Quality"

Dual R134a, R-12 Manifold Gauge Set

SKU 1335804 **169⁹⁹**
MSC293996PBCL

- Solid Block Extruded Aluminum Manifold
- 96" Long Hoses with Manual Couplers
- Gauge Guards for Protection
- Silicone Dampened Calibratable Gauges
- Extra Long Hose for Access to Heavy Duty Buses, Fleet and Refrigerated Trucks Systems



Mastercool®
"World Class Quality"

R134a Aluminum Manifold Kit with Dye Injector

SKU 290023 **174⁹⁹**
MSC89660UV

- Includes: R134a Aluminum Manifold, 60" Hoses, Standard Couplers and 10 Application Mini Dye Injector



Mastercool®
"World Class Quality"

Dual R134a/R1234yf Brass Gauge Set

SKU 1142631 **184⁹⁹**
MSC66661AYF

- 2-1/2" Silicone Dampened, Recalibrateable Gauges
- Extra Access Port for Vacuum Line
- R1234yf High and Low Side Quick Couplers
- R134a High and Low Side Economy Couplers
- 1/2" ACME-M x 1/2" ACME-F LH Thread Adapter
- (2) 12 mm-M x 14 mm-F R1234yf Adapters
- Set of 3 - R134a Standard Hoses



Mastercool®
"World Class Quality"

R1234yf Aluminum Manifold Gauge Set

SKU 505065 **274⁹⁹**
MSC83272

- Ideal for Shops That Want to Wait to Invest in New AC Service Stations Adapted for R1234yf
- Contains Manifold, 3 Service Hoses, 2 Service Couplers LT/HT



Mastercool®
"World Class Quality"

Dual Aluminum R134a/R1234yf Gauge Set

SKU 1086254 **299⁹⁹**
MSC89661AYF

- Professional Extruded Aluminum Block
- 2-1/2" Silicone Dampened, Re-Calibrateable Gauges
- Free-Floating Piston Type Valves Reduce O-Ring Wear
- R1234yf High and Low Side Couplers with Extended Disconnect Protection Sleeve
- Standard Hoses, R134a Manual Couplers, R1234yf Couplers, 1/2" ACME-M x 1/2" ACME-F LH Thread Adapter, (2) 12 mm-M x 14 mm-F R1234yf Adapters



Mastercool®
"World Class Quality"

AIR CONDITIONING

Can Taps

R1234yf
Self-Sealing Can Tap
SKU 213178
24553 **9⁹⁹**

R134a
Can Tap
SKU 466315
24524 **9⁹⁹**



4-Way Side Can Tap
SKU 1103203
FJC6842 **34⁹⁹**

- For Use with R-12, R134a or R1234yf Refrigerant Cans and Oil Change Cans
- Fits Cans with 2-7/8", 2-1/2" and 2" Diameter
- Includes: 1/2" ACME LH, 1/2" ACME and 1/4" Flare Male Fitting with Check Valve



Refrigerant and Oil Charge Side Can Tap
SKU 466313
24523 **24⁹⁹**

- Fits 1 Lb. Cans of R134a, R12 and 2" Oil Charge Cans
- Plier Type Grip with Positive Lock
- Includes: 1/2" ACME Male and 1/4" FL Male Ports with Safety Valve



3-In-1 Side Mount Can Tap
SKU 290033
MSC85530 **19⁹⁹**

- Unique Design will Work on All R134a (2-7/8"), R12 (2-1/2") and Oil Charge (2") Cans
- Outlet Port Offers a 1/2" ACME and 1/2" FL Fitting with an Internal Check Valve to Prevent System Backflow



Manifold Gauge Repair

Replacement Gauge High Side for A/C Manifold
SKU 481705
24530 **19⁹⁹**

- Replacement High Side Gauge Fits OEMTOOLS® and Other Brands of A/C Manifolds Used to Service A/C Systems on Cars
- 1/8" NPTF Male Threads
- Reads 0 to 500 psi



Replacement Gauge Low Side for A/C Manifold
SKU 481709
24531 **19⁹⁹**

- Reads 0 to 120 psi and 0 to 30" Hg



A/C Manifold Upgrade Kit
SKU 1043688
68903

- Includes: 3-in-1 Side Mount Can Tap Valve, R134a Manual Coupler Set, 1234yf Self Sealing Can Tap, 1/2" ACME Hose Set 72", R134a to HFO-1234YF Conversion Coupler Set

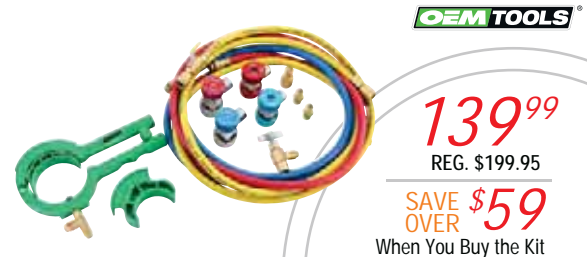

139⁹⁹
REG. \$199.95

SAVE OVER **\$59**
When You Buy the Kit

R1234yf Manifold/Hose Adapter Assortment
SKU 1142732
25091 **29⁹⁹**

- 6 Common Adapters to Fit Manifolds, Hoses, Couplers and Vacuum Pumps
- Includes: 1/2" LH ACME Female x 1/4" Male Flare, 1/2" ACME Male x M12 x 1.5 Male, 1/2" ACME Female x M12 x 1.5 Female, 1/4" Male Flare x M12 x 1.5 Male, 1/2" LH ACME Female x M14 ODK, 1/2" LH ACME Male x 1/4" Female Flare
- Includes Organizer Case with I.D. Labels



R134a/R12 Charging Hose Repair Kit
SKU 295557
MSC91334-A **34⁹⁹**

- 50 Piece Assortment of Replacement Gaskets, O-Rings, Depressors for Charging Hoses and Adapters



72 Pc. Valve and Gasket Set
SKU 1544670
25099 **14⁹⁹**

- Includes: 50 Common Gaskets for 134a Hoses and Manifold Sets, 10 Replacement Valves and 10 Replacement Valve Cores
- Includes: Valve Core Replacement and Installation Tool and Organizer Case



A/C Hoses

96" R134a Red Hose
SKU 489152
MSC84963 **49⁹⁹**

- 1/2" ACME-F and 14 mm-M Auto A/C Fittings - 96"



96" R134a Blue Hose
SKU 489151
MSC84961 **49⁹⁹**

- 1/2" ACME-F and 14 mm-M Auto A/C Fittings - 96"



72" R134a Hose Set
SKU 752516
24558 **49⁹⁹**

- 3 Color Coded Hose: Red, Yellow and Blue



96" 2 Pc. 1234yf Recovery Hose Set
SKU 85829
25010 **29⁹⁹**

- Includes 96" Set Blue/Red 12 mm-M x 12 mm-M
- Meets or Exceeds SAE J2888 Standards

72" 1/4" SAE Hose Set
SKU 752515
24557 **29⁹⁹**

- 3 Color Coded Hose: Red, Yellow and Blue



72" R1234yf Hoses
SKU 85803
25009 **34⁹⁹**

- Includes: (2) 72" High/Low Charging Hoses with 12 mm Male Fittings and 72" Charging Hose with 12 mm and 1/2" x 16" Left Hand Acme Fitting
- Meets or Exceeds SAE J2888 Standards



AIR CONDITIONING

TO ORDER, contact your Commercial Sales Manager or go to AutoZonePro.com

AIR CONDITIONING

A/C Service Tools

A/C Condenser Fin Comb Straightener/Cleaner

SKU 466317 **12⁹⁹**
24526

- Clean and Straighten Condenser and Evaporator Coils
- Compact Design for Confined Spaces
- 6 Clearly Marked Combs: 8, 9, 10, 12, 14 and 15 Fins per Inch



Valve Core Tool Set (2 Piece)

SKU 1209377 **12⁹⁹**
22589

- Designed for Removal and Installation of Schrader Style Valve Cores



A/C Clutch Holding Tool

SKU 1392339 **19⁹⁹**
26550

- Holds Compressor Clutch in Place When Removing the Holding Bolt
- Adjustable Pins to Fit Various Compressor Clutches
- Compatible with Domestic and Import Vehicles



A/C Clutch Hub Puller and Installer

SKU 1103539 **79⁹⁹**
37150

- Features All the Tools Necessary to Remove and Install Pressed on A/C Clutch Hubs on Many Domestic and Import Vehicles
- Includes: Orifice Tube Extractor Tool Set

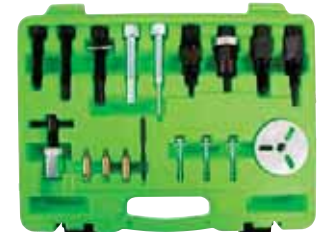

BONUS VALUE: \$19.99

26 Piece Master Orifice Tube Assortment

24564
With Purchase of: 37150

Offer Good While Supplies Last
Through December 31, 2025



A/C Couplers

R134a Manual Coupler Set

SKU 362980 **29⁹⁹**
24396

- All Metal Construction for Extra Durability
- 6-Ball Coupler for Secure Grip
- Includes: Adapter for Use with R12 Hoses



R134a High Side Manual Coupler

SKU 347267 **19⁹⁹**
24395

R134a Low Side Manual Coupler

SKU 347266 **19⁹⁹**
24394

1234yf Manual Coupler Set with 134a Hose Adapters and Acme Adapter

SKU 1544682 **39⁹⁹**
25093

- Couplers Have 12 mm F Threads to Connect to 1234yf Hose Connections
- Two 12 mm M to 14 mm F Brass Adapters Included for Use with 134a Hoses
- Includes: 1/2" M to 1/2" F Left Hand Acme Adapter



R1234yf High-Side Coupler and Adapter Set

SKU 1544684 **24⁹⁹**
25094

R1234yf Low-Side Coupler and Adapter Set

SKU 1544686 **24⁹⁹**
25095

R134a Refrigerant Tank Adapter

SKU 850565 **19⁹⁹**
24554

- Male Low-Side R134a to Female 1/2" ACME
- Attaches to Virgin Tank and Low-Side Service Coupler



R1234yf Low Side Tank Adapter

SKU 1103204 **19⁹⁹**
25086

- Used to Fill Refrigerant from R1234yf Cylinders
- Attaches to Virgin Tank and Low Side Service Coupler
- This Fitting Does Not Have a Valve Core or Valve Core Depressor



R1234yf Hose to Vacuum Pump Adapter Fitting 1/4" x 1/2"

SKU 600806 **14⁹⁹**
24509

- 1/4" SAE x 1/2" ACME Female LH Thread



Valve Core Tools

A/C Valve Core Tool

SKU 466314 **14⁹⁹**
24555

- Double Ended Valve Core Tool to Service Both Standard and Large Bore R134a and R12 Cores



No Gas Loss A/C Valve Core Remover/Installer

SKU 466321 **49⁹⁹**
24529

- Remove and Install Standard R134a Valve Cores without the Loss of Refrigerant
- Built-In Ball Valve Retains Charge and Allows Access to A/C System
- For 13 mm and 16 mm High and Low Service Ports
- Includes Blow Mold Case



Universal Valve Core Remover/Installer for R1234yf

SKU 1043686 **149⁹⁹**
MSC58490-YF

- Attaches to R1234yf Service Ports to Quickly and Easily Remove and Replace Valve Cores without the Loss of Refrigerant
- Ball Valve Design with Stainless Steel Ball Provides Smooth Movement and Durability
- Kit Covers 17 mm and 14 mm High and Low Side Service Ports
- Includes: Valve Assembly, High Side 17 mm Connector, Low Side 14 mm Connector, Standard Valve Core Shaft, GM Large Bore Valve Core Shaft and Eaton R134a/R1234yf High Side Valve Core Shaft



Universal Valve Core Remover/Installer for R134a/R12

SKU 1142576 **244⁹⁹**
MSC58490

- Kit Covers All R12 and R134a System Valve Cores for Standard, JRA, Eaton and GM Large Bore
- Includes: Valve Assembly, R134a High Side 16 mm Connector, R134a Low Side 13 mm Connector, 1/4" FL Swivel Connector, Adapter 1/4"-M x 3/16"-F High Side GM/Ford, Adapter 1/4"-M x 1/8"-F High Side Ford and Blow Mold Case



Prices subject to change without notice. Prices do not include applicable taxes, vehicles, tires, rims, installation or optional equipment as shown. Please do not return purchases to the store. For information regarding warranty, repair, or any questions or concerns, call 901-300-4878.

AZG0425

65

AIR CONDITIONING

SpotGun® Jr.

SpotGun® Jr. Univ. Oil/UV Dye Kit for R134a/R1234yf - 1 Oz.

SKU 1368623 **229⁹⁹**
UVU390100

- Works with Both R134a and R1234Yf Refrigerant Systems
- 4 Universal Oil Cartridges (1 Oz.)
- 2 ExtenDye™ Cartridges (1 Oz.)
- 2 LeakGuard™ OneShot Cartridges (1 Oz.)
- 2 Low-Side Service Adapter Hoses and R134a/R1234yf Couplers



A/C ExtenDye™ Cartridge

- SAE J2297 Certified Super Concentrated
- UV Dye
- Works in R134a, R1234yf Systems and is Hybrid Safe
- Contains Friction Modifier to Increase Lubricity and Decrease Friction
- Contains Antioxidant to Prolong Oil Life
- Anti-Wear Additive for Better Wear Resistance
- Works with SpotGun® Jr. Injection System

A/C ExtenDye™ Cartridge
1 Oz. (4 Pack)

SKU 1362004
UVU399020A

59⁹⁹



A/C ExtenDye™ Cartridge
.25 Oz. (6 Pack)

SKU OSB
UVU399006A

39⁹⁹



Universal PAG 46 Oil for R134a 10z. Cartridge (12 Pack)

SKU 1363781 **99⁹⁹**
UVU399046

- OEM Approved
- Works with SpotGun® Jr. Injection System
- Formulated to Work with R1234yf, R134a and Hybrid Safe
- Sealed Cartridge Assures Clean Oil Delivered to Vehicle A/C System
- Injection System Measures the Correct Dosage

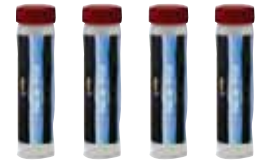

Universal PAG 46 Oil R1234yf - 1 Oz. Cartridge (4 Pack)

SKU 1407808
UVU399046YF

54⁹⁹

SpotGun® Jr. Univ. Oil/UV Dye Kit for R134a/R1234yf - 1 Oz. with UV Lite

SKU 1400039 **299⁹⁹**
UVU390200

- Works with Both R134a and R1234Yf Refrigerant Systems
- Includes UV Phazer (AAA) UV Lite and UV Enhancing Glasses
- 4 Universal A/C Oil (1 Oz.)
- 2 ExtenDye™ Cartridges (1 Oz.)
- 2 LeakGuard™ OneShot Cartridges (1 Oz.)



To Confirm Price, Availability and Ordering Instructions on OSB, Call 901-300-4878

SpotGun®

SpotGun® Univ. Oil/Dye Kit for R134a/R1234yf - 8 Oz. without UV Lite

SKU OSB **199⁹⁹**
UVU490100

- Works with Both R134a and R1234Yf Refrigerant Systems
- 1 Universal Oil Cartridge (8 Oz.)
- 1 ExtenDye™ Cartridge (8 Oz.)
- Service Maintenance Stickers
- 2 Low-Side Service Adapter Hoses and R134a/R1234yf Couplers



SpotGun® Univ. Oil/Dye Kit for R134a/R1234yf - 8 Oz. with UV Lite

SKU OSB **259⁹⁹**
UVU490200

- Works with Both R134a and R1234Yf Refrigerant Systems
- 1 Universal Oil Cartridge (8 Oz.)
- 1 ExtenDye™ Cartridge (8 Oz.)
- UV Phazer™ Black (AAA Batteries Included) UV Enhancing Glasses



A/C ExtenDye™ Cartridge - 8 Oz.

SKU OSB
UVU499108A

79⁹⁹

- Works in R134a, R1234yf Systems and is Hybrid Safe
- Contains Friction Modifier
- Contains Antioxidant to Prolong Oil Life
- Fits Competitive Guns



Mastercool

Professional UV Leak Detection Kit with 12V/50W UV Light

SKU 290041 **99⁹⁹**
MSC53351

- 12 Volt/50 Watt UV Leak Detector
- 1 Oz. Coolant Dye, 1 Oz. Oil/ATF/Fuel Dye, Dye Remover
- Mini Dye Injector (10 Applications of Universal A/C Dye) Compatible with R134a and R12 Adapter
- UV Enhancing Safety Glasses
- 12 Service Labels



Universal Concentrated Dye Cartridge 1 Oz. (5 Pack)

SKU 505040 **99⁹⁹**
MSC53810-5

- 5 Pack of Dye for 53585 Leak Detector Kit
- 10 Applications per Bottle



AIR CONDITIONING

TO ORDER, contact your Commercial Sales Manager or go to AutoZonePro.com

AIR CONDITIONING

UV Leak Detection Lights

13.4" Multi-Use Rechargeable Diagnostic Under-the-Hood Work Light

SKU 591153 **144⁹⁹**
24609

- 5 Hr. Run Time on High



OEM TOOLS

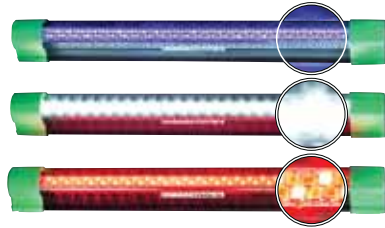

UV Leak Dye Detection Light

400 Lumens Super Bright Work Light

Yellow Smoke Detection Light

Rechargeable UV Flashlight

SKU 1544660
MSC53518UV

109⁹⁹

- High-Intensity LED Ensures Superior Illumination for Accurate Leak Detection
- 2W Lamp Power: Provides Powerful Performance In a Compact Design
- UV Intensity: 154–170 $\mu\text{W}/\text{cm}^2$, Comparable to a 50-Watt UV Flashlight
- UV Wavelength: Operates At 390–400 Nm for Optimal Detection
- Rechargeable Battery: Delivers 3 to 5 Hours of Continuous Use
- Backup Power Option: Includes Holder and 3 AAA Batteries

Mastercool
"World Class Quality"



UV Phazer Professional 395nm Leak Detection Light

- Adjustable Zoom Lens Allows for Focusing Light Intensity in a Smaller/Larger Area for Precision Viewing
- Rechargeable Li-ion Battery

Black

SKU 1405963 **109⁹⁹**
UVUEW40395

- High Output True UV LED Light
- Precise, True UV Wavelength and Bandwidth to Optimize the Fluorescence of UV Dyes
- Max. Run Time: 4 Hrs.



NEO

SKU 1400042 **164⁹⁹**
UVUEW50395

- UV Dye Shines Brighter with the Phazer Neo Than Any Other UV Light
- Water Resistant
- Max. Run Time: 5 Hrs.



UVIEW

UV Leak Detection Light and Glasses

SKU 213144 **24⁹⁹**
24516

- Compact UV Leak Detection Pen Light
- Can Be Used with All Types of UV Leak Detection Dyes
- Yellow Lens Protective Glasses Enhance Visibility of Leaks



OEM TOOLS



2 AA

Magnifying Glass with 5 LED and 1 UV Light

SKU 191688 **14⁹⁹**
25465

- Compact Magnifier with 5 LED Lights and a Super Bright UV Light
- UV Light Detects Dyes



OEM TOOLS

Refillable Injectors

OEM TOOLS

In-Line Dye and Oil Injector

SKU 466322 **39⁹⁹**
24532

- Add Up to 2 Oz. of Oil or Dye to a System Under Vacuum or While Adding Refrigerant
- 1/2" ACME Fittings to Fit Most R134a Systems
- Use with UVU499008A A/C ExtenDye™ Bottle (8 Oz.)



R12 and R134a Hand Turn Dye Injector

SKU 466320 **79⁹⁹**
24528

- Injects Dye or Oil into R12 or R134a Systems
- Refillable, Capacity: 2 Oz.
- Includes: R134a Quick Coupler
- Use with UVU499008A A/C ExtenDye™ Bottle (8 Oz.)



OEM TOOLS

R1234yf Hand Turn Oil and Dye Injector

SKU 213158 **99⁹⁹**
24517

- Easy to Operate Hand Turn Injection
- Durable Aluminum Construction with Laser Etched Filling Guide
- Includes R1234yf System Coupler
- 2 Oz. (60 mL) Capacity
- Use with UVU499008A A/C ExtenDye™ Bottle (8 Oz.)



OEM TOOLS

Refillable Universal Dye Injector for R1234yf

SKU 764999 **164⁹⁹**
MSC53123-YF

- Heavy Duty Aluminum Construction
- Injects Dye or Oil into R1234yf Systems
- Refillable, Any Dye or Oil Can Be Used
- Easy Twist Injection System
- Precise Injection Control



Mastercool
"World Class Quality"

Pourable Dyes

UVIEW

A/C ExtenDye™ Bottle - 8 Oz.

SKU OSB **59⁹⁹**
UVU499008A

- SAE J2297 Certified Super Concentrated UV Dye
- Works in R134a, R1234yf Systems and is Hybrid Safe
- Contains Friction Modifier to Increase Lubricity and Decrease Friction
- Contains Antioxidant to Prolong Oil Life
- Anti-Wear Additive for Better Wear Resistance



For OSB, Call 901-300-4878

Multi-Purpose Dye

SKU 1392316 **49⁹⁹**
UVUB483206

- Pinpoint Leaks in Engine Oil, Transmission, Hydraulic, Power Steering, Gasoline and Diesel Fuel Systems



PAG 100 Oil with A/C ExtenDye™ 8 Oz. Bottle (4 Pack)

SKU OSB **89⁹⁹**
UVU488100PBD4

- PAG 100 Oil
- Contains ExtenDye for Leak Detection
- A/C ExtenDye Includes Additive Package to Reduce Wear
- A/C ExtenDye Will Extend Component Life and Improve A/C Efficiency
- Formulated to Have the Correct Dye/Oil Performance



For OSB, Call 901-300-4878

Prices subject to change without notice. Prices do not include applicable taxes, vehicles, tires, rims, installation or optional equipment as shown. Please do not return purchases to the store. For information regarding warranty, repair, or any questions or concerns, call 901-300-4878.

AZG0425

67

AIR CONDITIONING

Orifice Tube

26 Piece Master Orifice Tube Assortment
SKU 851868 24564 **19⁹⁹** REG. \$29.99



- Covers Most Vehicles That Require Air Conditioning Orifice Tubes
 - Includes: Chrysler (Orange, Purple T-Top), Ford (Black, Blue, Brown, Green, Red), GM (Black T-Top, White, Yellow), Jeep (Green - White) and Volvo (Yellow)
- Offer Good Through December 31, 2025



A/C O-Ring Assortment



270 Piece A/C O-Ring Kit
SKU 271196 68141 **19⁹⁹**

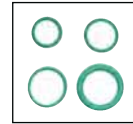

- Great O-Ring Set for Most Automotive and Refrigerant Applications

Kit Contains 270 O-Rings in a Variety of SAE Sizes



Digital Scales

Digital Refrigerant Scale (240 Lb. Capacity)
SKU 752521 24560 **299⁹⁹**



- High-Visibility .75" x 2.5" LCD Backlit Display
- 3 Units of Measure: Kg/Oz./Lb.
- Automatic Shut-Off After 10 Minutes, Backlight Will Shut Off After 3 Minutes
- Fully Enclosed and Removable Metal Scale Platform Enables Use of Product in or Out of the Protective Case



Black Series Electronic Charging Scale with Bluetooth

SKU 290029 MSC98210-BL **299⁹⁹**

- Includes Bluetooth Wireless Technology
- Capacity: 243 Lb.
- Accuracy: $\leq \pm 0.05\%$ of Reading
- Resolution: 0.05 Lb./0.5 Oz./0.01 kg
- Rugged, Non-Slip Platform



A/C Flush

A/C Flush Machine
SKU OSB CPSAFM100

1,799⁹⁹

- Air Operated 8' Hoses to Reach Any System
- Forward or Reverse Flush without Changing Hoses
- 2-1/2 Gallon Capacity Tank for Use on Cars and Buses
- Universal Couplers Allows Connection to Most Types of Connections
- Clear Filter Bowl Allows You to See What is Coming Out of the System with a Cleanable Filter



For OSB, Call 901-300-4878

MASTERCLEANSE A/C Flush Machine

SKU OSB MSC69900 **999⁹⁹**

- Designed to Flush All HVAC/R and Automotive Systems
- Pump Power: 0.4 HP; Flow Rate: 4 Gal/Min.
- Stainless Steel Ball Valve Controls
- 1/4" SAE Connection
- Pump Equipped with Mechanical Seal and PTFE Gasket
- 110 VAC



Adapter Kit

SKU 481575 MSC69925 **149⁹⁹**

- Isolates A/C System Components for Closed Loop Flushing
- Flush Individual Components without Removing Them from the Vehicle
- Install Adapters on A/C Line Ends to Allow Attachment of Flushing Equipment



A/C Flush Kit

SKU 1103579 37377 **69⁹⁹**



- Uses Shop Air to Pressurize the Solvent to Thoroughly Clean the System
- Simple, Effective and Easy to Use
- Attached Nozzle Directs the Solvent without Sprayback
- Includes: Canister, Hose, Blowgun, Rubber Tip and Cylinder Cap
- Solvent Purchased Separately



A/C Flush Solvent

Bottle (32 Oz.)
SKU 695650 MSC91049-32 **24⁹⁹**

1 Gallon
SKU 695653 MSC91049-128 **74⁹⁹**

MSC91049-32



MSC91049-128

AIR CONDITIONING

TO ORDER, contact your Commercial Sales Manager or go to AutoZonePro.com

AIR CONDITIONING

A/C Hose and Line Repair

OEM TOOLS®

Heavy Duty Ratcheting Hose Cutter
SKU **466311** **14⁹⁹**
24522

- Smooth Action and High Quality Blade Provide Quick, Clean and Accurate Cuts
- Ratcheting Action Makes it Faster and Easier to Use than Other Cutters
- Cuts Rubber Hose and PVC Up to 1-1/2" OD
- Wide Hooked Jaws Hold Tubing Securely



Ratcheting Tubing Cutter
SKU **466309** **29⁹⁹**
24520

OEM TOOLS®

- Ratcheting Action is Ideal Where Space is Limited
- Cuts 1/4" to 7/8" Tubing
- Spare Cutting Wheel Included



Thermometers

OEM TOOLS®

Thermal Imaging Camera
SKU **213193** **199⁹⁹**
24552 REG. \$299.99

SAVE \$100

- Temperature Range: -4°F to 1,202°F (-20°C to 650°C), Selectable Temperature (C or F)
- Captures Thermal Images and Saves to MicroSD Card (Not Included)
- 3 Selectable Color Palettes
- 1.8" LCD Color Display
- Includes Storage Pouch and Mini USB Cable



Offer Good While Supplies Last Through December 31, 2025

Manual Style A/C Hose Crimper, Bench or Vise Mounted

SKU **290028** **369⁹⁹**
MSC71550

Mastercool®
"World Class Quality"

- Manual Style A/C Hose Crimper
- Mount to Bench Using Holding Fixture or Place in Vise
- Includes: 71500 - 001 Yoke Assembly, 71550 - 002 Arbor Assembly, 71550 - 003 Holding Fixture Assembly, 71500 - 6 Die Set - #6 (5/16"), 71500 - 8 Die Set - #8 (13/32"), 71500 - 10 Die Set - #10 (1/2"), 71500 - 12 Die Set - #12 (5/8") and 71500-PB Custom Mold Box Carrying Case



Non-Contact Infrared Thermometer

SKU **951642** **39⁹⁹**
25245

- Point-and-Click Non-Contact Thermometer Uses a Laser Pointer to Give Precise Temperature Readings Ranging from -58°F to 716°F (-50°C to 380°C)
- Laser Pointer Identifies the Spot to Be Measured and Provides Accurate Temperature Measurements from a 12:1 Distance-to-Spot Ratio (Emissivity 0.95 Preset)
- Lightweight and Easy to Operate with an LCD Backlit Display That Makes it Effective Even in Low Light Situations
- Auto Power-Off Feature Conserves Battery Power by Shutting Thermometer Off After 7 Seconds of Non-Use
- 9V Battery Included (Typical Battery Life: 22 Hours in Non-Laser Mode, 12 Hours in Laser Mode)



AirSept® Line Repair

SAVE TIME & MONEY!

CERTIFIED LEAK-FREE

UP TO 2,600 psi

OE-APPROVED REPAIR SOLUTION INSTALLS IN MINUTES, NO SPECIAL TOOLS, NO GLUE

FIX or TERMINATE a Line in 5 MINUTES!

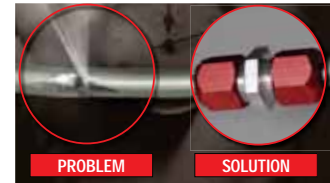

Line Terminator SAE (5 Pack)

SKU **504122** **109⁹⁹**
AIR76526

- Quickly and Effectively Blocks A/C Lines at the Damage Point or at the Front System "Y"
- Block Off Leaking Rear Evaporators and Failed System Components
- Include One Each: 5/16", 3/8", 1/2", 5/8" and 3/4" SAE Kits



Line Terminator SAE/Metric (10 Pack)

SKU **504124** **199⁹⁹**
AIR76530

- Quickly and Effectively Blocks A/C Lines at the Damage Point or at the Front System "Y"
- Block Off Leaking Rear Evaporators and Failed System Components
- Includes One Each: 5/16", 3/8", 1/2", 5/8", 3/4", 8 mm, 10 mm, 12 mm, 15 mm and 16 mm



Line Splice Straight SAE/Metric (10 Pack)

SKU **504103** **284⁹⁹**
AIR76051

- Includes One Each: 5/16", 3/8", 1/2", 5/8", 3/4", 8 mm, 10 mm, 12 mm, 15 mm and 16 mm



Line Terminator Rear A/C Blockoff Kits

- Quickly and Effectively Blocks A/C Lines at the Damage Point or at the Front System "Y"
- Block-Off Leaking Rear Evaporators and Failed System Components
- Help Maximize Front A/C Performance
- Eliminate Refrigerant and Oil Pooling in Rear A/C Lines



SKU	Part #	Size	Price
504149	AIR76502	3/8" Line	26.99
504146	AIR76501	1/2" Line	26.99
504150	AIR76503	5/16" Line	26.99
504152	AIR76504	5/8" Line	30.99
504154	AIR76505	3/4" Line	35.99
329221	AIR77508	8 mm OD Line	26.99
329219	AIR77510	10 mm OD Line	26.99
329231	AIR77515	15 mm OD Line	30.99
329230	AIR77516	16 mm OD Line	30.99

Line Splice Straight Repair Kit

- High-Tech Anti-Vibration Tension Ring Ensures Durability in Tough Automotive Applications
- HNBR Seal Sleeve Dramatically Expands the Sealing Surface Area
- Burst Tested to 2,600 psi



SKU	Part #	Size	Price
504140	AIR76003	5/16" Line	35.99
504138	AIR76002	3/8" Line	35.99
504136	AIR76001	1/2" Line	35.99
504143	AIR76011	5/8" Line	44.99
504132	AIR77008	8 mm Line	35.99
504155	AIR77010	10 mm Line	35.99

Smart Splice™ Line to Hose

- Leak-Proof Line Splice™ Technology on the Metal Side of the Connection
- Superior Hose Crimp Technology on the Rubber Side
- Also Works for Heater and Coolant Lines
- Install in 5 Minutes



SKU	Part #	Size	Price
504125	AIR76701	1/2" Line to #8 Hose	35.99
504128	AIR76702	3/8" Line to #6 Hose	35.99

Prices subject to change without notice. Prices do not include applicable taxes, vehicles, tires, rims, installation or optional equipment as shown. Please do not return purchases to the store. For information regarding warranty, repair, or any questions or concerns, call 901-300-4878.

AZG0425

AIR COMPRESSORS



Description and Part Number	3.5 HP 60 Gallon 230V Air Compressor, Single Phase SKU OSB ABA3-2160V1	5 HP 60 Gallon 230V Air Compressor, Single Phase SKU OSB ABA5-2160V4	5 HP 80 Gallon 230V Air Compressor, Single Phase SKU OSB ABA5-2180V4NS	5 HP 80 Gallon 230V Air Compressor SKU OSB ABAC5-2180V - Single Phase ABAC5-2380V - 3 Phase	7.5 HP 80 Gallon 230V Air Compressor SKU OSB ABAC7-2180V2 - Single Phase ABAC7-2380V2 - 3 Phase	13 HP 30 Gallon Honda Powered Air Compressor SKU OSB ABA13-30GH	10 HP 120 Gallon 230V Air Compressor, 3 Phase SKU OSB ABAC10-23120V
CARB Compliant	N/A	N/A	N/A	N/A	N/A	Yes	N/A
CFM at 100 psi	12.3 CFM (1 Technician)	15.4 CFM (1-2 Technicians)	15.4 CFM (1-3 Technicians)	18 CFM (2-3 Technicians)	27 CFM (2-4 Technicians)	23 CFM (1-3 Technicians)	35 CFM (3-6 Technicians)
Max. Pressure	135 psi	175 psi	175 psi	175 psi	175 psi	175 psi	175 psi
Heavy Duty, Low-RPM Cast Iron Pump	Cast Iron Cylinders	Cast Iron Cylinders	Cast Iron Cylinders	Yes	Yes	Cast Iron Cylinders	Yes
Magnetic Starter Mounted and Wired	Not Required	Not Required	Not Required	Yes	Yes	Recoil and Electric Start	Yes
High Flow Belt Guard	Yes	Yes	Yes	Yes	Yes	Yes	Yes
<i>Price</i>	<i>1,269⁹⁹</i>	<i>1,699⁹⁹</i>	<i>2,099⁹⁹</i>	<i>2,999⁹⁹</i>	<i>3,799⁹⁹</i>	<i>3,499⁹⁹</i>	<i>4,999⁹⁹</i>

Premium Models

7.5 HP 80 Gallon 230V
SKU OSB
ABAC7-2180V2FF

4,549⁹⁹

- Vertical 80 Gallon Tank
- Horsepower: 7.5 HP
- Power Supply (V/Ph): 230V/1
- CFM @ Max. psi: 24
- Max. psi: 176



10 HP 120 Gallon 230V
SKU OSB
ABAC10-23120VFF

5,599⁹⁹

- Vertical 120 Gallon Tank
- Horsepower: 10 HP
- Power Supply (V/Ph): 230V/3
- CFM @ Max. psi: 32
- Max. psi: 176



Premium Models Include: Low Oil Level Shut Off, Auto Tank Drain and Belt Guard Aftercooler



BEFORE PLACING YOUR AIR COMPRESSOR ORDER:

Ensure you select the right size for your needs. We can help you with size selection. Please remember to verify the voltage and phase before purchasing. Upgrading your air compressor may require upgrading your wiring.

See page 2 for delivery information. Questions? **Call 901-300-4878.**



Customer Responsible For Offloading, Liftgate Service Available.

For OSB, Call 901-300-4878

- Free Delivery in 48 Continental United States
- Specifications Subject to Change without Notice or Liability
- Equipment Lead Times and Shipping May Vary
- Customers Responsible for Offloading Equipment Upon Arrival
- Leasing Terms Available, Ask Your AutoZone® Commercial Sales Manager.

AIR COMPRESSORS

FOR HELP with Selection, Confirm Availability and Ordering Instructions, Call 901-300-4878

AIR COMPRESSORS

Rotary Screw Compressors

- High Performance with Low Energy Consumption
- Low Noise and Vibration Levels
- Fully Integrated Aluminum Block

Rotary Screw Compressors are an Ideal Solution for Applications Where There is Continuous Demand for Dependable Compressed Air



10 HP 131 Gallon 150 psi Screw Compressor with Dryer

SKU **OSB**
ABAAS-10503TMD **8,949⁹⁹**

- 208V-230V-460V/3PH
- 34.1 CFM



ABAAS-10503TMD

15 HP 131 Gallon 150 psi Screw Compressor with Dryer

SKU **OSB**
ABAAS-15503TMD **12,149⁹⁹**

- 208V-230V-460V/3PH
- 46.4 CFM

7.5 HP 131 Gallon 150 psi Screw Compressor

SKU **OSB**
ABAAS-75501TM

- 7,199⁹⁹**
- 230V/1PH
 - 27.1 CFM



ABAAS-75501TM

BelAire

5 HP 60 Gallon 230V Air Compressor, Single Phase

SKU **OSB**
IMC4916V

1,679⁹⁹

- 15.4 CFM @ 100 psi
- 165 psi Max. Pressure
- Cast Iron Cylinders
- 2 Stage Pump
- No Start-Up Kit Required
- High Flow Belt Guard
- Warranty: 2 Year Factory



5 HP 80 Gallon 230V Air Compressor, Single Phase

SKU **OSB**
IMC418V

2,999⁹⁹

- 18 CFM @ 100 psi
- 175 psi Max. Pressure
- Solid Cast Iron 2 Stage Pump
- Magnetic Starter Included
- Fully Enclosed Belt Guard
- Warranty: 2 Year Factory



Champion®

- 100% Cast Iron Pump with Alloy Steel Reed Valves
- Warranty: 1 Year Unit Parts and Labor, 2 Years Pump Parts and Labor

5 HP 80 Gallon RV Series VRV5-8

SKU **OSB**
CHCRV215AS01

Call for Price

- 230V/1ph
- 17.0 CFM @ 175 psi
- 3600 RPM Motor, No Starter Needed

5 HP 80 Gallon RV Series VRV5-8 with Starter

SKU **OSB**
CHCRV215AS07

Call for Price

- 230V/1ph
- 16.5CFM @ 175 psi
- 1800 RPM Motor with Magnetic Starter



CHCRV215AS07

Contact Your TSM for BEST PRICING

Refrigerated Dryers

- Removes Condensate and Vapor So Dry Compressed Air is Produced in a Continuous, Cost-Efficient Way
- 115 VAC

Cool 15 CFM

SKU **OSB**
ABACOOOL15

869⁹⁹

Cool 25 CFM

SKU **OSB**
ABACOOOL25

1,079⁹⁹

Cool 35 CFM

SKU **OSB**
ABACOOOL35 **1,299⁹⁹**

ABACOOOL15



Mi-T-M

30 Gallon Air Compressor/Generator

SKU **OSB**
MTMAG2SM1430ME

3,599⁹⁹

- CFM @ 175 psi 15.7
- Max. AC Output: 4000 Watts
- Continuous with Compressor On Load 2300 Watts
- Continuous with Compressor Off Load 3500 Watts
- Receptacles 2 NEMA 5-20R, 1 NEMA L6-20R
- Displacement/Engine 420cc Mi-T-M OHV
- Compressor Two Stage, Cast Iron Pump



Customer Responsible For Offloading, Liftgate Service Available.

For OSB, Call 901-300-4878

- Free Delivery in 48 Continental United States
- Specifications Subject to Change without Notice or Liability
- Equipment Lead Times and Shipping May Vary
- Customers Responsible for Offloading Equipment Upon Arrival
- Leasing Terms Available, Ask Your AutoZone® Commercial Sales Manager.

Prices subject to change without notice. Prices do not include applicable taxes, vehicles, tires, rims, installation or optional equipment as shown. Please do not return purchases to the store. For information regarding warranty, repair, or any questions or concerns, call 901-300-4878.

AIR TOOLS

1/2" Impact Wrenches

Heavy Duty 1/2" Composite Stubby Impact Wrench

SKU **087596** **179⁹⁹**
24418

- Torque: 900 Ft/Lb.
- Includes (7) 1/2" Short Impact Sockets Sizes: 13 mm to 19 mm
- Custom Cut EVA Foam Storage Tray
- CFM: 4.0



WARRANTY: 1 Year

1/2" Impact Wrench

SKU **970487** **234⁹⁹**
IRT231HA

- Torque: 590 Ft/Lb.
- Pressure-Fed Lubrication System
- In-Handle Exhaust Directs Air Away from User
- Industry Standard for 3 Decades
- Sound Pressure: 94 to 105 dBA



WARRANTY: 1 Year

1/2" Super Duty Air Impact Wrench with Extended Anvil

SKU **604744** **264⁹⁹**
IRT231HA2

- Max. Torque: 590 Ft/Lb.
- In-Handle Exhaust Directs Air Away from User
- Pressure-Fed Lubrication System



WARRANTY: 1 Year

1/2" Air Impact Wrench Classic

SKU **495316** **199⁹⁹**
IRT231C

- Original Twin Hammer Impact
- Torque: 600 Ft/Lb.
- Pressure-Fed Lubrication
- Adjustable Power Regulator
- 1/2" Square Drive



WARRANTY: 1 Year

1/2" Quiet Impact Wrench

SKU **738489** **369⁹⁹**
IRT2135QXPA

- Torque: 780 Ft/Lb.
- Light, Quiet and Powerful Impact
- Twin Hammer Mechanism
- Weighs Only 4 Lb.



WARRANTY: 1 Year

1/2" Titanium Air Impact Wrench

SKU **695134** **519⁹⁹**
IRT2235TIMAX

- Torque: 1,350 Ft/Lb.
- Reverse Torque: 930 Ft/Lb.
- Twin Hammer Impact Mechanism
- Lightweight



WARRANTY: 2 Years

1/2" Titanium Air Impact Wrench with Extended Anvil

SKU **738490** **549⁹⁹**
IRT2235TIMAX2

- Torque: 1,350 Ft/Lb.
- Max. Reverse Torque: 930 Lb.
- 8,500 Free Speed RPM
- Titanium Hammercase



WARRANTY: 2 Years

1/2" Nitrocat Composite Twin Clutch Impact Wrench

SKU **1580951** **384⁹⁹**
ACA1250K

- Provides 950 Ft/Lb. Max. Torque and 1,300 Ft/Lb. of Loosening Torque
- Hard Hitting Smooth Twin Clutch Mechanism
- The Twin Clutch is Better Suited for Heavy Duty
- Weight: 4.5 Lb.



WARRANTY: 2 Years

1/2" Compact Impact Wrench

SKU **1580967** **199⁹⁹**
ACA1057-TH

- Provides 500 Ft/Lb. Max. Torque and 700 Ft/Lb. of Loosening Torque
- Low Weight Aluminum Alloy Housing
- Weight: 2.80 Lb.
- Length: 3.85"
- Air Inlet: NPT 1/4"



WARRANTY: 2 Years

1/2" Composite Impact Wrench

SKU **OSB** **229⁹⁹**
ACA1150

- Provides 900 Ft/Lb. Max. Torque and 1,295 Ft/Lb. of Loosening Torque
- Durable Composite Housing
- Weight: 4.5 Lb.
- Length: 7.5"
- Free Speed: 9,000 RPM



WARRANTY: 2 Years

For OSB, Call 901-300-4878

1/2" Impact Wrench

SKU **1580946** **119⁹⁹**
ACA1431

- Provides 800 Ft/Lb. Max. Torque and 1,000 Ft/Lb. of Loosening Torque
- Cross Bolt Forward/Reverse and Power Management Control
- Weight: 5.7 Lb.
- Length: 7.2"
- Free Speed: 9,000 RPM



WARRANTY: 2 Years

1/2" Composite Impact Wrench

SKU **1580952** **279⁹⁹**
ACA1000TH

- Provides 800 Ft/Lb. Max. Torque and 1,000 Ft/Lb. of Loosening Torque
- Patented Quiet Tuned Exhaust (86 dBA)
- Air Cons.: (CFM) 8
- Weight: 4.5 Lb.
- Length: 7.5"



WARRANTY: 2 Years

1/2" Vibrotherm Drive Composite Impact Wrench

SKU **1580965** **354⁹⁹**
ACA1178-VXL

- Provides 950 Ft/Lb. Max. Torque and 1,300 Ft/Lb. of Loosening Torque
- Weight: 4.5 Lb.
- Free Speed: 7,500 RPM
- Air Inlet: NPT 1/4"



WARRANTY: 3 Years

Prices subject to change without notice. Prices do not include applicable taxes, vehicles, tires, rims, installation or optional equipment as shown. Please do not return purchases to the store. For information regarding warranty, repair, or any questions or concerns, call 901-300-4878.

AIR TOOLS

TO ORDER, contact your Commercial Sales Manager or go to AutoZonePro.com

AIR TOOLS

3/8" Impact Wrench



3/8" Titanium Impact Wrench
SKU 198065
IRT2115TIMAX

329⁹⁹

- Torque: 300 Ft/Lb.
- Feather Touch Trigger and Patented Push Button Forward/Reverse



WARRANTY: 2 Years

3/4" Impact Wrench



3/4" Composite Impact Wrench
SKU 1580960
ACA1778-VXL

659⁹⁹

- Provides 1,450 Ft/Lb. Max. Torque and 1,700 Ft/Lb. of Loosening Torque
- The Latest Patented Aircat Muffler System Provides the Aircat's Unmatched Low Noise Levels
- Weight: 7.7 Lb.
- Length: 7.7"
- Free Speed: 5,400 RPM



WARRANTY: 3 Years

Don't Forget Your Air Hose Couplers

70% MORE FLOW



See Page 75

Air Ratchets



3/8" Air Ratchet
SKU 970485
IRTIR107XPA

154⁹⁹

- Max. Torque: 54 Ft/Lb.
- Advanced Head Design
- 360° Adjustable Exhaust



WARRANTY: 1 Year

1/4" Super Duty Air Impact Ratchet

SKU 850508
24415

49⁹⁹

Impact Mechanism Adds Power and Prevents Kickback

- Max. Torque: 50 Ft/Lb.
- Free Speed: 700 RPM
- CFM: 3.1 @ 90 psi
- Length: 6.5"
- Sealed Head Ratchet Housing Prolongs Tool Life
- Compact and Lightweight
- Most Power-to-Weight Ratio
- Rear Air Exhaust: 360° Adjustable

WARRANTY: 1 Year



Composite Body

3/8" Super Duty Air Impact Ratchet

SKU 850055
24416

209⁹⁹

- Max. Torque: 50 Ft/Lb.
- Free Speed: 700 RPM
- CFM: 3.1 @ 90 psi
- Length: 6.5"
- Sealed Head Ratchet Housing Prolongs Tool Life
- Compact and Lightweight
- Most Power-to-Weight Ratio
- Rear Air Exhaust



WARRANTY: 1 Year

Air Hammers

Standard Duty Air Hammer
SKU 1392327
IRT117

109⁹⁹

- 2,000 Blows per Minute
- Heat-Treated Piston and an Alloyed Steel Barrel



WARRANTY: 1 Year

121Q Super Duty Air Hammer

SKU 478945
IRT121Q

164⁹⁹

- Ideal for Body Panel Crimping and Cutting, Bushing Driving, Shearing and General Front End Work
- Built-In Power Regulator and Trigger Control
- Easy to Control with an "Easy Out" Throttle



WARRANTY: 1 Year

Cut-Off Tools



3" Air Cut-Off Tool

SKU 466590
25760

39⁹⁹

- Air Inlet Thread Size: 1/4" NPT
- Free Speed: 22,000 RPM
- Recommended Air Pressure: 90 psi

SAVE \$25



WARRANTY: 1 Year

Offer Good Through December 31, 2025

Air Drill



3/8" Capacity Keyless Composite Pistol Grip Drill
SKU 1580948
ACA4338

144⁹⁹

- Air Consumption: (CFM) 6
- 1,800 RPM
- Reversible and Variable Speed
- Length: 7"



WARRANTY: 2 Years

Inflators



Digital Tire Inflator
SKU 802198
24412

99⁹⁹

- Easy-to-Read Backlit LCD Display
- 4 Units of Measure (psi, Bar, KPa, kgf)
- Measuring Range: 0 to 175 psi (0 - 12 Bar)
- Accuracy: +/-1.2 psi Up to 58 psi, +/-2.3 Between 58 psi and 145 psi Inclusive, +/-3.6 psi Greater Than 145 psi
- High Air Flow Saves the Technician Time



2 AAA



Dial Tire Inflator

SKU 301772
24380

89⁹⁹

- Clear and Easy-to-Read 80 mm 180 psi Gauge
- 3-In-1 Function: Inflate, Deflate and Measure Tire Pressure
- Increased Accuracy to Improve Tire Performance and Prevent TPMS Comebacks



3.5" Digital Tire Inflator with Hose

SKU 1268419
AST3018

114⁹⁹

- 21" Stainless Braided Hose
- Dual AAA Battery Powered Design
- Backlit LCD Digital Read-Out
- Includes Batteries



Dual Head Chuck Tire Inflator Gauge

SKU 094652
25864

34⁹⁹

- 6" Chrome Plated Dual-Head Chuck with Full 360° Swivel Action
- 15" Air Hose with 1/4" Female NPT and 3/8" 24 Thread Air Intake
- Inflates within 10 to 120 Lb. Pressure Range
- Magnifying Bubble Lens, Allows Full View of the Pressure Scale
- Gauge in 2 Lb. Increments



Prices subject to change without notice. Prices do not include applicable taxes, vehicles, tires, rims, installation or optional equipment as shown. Please do not return purchases to the store. For information regarding warranty, repair, or any questions or concerns, call 901-300-4878.

AIR TOOLS

Surface Prep

Heavy Duty Mini Surface Prep Kit

SKU **087620** **79⁹⁹**
24417 REG. \$174.99

- 2" and 3" Heavy Duty Mini Air Surface Prep Sander
- (1) 2" Backer Pad
- (1) 3" Backer Pad
- (2) 2" and (2) 3" Medium Grit Surface Prep Discs
- (2) 2" and (2) 3" Coarse Surface Prep Discs
- (2) 2" and (2) 3" Sander Discs
- Blow Mold Case

SAVE \$95



WARRANTY: 1 Year

Offer Good Through December 31, 2025

1/4" Mini Angle Die Grinder and Surface Prep Kit

SKU **94648** **124⁹⁹**
25777

- Air Consumption: 4 CFM
- Free Speed: 20,000 RPM
- Grinding and Cleaning All-in-One Kit
- Comes in a Heavy Duty Plastic Tray



WARRANTY: 1 Year

Air Sanders

2" Surface Prep Air Sander

SKU **094650** **89⁹⁹**
25778

- Includes Quick Change "Twist Lock" Mandrel
- Free Speed: 20,000 RPM
- Average Air Consumption: 3.2 CFM
- Air Inlet Thread Size: 1/4" NPT



WARRANTY: 1 Year

Heavy Duty Reciprocating Air Saw

SKU **802225** **79⁹⁹**
24409 REG. \$169.99

- Recommended Air Pressure: 90 psi
- Air Consumption: 1.7 CFM
- Strokes per Minute: 9,000 SPM
- Air Inlet Thread Size: 1/4" NPT
- Lightweight: 1.50 Lb. (0.70 kg)
- Length: 10.6" (270 mm)
- Exhaust: Front
- Enhanced Blade Guard Design and Trigger Safety Lock
- Includes: Reciprocating Air Saw, 2 Hex Key Wrenches, 2 Saw Blades and 2 Blade Guards

SAVE \$90



WARRANTY: 1 Year

Offer Good Through December 31, 2025

6" Dual Action Sander

SKU **970475** **109⁹⁹**
IRTIR311A

- Dual Action Pad Motion Reduces Swirl
- Built-In Silencer for Quiet Operation



WARRANTY: 1 Year

IR Ingersoll Rand

Straight Line Sander

SKU **970479** **189⁹⁹**
IRTIR315

- Twin Piston Design for Smooth Operation
- 3,000 Strokes per Minute
- Quick-Action Paper Clamps



WARRANTY: 1 Year

IR Ingersoll Rand

1/4" Die Grinders

Composite Body with Built-In Silencing to Reduce Noise Level

Mini Air Die Grinder

SKU **751631** **29⁹⁹**
24404 REG. \$54.99

- Air Consumption: 2.4 CFM
- Free Speed: 25,000 RPM
- Recommended Air Pressure: 90 psi

SAVE \$25



WARRANTY: 1 Year

Offer Good Through December 31, 2025

1/4" Air Die Grinder

SKU **802212** **49⁹⁹**
24406 REG. \$64.99

- Air Consumption: 3.4 CFM
- Free Speed: 22,000 RPM
- Recommended Air Pressure: 90 psi
- Exhaust: Rear 360°

SAVE \$15



WARRANTY: 1 Year

Offer Good Through December 31, 2025

Mini Angle Air Die Grinder

SKU **802214** **124⁹⁹**
24407

- Air Consumption: 2.8 CFM
- Free Speed: 18,000 RPM
- Recommended Air Pressure: 90 psi
- Built-in Silencing to Reduce Noise Level

OEM TOOLS

Extended Air Die Grinder

SKU **802216** **39⁹⁹**
24408 REG. \$89.99

- Air Consumption: 2.5 CFM
- Free Speed: 23,000 RPM
- Recommended Air Pressure: 90 psi

SAVE \$50



(Color May Vary)

WARRANTY: 1 Year

Offer Good Through December 31, 2025

Mini Air Die Grinder

SKU **802211** **29⁹⁹**
24405 REG. \$64.99

- Air Consumption: 3.4 CFM
- Free Speed: 25,000 RPM
- Recommended Air Pressure: 90 psi

SAVE \$35



WARRANTY: 1 Year

Offer Good Through December 31, 2025



WARRANTY: 1 Year

AIR TOOL ACCESSORIES

TO ORDER, contact your Commercial Sales Manager or go to AutoZonePro.com

AIR TOOL ACCESSORIES

Impact Sockets and Extensions

1/2" Drive Impact Extension Set
SKU 1340235 **114⁹⁹**
SUN2500



- Set Includes: 1/2" Dr. 3", 5", 10" and 15" Impact Extensions
- Comes in a Blow Mold Case



3/8" Impact Sockets

- 6 Pt. High Quality Impact Sockets
- SAE: 5/16", 3/8", 7/16", 1/2", 9/16", 5/8", 11/16", 3/4", 13/16", 7/8", 15/16" and 1"
- Metric: 8, 9, 10, 11, 12, 13, 14, 15, 16, 17, 18 and 19 mm



Posi-Grip No Slip™ Design Provides Superior Gripping Power for Maximum Torque
Chrome Moly Steel Construction for Strength and Durability

12 Piece Shallow (SAE)
SKU 391191
25589
34⁹⁹

12 Piece Shallow (Metric)
SKU 391190
25587
34⁹⁹



12 Piece Deep (SAE)
SKU 442193
25590
39⁹⁹ **SAVE \$25**
REG. \$64.99

12 Piece Deep (Metric)
SKU 464314
25588
39⁹⁹ **SAVE \$25**
REG. \$64.99



Offers Good Through December 31, 2025

33 mm 1" Drive Budd Style Wheel Socket
SKU 466569 **34⁹⁹**
25528



- 1" Drive 33 mm Budd Wheel Socket for Mack, Midliner, Volvo, White and Other Import Trucks with Dual Rear Wheels



1/2" Impact Sockets

- 6 Pt. High Quality Impact Sockets
- SAE: 3/8", 7/16", 1/2", 9/16", 5/8", 11/16", 3/4", 13/16", 7/8", 15/16" and 1"
- Metric: 10, 11, 12, 13, 14, 15, 16, 17, 18 and 19 mm



11 Piece Shallow (SAE)
SKU 391195
25593
39⁹⁹

10 Piece Shallow (Metric)
SKU 391192
25591
34⁹⁹



11 Piece Deep (SAE)
SKU 391196
25594
44⁹⁹ **SAVE \$20**
REG. \$64.99

10 Piece Deep (Metric)
SKU 391194
25592
39⁹⁹ **SAVE \$15**
REG. \$54.99



Offers Good Through December 31, 2025

1-1/2" Hex x 13/16" Square Deep 1" Drive Budd Style Wheel Socket
SKU 466570 **29⁹⁹**
25529



- For Budd Wheel 1-1/2" Hex with 13/16" Inside Square



Impact Adapters



5 Piece Adapter and Universal Joint Set (3/8" and 1/2")
SKU 965864 **34⁹⁹** **SAVE \$15**
24226 REG. \$49.99

- Chrome Moly Steel Construction
- Includes: 3/8" Drive Universal Joint, 3/8" Drive (F) x 1/2" (M) Adapter, 1/2" Drive Universal Joint, 1/2" Drive (F) x 3/8" (M) Adapter and 1/2" Drive (F) x 3/4" (M) Adapter



Offer Good Through December 31, 2025

Air Blow Gun



5 Piece Interchangeable Tip Air Blow Gun
SKU 338823 **24⁹⁹**
24439

- Includes 4 Interchangeable Tips: 100 mm (4"), 140 mm (5.5"), 320 mm (12.5") and a Turbo Wide Angle Nozzle
- Quick Change Coupling Makes it Easy to Change Tips
- Wide Angle Nozzle for High Volume
- Variable Trigger to Control Volume and Tip Pressure
- 1/4" NPT Air Inlet



High Flow Couplers

High Flow Coupler and Plug Kits

70% MORE FLOW*

- Ideal for HVLP Spray Guns and High Torque Impact Wrenches
- Delivers the Highest Air Volume with the Lowest Pressure Drop

14 Piece 1/4" Body, 1/4" NPT
SKU 757091 **24⁹⁹**
26134



7 Piece 1/4" Body, 1/4" NPT
SKU 757040 **14⁹⁹**
26132



7 Piece 1/4" Body, 3/8" NPT
SKU 757046 **19⁹⁹**
26133



*When Paired Together, OEMTOOLS High Flow Couplers and Plugs Deliver Up to 70% More Flow than Conventional Couplers

Prices subject to change without notice. Prices do not include applicable taxes, vehicles, tires, rims, installation or optional equipment as shown. Please do not return purchases to the store. For information regarding warranty, repair, or any questions or concerns, call 901-300-4878.

AIR TOOL ACCESSORIES

Surface Prep

Superior Quality Surface Prep Tools



Try our longer lasting surface prep disks that save you time and money.

Surface Prep Discs (25 Pack)

- Twist-Lock Style

2" Coarse

SKU 1330684
22517

19⁹⁹
(0.79 each)



2" Medium

SKU 1335806
22516

19⁹⁹
(0.79 each)

3" Coarse

SKU 1335795
22518

34⁹⁹
(0.99 each)



3" Medium

SKU 1335787
22519

34⁹⁹
(0.99 each)



Tool Not Included

2" Twist-to-Lock Surface Prep Discs (50 Pack) with Cookie Jar



Coarse
SKU 1146029
SHA13088

84⁹⁹

Medium
SKU 1146030
SHA13089

84⁹⁹

Assorted
SKU 1168677
SHA13087

49⁹⁹

REG. 84.99

- Includes: Coarse, Medium and Fine

Offer Good Through
December 31, 2025

**SAVE
\$35**



2" Purple Strip Disc with Twist-Lock (5 Pack)



SKU 298097
SHA16206

24⁹⁹

- Long-Life Silicon Carbide for Paint and Coating Removal

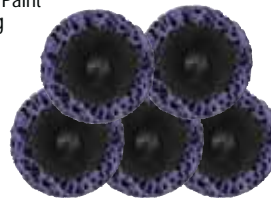

2" Twist-Lock Mini Flap Discs Assorted Grits (6 Pack)



SKU 306275
SHA13056

39⁹⁹

- Outlasts Mini Grinding Discs by 3 Times
- Includes: 2 Each of 40, 60 and 80 Grit

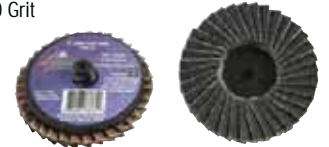

Twist-Lock Disc Holders

SKU 1368617
SHA13012

17⁹⁹

- 2" Holder (Single)



SKU 094911
SHA323T2

29⁹⁹

- 2" Holder (2 Pack)



Twist-to-Lock Green Zirconia Mini Grinding Discs



Green Zirconia



SKU	Part #	Size	Grit	Qty	Price
306282	SHA12613	2"	36	25	44.99
305896	SHA12614	2"	50	25	44.99
204022	SHA12615	2"	80	25	44.99
305827	SHA12618	3"	50	25	54.99
204009	SHA12619	3"	80	25	54.99

Cut-Off Accessories



Mandrel Set for Cut-Off Tools (2 Pack)

SKU 094907
SHA32

29⁹⁹



10 Piece Cut-Off Wheel Set with Mandrel

SKU 1400046
26528

14⁹⁹

- Capable of Cutting Fiberglass, Plastic, Iron, Steel and Other Ferrous Metals
- Quantity: (10) 3" x 1/16" Cut-Off Wheels with 3/8" Arbor, 46 Grit
- Max. RPM: 20,400



3" Aluminum Cutting Wheels (10 Pack)

SKU 306331
SHA13178PK2

59⁹⁹

- Silicon Carbide Grain
- Includes: (10) 3" x 1/16" x 3/8" Cut-Off Wheels
- Works on 3" Die Grinders



3" x 1/16" x 3/8" Reinforced Cut-Off Wheels (25 Pack)

SKU 306273
SHA25E5PK5

44⁹⁹

- For Use with Pneumatic Cut-Off Tools
- Max. RPM: 25,000
- Includes: 25 Discs



Air Piping



MaxLine Compressed Air Piping System 3/4" Master Kit

SKU 360593
RAPM7500

269⁹⁹

Aluminum Core: Holds Any Bent Shape!

- Heavier Duty Components for Longer Air Runs in Larger Buildings
- 3 Air Outlets, (1) 3/4" NPT Straight Fitting, 2 Tees, 20 Clips and 100' of 3/4" HDPE Tubing



RAPM7500

1/2" Tubing Master Kit

SKU 360485
RAP90500

169⁹⁹

See More RapidAir® Products on AutoZonePro.com

AIR TOOL ACCESSORIES

TO ORDER, contact your Commercial Sales Manager or go to AutoZonePro.com

AIR TOOL ACCESSORIES

Regulators/Filters/Drains

5 Stage Desiccant Filter/Dryer
SKU **543076** **499⁹⁹**
ARRC7612XL

- Includes: Gauge, Shut-Off Valve and (1) 1/2 Gallon of Desiccant
- Lowers the Dew Point to -30°F



For OSB, Call 901-300-4878

NAME	SKU	PART #	PRICE
Replacement Desiccant Silica Gel, 1 Quart	OSB	ARR34189	24.99

Regulator with Gauge (1/4")
SKU **543086** **49⁹⁹**
ARRR262G

- Adjustment Range is 5 to 125 psig
- Rated for 25 SCFM



Filter Regulator Lubricator (1/2")
SKU **543075** **259⁹⁹**
ARRC33354

- Cleans, Dries and Lubricates Air Supply
- Operating Pressure Range: 5 to 125 psi
- 40 Micron Element
- 142 CFM



Extend the Life of Your Air Tools!

1/2" Electronic Drain
SKU **543065** **89⁹⁹**
ARR5804

- Automatically Drains Compressor Tanks, Receiver Tanks or Filters
- 110 Volt
- 6' Power Cord



Filter/Regulator (1/2")
SKU **543071** **99⁹⁹**
ARRB754G

- Operating Pressure Range 5 to 125 psi
- 40 Micron Element
- 3 Position Non-Rising Adjustment Knob



Air Regulator with Gauge (1/2")
SKU **543091** **74⁹⁹**
ARRR354G

- Adjustment Range is 5 to 125 psig
- Rated for 100 SCFM



NAME	SKU	PART #	PRICE
Regulator with Gauge (3/8")	543088	ARRR353G	74.99

Hoses and Hose Reels

50' Nitrile Rubber Hose 3/8"

- Lays Flat Under Pressure for Easy Maneuverability and Safety
- Meets PFAS-Free Regulations
- Resists Abrasions and Kinks
- UV Protective Material
- Excellent Resistance to Grease, Oil and Weather

SKU **1491310** **64⁹⁹**
LIN72N3850

- 1/4" NPT Brass Fittings

1/2"
SKU **1491309** **89⁹⁹**
LIN72N1250

- 1/2" NPT Brass Fittings



50' Premium Hybrid Hose

- Lightweight Design for Ease of Use and Enhanced Portability
- Kink Resistant with All-Weather Flexibility (-40° to 150°F)

3/8"
SKU **1491308** **59⁹⁹**
LIN72H3850

- 1/4" NPT Brass Fittings

1/2"
SKU **1491307** **89⁹⁹**
LIN72H1250

- 1/2" NPT Brass Fittings



100' Wall Mount Air Hose Reel

SKU **291343** **25970**

44⁹⁹

REG. \$59.99

- Comes with 18" Leader Hose
- Mounts Solid or with Swivel Action
- Solid Steel Frame
- Some Assembly Required

Offer Good Through December 31, 2025



3/8" x 50' Air Hose Reel

SKU **900815** **199⁹⁹**
25979

- Smooth Automatic Retracting Spring Coil
- 50' Hose
- 3/8" NPT Fittings
- Max. Pressure: 250 psi



(Color May Vary)

3/8" x 50' Hybrid Polymer Air Hose with Reel

SKU **347224** **124⁹⁹** REG. \$199.99

SAVE \$75

- Heavy Duty Polymer Hose Material Redefines Flexibility - Stays Flexible Under All Weather Conditions (-40° to 150°F)
- Holds No Memory - Kink Resistant Under Pressure
- 300 psi Working Pressure
- Bend Restriction for Reducing Wear and Tear and Extending Life of Hose
- Solid Brass MNPT Ends



Offer Good Through December 31, 2025

Value Series Air Hose Reel

- Retractable Delivery Hose
- Durable Heavy Gauge Steel Construction
- Slotted Mounting Base for Easy Installation

3/8" x 50'
SKU **972284** **294⁹⁹**
LIN83753

1/2" x 50'
SKU **972285** **319⁹⁹**
LIN83754



3/8" x 50" Retractable Air Hose Reel

SKU **OSB** **209⁹⁹**
LEGL8250FZ

- Extreme All-Weather Flexibility, Even in Subzero Temperatures (-40° to 140°F)
- Won't Kink Under Pressure



For OSB, Call 901-300-4878

Air Chuck

Dual Foot Air Chuck with Comfort Grip Handle

SKU **802201** **24⁹⁹**
24413

- Comfortable Screwdriver Style Handle
- 30° Reverse Angle Chuck Can Be Used on Outside Tires
- Tilt Lock Feature Locks onto the Valve



Air Chuck with Comfort Grip Handle

SKU **802200** **19⁹⁹**
24414

- Durable, OEMTOOLS Screwdriver Style Handle for Comfort and a Positive Grip
- Sealed-Ball Air Chuck is Extended 1" from Handle to Allow Access to Tight Areas



Prices subject to change without notice. Prices do not include applicable taxes, vehicles, tires, rims, installation or optional equipment as shown. Please do not return purchases to the store. For information regarding warranty, repair, or any questions or concerns, call 901-300-4878.

POWER TOOLS

Professional OEMTOOLS®

20V Max* Li-ion
Heavy Duty 1/2" Impact Wrench
SKU 818594 **109⁹⁹**
24481

- Speed: 0 to 2,200 RPM and 0 to 2,900 IPM
- Nut Busting Torque: 300 Ft/Lb.
- Tightening Torque: 260 Ft/Lb.
- Weight: 8 Lb.
- Battery Light Indicators
- Charge Time: 2 Hrs.
- Includes: 4.0Ah Li-ion Rechargeable Battery with Charging Station and Sturdy Blow Mold Storage Case



20V Max* Li-ion
1/2" Brushless Impact Wrench
SKU 592251 **179⁹⁹**
24486

- Variable Speed: 0 to 2,600 RPM and 0 to 3,000 IPM
- Nut Busting Torque: 300 Ft/Lb.
- Tightening Torque: 260 Ft/Lb.
- Charge Time: 2 Hrs.
- Weight: 9.28 Lb.
- Includes: Rechargeable 4.0Ah Li-ion Battery, Charging Station and Sturdy Blow Mold Storage Case



OEMTOOLS®

20V MAX LI-ION

BRUSHLESS MOTOR

20V Max* Li-ion
1/2" Brushless Hammer Drill
SKU 593469 **149⁹⁹**
24485

- Variable Speed: 0-600 RPM and 0-2000 RPM
- Max. Torque: 310 In/Lb.
- Electric Brake
- Clutch: 21 + 1 Torque Setting
- Charge Time: 1 Hour
- Includes: Rechargeable 2.0Ah Li-ion Battery, Charging Station and Sturdy Blow Mold Storage Case



20V Max* Li-ion
Cordless Angle Grinder
SKU 598786 **134⁹⁹**
24492

- Speed: 0 to 10,000 RPM
- Max. Disc Diameter: 4-1/2"
- Spindle Thread: 5/8"
- Spindle Lock: Yes
- Charge Time: 2 Hrs.
- Includes: Grinding Disc, Assist Handle, Rechargeable 4.0Ah Li-ion Rechargeable Battery and Charging Station



20V Max* Li-ion
Reciprocating Saw
SKU 592353 **99⁹⁹**
24491

- Variable Speed: 0 to 3,000 RPM
- Overall Length: 14-1/4"
- Charge Time: 1 Hour
- Includes: High-Quality, Multi-Purpose Bi-Metal Reciprocating Saw Blade, Rechargeable 2.0Ah Li-ion Battery and Charging Station



All Professional OEMTOOLS 20V Power Tools Work with:

Battery Charger
SKU 824778 **49⁹⁹**
27333B

- Replacement Part for OEMTOOLS Heavy Duty 1/2" 2VSR Cordless 20V Li-ion Drill



Replacement Batteries

2.0Ah
SKU 824777 **64⁹⁹**
27333A

4.0Ah
SKU 1236363 **99⁹⁹**
27314AM



*With respect to 20V Max, Maximum initial battery voltage (measured without a workload) is 20 volts. Nominal voltage is 18V.

Corded OEMTOOLS®

Oscillating Tool
SKU 592331 **54⁹⁹**
24495

- Includes: 3-1/2" Semi-Circle Wood Saw Blade, 2" Rigid Scraper, 1-1/4" Wood Plunge Blade, Standard Sanding Pad and (3) 60/80/120 Grit Sandpapers and 6 Ft. Power Cord
- Variable Speed: 11,000 to 20,000 OPM
- Power: 2.3 Amps
- Overall Length: 14-1/2"
- Power Cord Length: 6 Ft.



OEMTOOLS®

7" Variable Speed Polisher
SKU 592258 **79⁹⁹**
24496

- No-Load Speed: 1000 to 3000 RPM
- Power: 11 Amps
- Spindle Thread: 5/8"
- Spindle Lock: Yes
- Power Cord Length: 6 Ft.
- Includes: Sanding Paper, Sanding Pad, Terry Bonnet, Wool Bonnet and Foam Piece



OEMTOOLS®

6" Bench Grinder with Lamp
SKU 412598 **179⁹⁹**
80058

- Solid, Heavy Duty Construction for Shaping and Sharpening Hardened Steel
- 6" Wheels with Tool Rests
- Tool Rests Adjust to 45° or 90° Position
- Includes: Coarse and Fine 6" Grinder Wheels, Goose Neck Lamp, Adjustable Eye Guards and Spark Breakers



OEMTOOLS®

SHARK USA

Bench Grinding Wheel
6" X 3/4" 46 Grit
SKU 112398 **34⁹⁹**
SHA2017

- Economical, Long Lasting Abrasive Wheels



14" Chop Saw
SKU 1228718 **199⁹⁹**
24723 REG. \$239.99

- Ideal for Cutting Wood, Metal, Steel and Pipe
- 15 Amp Motor for Powerful Cutting Action
- Spindle Lock Makes Wheel Changes Quick and Easy
- Accepts Standard 14" Cutoff Discs
- Includes: Cutting Blade and 6 Ft. Power Cord

SAVE \$40



OEMTOOLS®

Offer Good Through December 31, 2025

OEMTOOLS®

20V Max* Li-ion
3/8" Cordless Drill
SKU **052383** **67⁹⁹**
24660

- Chuck Size: 1/2" Keyless Jacob's Chuck
- No-Load Variable 2 Speed Gear Box: 0 to 350 RPM and 0 to 1,150 RPM
- Max. Torque: 220 In/Lb.
- Max. Drilling Capacity: 5/16" (Metal) and 3/4" (Wood)
- Keyless, Auto Spindle Lock Chuck Size: 3/8"
- Clutch: 16 + 1 Torque Clutch Setting
- Electric Brake
- Forward and Reverse Switch
- Battery Charge and Capacity Indicator Lights
- Charge Time: 4 to 6 Hrs.
- Includes: 1.5Ah Li-ion Rechargeable Battery and Battery Charger



20V
MAX*
LI-ION

20V Max* Li-ion
3/8" Cordless Impact Wrench
SKU **052379** **82⁹⁹**
24661

- Anvil: Heat-Treated 3/8" Drive Ball Detent
- Variable Speed: 0 to 2,400 RPM and 0 to 3,000 IPM
- Max. Torque: 200 Ft/Lb. (Forward) and 240 Ft/Lb. (Reverse)
- Battery: 1.5Ah Li-ion
- Electric Brake
- Battery Charge and Capacity Indicator Lights
- Charge Time: 3 to 5 Hrs.
- Includes: 1.5Ah Li-ion Rechargeable Battery and Diagnostic Fast Battery Charger



20V
MAX*
LI-ION

20V Max* Li-ion
1/2" Cordless Impact Wrench
SKU **052380** **99⁹⁹**
24670

- Anvil: 1/2" Square Drive
- Speed: 0 to 2,200 RPM; 0 to 2,700 IPM
- Nut Busting Torque: 300 Ft/Lb.
- Max. Tightening Torque: 240 Ft/Lb.
- Battery: 2.0Ah Li-ion
- Weight: 6.5 Lb.
- Charge Time: 5 to 7 Hrs.
- Includes: 2.0Ah Li-ion Rechargeable Battery, Li-ion Battery Charger



OEM TOOLS®

20V
MAX*
LI-ION

STORE STOCKED

STORE STOCKED

STORE STOCKED

Individual Batteries and Charger Available

20V Max* Li-ion Battery 1.5 Amps
SKU **029415** **45⁹⁹**
24660A

- Charges in 4 to 6 Hrs.

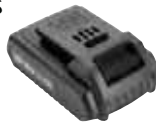

20V Max* Li-ion Battery 2.0 Amps
SKU **1392334** **49⁹⁹**
24670-36

- Charges in 4 to 6 Hrs.



20V Max* Li-ion Battery Charger
SKU **029418** **19⁹⁹**
24660B



4-1/2" Compact Angle Grinder
SKU **052382** **43⁵⁵**
24663

- Motor: 6 Amp
- Voltage: 120V, 60 Hz
- Speed: 10,500 RPM
- Interchangeable Handle for Left or Right Hand Use
- Heavy Duty, Cast Aluminum Gear Head for Strength and Durability
- 6 Ft. Power Cord
- Includes: Grinding Wheel, Spanner Wrench and Disc Guard



Heavy Duty 1/2" Impact Wrench
SKU **052388** **69⁹⁹**
24666

- Input Power: 8.5 Amp
- Voltage: 120V, 60 Hz
- 1/2" Square Drive with Hog Ring Retainer
- No-Load Speed: 0 to 2,200 RPM and 0 to 3,000 IPM
- Replaceable Carbon Brushes
- 8 Ft. Power Cord



STORE STOCKED

STORE STOCKED

Rotary Tool with 35 Piece Accessory Kit
SKU **052384** **37⁹⁹**
24664

- Input Power: 1.2 Amp
- Voltage: 120V, 60 Hz
- No-Load Speed: 10,000 to 35,000 RPM
- Collet Capacity: 1/8" to 3/32"
- Spindle Lock for Easy Bit and Accessory Change
- 6 Ft. Power Cord
- Includes: Grinding Stones, Wheels, Brush, Sanding Bands and Disc, plus Grinding, Cloth and Cut-Off Wheels



Includes 35 Piece Accessory Kit



Flexible Shaft Rotary Tool Extension
SKU **003483** **14⁹⁹**
24657

- Easily Attaches to Many Popular Rotary Tools

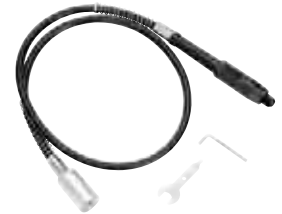

STORE STOCKED

12V Max** Li-ion Power Ratchet
SKU **1069064** **69⁹⁹**
24685

- Max. Torque: 35 Ft./Lb.
- Max. Manual Torque: 96 Ft./Lb.
- No-Load Speed: 230 RPM
- Ergonomic Grip with Low-Profile Head for Work in Tight Spaces
- Features Integrated Worklight for Hard-to-See Spots
- Includes: 2Ah Li-ion Removable Battery and Charger



Dual Temp Heat Gun
SKU **052387** **29⁹⁹**
24665

- Input Power: 10 Amp
- Voltage: 120V, 60 Hz
- Temperature Settings: 482°F/842°F
- Trigger: 3 Position Rocker
- Hanging Loop for Storage
- 6 Ft. Power Cord



STORE STOCKED

STORE STOCKED

*With respect to 20V Max, Maximum initial battery voltage (measured without a workload) is 20 volts. Nominal voltage is 18V.

**With respect to 12V Max, Maximum initial battery voltage (measured without a workload) is 12 volts. Nominal voltage is 10.8V.

Prices subject to change without notice. Prices do not include applicable taxes, vehicles, tires, rims, installation or optional equipment as shown. Please do not return purchases to the store. For information regarding warranty, repair, or any questions or concerns, call 901-300-4878.

POWER TOOLS

Power Tool Accessories

33 Piece
Impact Rated Driving
Bit Set

SKU 750443 25960 **14⁹⁹**



- Designed to Withstand High Torque Applications
- Reduces Wear, Stripping and Cam-Out
- Includes: Magnetic Impact Rated Bit Adapter



6 Piece Bi-Metal
Hole Saw Set

SKU 547011 24378 **24⁹⁹** REG. \$39.99

SAVE \$15

- Includes: Sizes: 7/8", 1", 1-1/8", 1-1/4" and 1-1/2" (22 mm, 25 mm, 29 mm, 32 mm and 38 mm)
- Slotted Saw Allows for Easier Plug Removal
- Durable Enamel Finish Protects Against Corrosion
- Bi-Metal Construction for Increased Wear Resistance



Offer Good Through December 31, 2025

OEM TOOLS

Multi-Purpose Drill
Powered Pump

SKU 526513 24503 **29⁹⁹**

- Works with a Corded or Cordless Drill to Transfer the Following Liquids: Fresh Water, Sea Water, Organic Solvents, Motor Oil, Heating Oil, Insecticides and Liquid Fertilizers



Bench Grinder,
Vise and Drill
Press Stand

SKU 943120 24643 **164⁹⁹**

- Heavy Duty Steel Construction Features Large Base to Prevent Walking or Wobbling During Operation and is Pre-Drilled for Mounting
- Top/Plate Dimensions: 13.8"(L) x 9.8"(W) x 0.2"(H)
- Overall Dimensions: 13.8"(L) x 9.8"(W) x 37.4"(H)

Multiple Mounting Configurations Fit Many Bench Grinders, Pipe Benders, Vises and Drill Presses



4-1/2" x 1/16" x 7/8"
Cut Off Wheel
Pack of 6

SKU 1485031 26510PK **19⁹⁹**

OEM TOOLS

- 4-1/2" Wheel Diameter
- 1/16" Wheel Thickness
- 7/8" Arbor Diameter
- Will Evenly Cut Through Fiberglass, Plastic and Steel
- Arbor Diameter Fits Most Drills



3 Piece Spiral Step Drill Set

SKU 99189 24372 **29⁹⁹**

OEM TOOLS

- Titanium Two-Flute Spiral for Longer Life, Faster Drilling and Less Vibration
- Split Point Generates Less Heat
- Bit One: 13 Sizes from 1/8" to 1/2"
- Bit Two: 6 Sizes from 3/16" to 1/2"
- Bit Three: 9 Sizes from 1/4" to 3/4"
- 28 Hole Sizes in 3 Bits
- Enlarge Existing Holes
- 1/4" Hex Shank To Prevent Slipping in Chuck Applicable Materials: Stainless Steel, Copper, Brass, Aluminum, Plastic and Laminates (Material Thickness of 0.125")



4.5" Depressed Center
Grinding Wheels

SKU 1485045 SHA12734 **14⁹⁹**

- Type 27 Aluminum Oxide Grinding Wheels
- Arbor: 7/8"
- Diameter: 4.5 by 1/4"
- Hubless, 24 Grit
- Pack Contains 3 Wheels



SHARK USA

Mechanics Set

SKU 533204 | 24974

1,999⁹⁹ REG. \$2,355.51

SAVE \$355

Includes 156 of the Most Common Tools in Tool Cart

- SAE and Metric, 1/4", 3/8" and 1/2" Drive Tools, Combination Wrench Sets, Pliers and Screwdrivers. Plus Battery Service Tools, Oil Change Tools and More



Go to AZTOOL1.com for 24974 Contents List

Cart Style and Color May Vary

Offer Good While Supplies Last Through December 31, 2025

Technicians Set

SKU 533203 | 24975

2,649⁹⁹ REG. \$3,203.22

SAVE \$553

Includes 312 of the Most Common Tools in Tool Cart

- SAE and Metric, 1/4", 3/8" and 1/2" Drive Tools, Combination Wrench Sets, Pliers and Screwdrivers. Plus Battery Service Tools, Oil Change, Wheel Service and More



Go to AZTOOL1.com for 24975 Contents List

Cart Style and Color May Vary

Offer Good While Supplies Last Through December 31, 2025

JACKS & HYDRAULICS

TO ORDER, contact your Commercial Sales Manager or go to AutoZonePro.com

JACKS & HYDRAULICS

Floor Jacks

2 Ton Off-Road Jack

SKU 1525571 **374⁹⁹**
29004

- Full Length Skid Plate Provides Stability in Soft or Unstable Materials Such as Sand or Gravel
- Heavy Duty Oversized Wheels are Ideal for Navigating on Rough or Uneven Surfaces
- High Lift Adapter Extension for Additional Lift Height Up to 24-3/16" Provides Access to Lifting Points for Off Road Vehicles
- Dual Piston Hydraulic System for Quicker, More Efficient Lifting
- Min. Height without Extension: 6-1/8", with Extension Stage: 11-1/4"
- Max. Height without Extension: 17-15/16", with Extension Stage: 24-3/16"
- Weight: 59.5 Lb.



Secure Lock Detent for Safety and Comfort During Transportation and Operation



24 3/16"
MAX ↑
HEIGHT



Heavy Duty Oversized Wheels



Carry Handle for Portability



Locking Adjustable Height Extender

4 Ton Hydraulic Service Jack

SKU 1525558 **324⁹⁹**
29003

- Dual Piston Hydraulic System for Quicker More Efficient Lifting
- Nylon Casters Protect Sealed Floor Surfaces and Dealer Showrooms
- Meets ASME PASE-2019 Standards
- 4.3" Saddle Provides Generous Lifting Area and Secure Grip
- Min. Height: 4-3/8"
- Max. Height: 20-1/4"
- Weight: 98.3 Lb.

20 1/4"
MAX ↑
HEIGHT



3-1/2 Ton Low Profile Floor Jack

SKU 757109 **399⁹⁹**
24837

- Dual Pump Design for Quicker Lifting
- Min. Height: 3-3/4"
- Max. Height: 20-1/2"
- Length: 27-1/8"
- Weight: 85.8 Lb.

3 3/4"
LOW ↓
PROFILE



3 Ton Long/Low Signature Service Jack

SKU 1407611 **329⁹⁹**
24868

- Extra Long and Low Profile is Great for Low Clearance Vehicles, Pickups and SUVs
- Padded Jack Handle and Saddle Pad to Prevent Vehicle Damage
- Dual Pump Design for Quicker Lifting
- Nylon Casters to Protect Sealed Floor Surfaces and Dealer Showrooms
- Min. Height: 3-3/8"
- Max. Height: 24-1/4"
- Length: 31-3/8"
- Weight: 100.3 Lb.

3 3/8"
LOW ↓
PROFILE



3 Ton Low Profile Jack

SKU OSB **249⁹⁹**
29005

- Low Profile Professional Quality Floor Jack for Low Clearance Vehicles
- 3-1/8" Minimum Height is Ideal for Sports Cars, Lowered Vehicles, and Lifting Vehicles with Flat Tires
- 4.3" Saddle with Jack Support Pad and Foam Handle Cover to Prevent Damaging Vehicle
- Overload and Bypass Safety Valves Prevent Use Beyond Rated Capacity and Over-Extension
- Weight: 73.7 Lb.

3 1/8"
LOW ↓
PROFILE



Ideal for Sports Cars, Lowered Vehicles, and Lifting Vehicles with Flat Tires



For OSB, Call 901-300-4878

2-1/2 Ton Aluminum/Steel Hybrid Floor Jack

SKU 1417557 **329⁹⁹**
24869

- Aluminum and Steel Frame Construction Provides the Benefit of Strength Along with Light Weight
- Padded Jack Handle and Saddle Pad to Prevent Damage to Vehicle
- Dual Pump Design for Quicker Lifting
- Nylon Casters to Protect Sealed Floor Surfaces and Dealer Showrooms
- Min. Height: 3-1/2"
- Max. Height: 19-1/4"
- Length: 25-1/2"
- Weight: 58.2 Lb.

3 1/2"
LOW ↓
PROFILE



2 Ton Extra Long, Extra Low Profile Floor Jack

SKU 757041 **474⁹⁹**
24838

- Min. Height: 2-3/4"
- Max. Height: 24-1/4"
- Length: 31-7/8"
- Weight: 97.5 Lb.

2 3/4"
LOW ↓
PROFILE



All OEMTOOLS® Jacks on this page include overload and bypass safety valves and meet ASME PASE 2014 Safety Standards.

Prices subject to change without notice. Prices do not include applicable taxes, vehicles, tires, rims, installation or optional equipment as shown. Please do not return purchases to the store. For information regarding warranty, repair, or any questions or concerns, call 901-300-4878.

AZG0425

JACKS & HYDRAULICS

Wheel Dollies

Mechanical Vehicle Position Dollies

- Easily Lift and Move Vehicles Up to 6,000 Lb.
- 1,500 Lb. Capacity Each

Set of 2 Dollies

SKU 1089031
24793

399⁹⁹



Set of 4 Dollies with Storage Cradle

SKU 1414391
69000

649⁹⁹

REG. \$809.97

SAVE OVER **\$159**

When You Buy the Set



OEM TOOLS®

Hydraulic Vehicle Position Dollies

- Easily Lift and Move Vehicles Up to 6,000 Lb.
- 1,500 Lb. Capacity Each

Set of 2 Dollies

SKU 298098
24855TWO

474⁹⁹



Set of 4 Dollies with Storage Cradle

SKU 696485
68986

749⁹⁹

REG. \$909.97

SAVE OVER **\$159**

When You Buy the Set



1500 Lb. Wheel Dollies Set

SKU 757043
24858

99⁹⁹
REG. \$119.99

SAVE **\$20**

- Great for Moving Cars, Trucks, Trailers and Lawn Tractors
- 4 Swivel Nylon Casters Give Mobility in All Directions, Roll Smoothly and are Safe for Epoxy Floors
- HD Steel Plate Construction for a Long Life
- 2 Casters on Each Dolly Have Locking Mechanisms

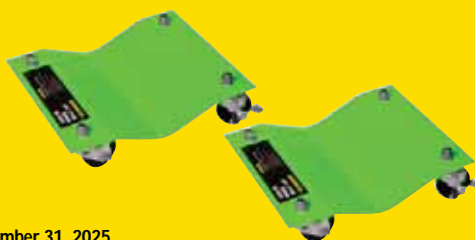

Offer Good While Supplies Last Through December 31, 2025

Vehicle Position Dolly Cradle

SKU 544800
24856

99⁹⁹

- Neatly Secure and Store Up to 4 Vehicle Car Dolly Jacks



Price does not include jacks

Air Hydraulic Jacks

OEM TOOLS®

20 Ton Air Hydraulic Bottle Jack

SKU 544795
24850

224⁹⁹

- Can Be Operated with Air or Manually
- Height: 10.25" to 20.1"
- Extension Screw Adjustment: 3.15"
- Meets or Exceeds ASME PASE-2019 Standards



22 Ton Air Hydraulic Truck Jack

SKU 544796
24851

899⁹⁹

- Compact, Low Profile Design Easily and Safely Fits Between Wheels of Tandem Axle Vehicles
- Ram Travel: 4-15/16"
- Extension Screw Adjustment: 4"
- Min. Height: 8-3/4"
- Max. Height: 17-11/16"



Hydraulic Jacks Built for Performance and Ease of Use

Lift Pads

OEM TOOLS®

Tesla Jack Pads Models 3/S/X/Y

SKU 1580896
28999

29⁹⁹

NEW

- For Tesla Models 3, S, X and Y
- One-Piece Molded Rubber Construction is Sturdy and Durable
- O-Ring Allows the Adapter to be Pre-Installed onto the Vehicle
- For Use With Floor Jack or 2-Post Lift
- Prevents Damage to the Battery Pack
- 4 Adapters and Storage Case



Jack Stands

3 Ton Jack Stands (Pair)

SKU 757122
24852

59⁹⁹
REG. \$99.99

SAVE **\$40**

- Min. Height: 11"
- Max. Height: 16-1/2"
- Meets or Exceeds ASME PASE-2019 Standards



Offer Good While Supplies Last Through December 31, 2025

6 Ton Jack Stands (Pair)

SKU 1580891
24788

99⁹⁹

NEW

- Large Welded Foot Pads Provide Extra Stability and Resist Sinking into Asphalt and Similar Surfaces
- Recessed Saddle for a Secure Placement
- Self-Locking Ratchet Allows Safe and Easy Adjustment
- Features Locking Pin for Additional Security When Under Load
- Max. Height: 23-7/16"
- Min. Height: 15-1/2"
- Meets or Exceeds ASME PASE Standards



22 Ton Heavy Duty Axle Stands (Pair)

SKU 757098
24854

249⁹⁹

OEM TOOLS®

- Min. Height: 12-1/4"
- Max. Height: 19-3/4"
- Adjustable Pin Design
- Features Handle for Transport and Positioning
- Large V-Shaped Saddles Center Lift Points for Secure Placement
- Meets or Exceeds ASME PASE-2019 Standards



JACKS & HYDRAULICS

TO ORDER, contact your Commercial Sales Manager or go to AutoZonePro.com

JACKS & HYDRAULICS

Transmission Jacks

1,000 Lb. Telescopic Transmission Jack

SKU 544786
24840

249⁹⁹

- Load Capacity: 1,000 Lb.
- Lowered Height: 51"
- Raised Height: 70"
- 2-Way Adjustable Saddle
- Heavy Duty Ram with Controlled Release Feature



70" REACH

1,100 Lb. High Lift Transmission Jack with Foot Pump

SKU 750006
24844

449⁹⁹

- Load Capacity: 1,100 Lb.
- Lowered Height: 47"
- Raised Height: 79"
- 4-Way Adjustable Saddle
- Spring-Loaded Release Valve Stops Lowering When You Let Go

Foot Pedal Pump and Release for Hands-Free Operation



79" REACH

1,100 Lb. 2 Stage Telescoping Transmission Jack

SKU 1089028
24790

999⁹⁹

- Second Stage Capacity: 1,100 Lb.
- Lowered Height: 37"
- Raised Height: 76.4"
- 4-Way Adjustable Saddle
- Fast Lifting Pump

Foot Pedal Pump and Release for Hands-Free Operation

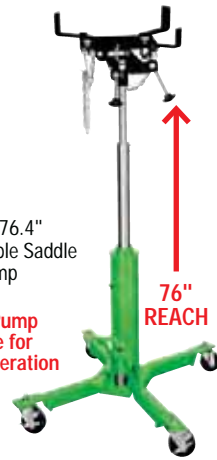

76" REACH

1 Ton 2 Stage Telescoping Transmission Jack

SKU 1142678
26842

1,099⁹⁹

- Second Stage Capacity: 2,000 Lb.
- Lowered Height: 37.5"
- Raised Height: 76"
- 4-Way Adjustable Saddle
- Internal Shaft Retention to Prevent Leaks and Dirt Intrusion

Foot Pedal Pump and Release for Hands-Free Operation



76" REACH

800 Lb. Low-Profile Transmission Jack

SKU 544789
24845

474⁹⁹

- Fully Adjustable Saddle Adapts to Most Transmission Pans
- Swivel Saddle Adjusts Both Directions
- Meets ANSI 2014 Standards
- Lowered Height: 8.5"
- Raised Height: 24.5"

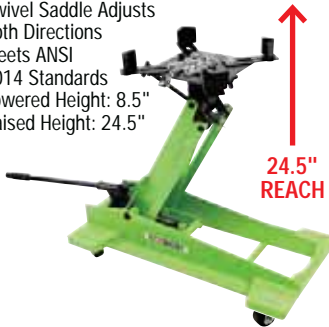

24.5" REACH

1/2 Ton Transmission Jack

SKU 902478
RANRTJ1100

649⁹⁹

- Lifting Capacity: 1,100 Lb.
- Lowered Height: 45"
- Raised Height: 72"



72" REACH

1 Ton Telescoping Transjak™ Transmission Jack

SKU OSB
RANRTJ1

949⁹⁹

- Capacity First Stage: 2,000 Lb.
- Capacity Second Stage: 1,000 Lb.
- Lowered Height: 37"
- Raised Height: 71"

For OSB, Call 901-300-4878



71" REACH

1-1/2 Ton Telescoping Transmission Jack

SKU OSB
RANRTJ3000

999⁹⁹

- Capacity First Stage: 3,000 Lb.
- Capacity Second Stage: 2,000 Lb.
- Lowered Height: 35-1/2"
- Raised Height: 71-1/2"

For OSB, Call 901-300-4878



71-1/2" REACH

1,100 Lb. Manual Transmission Jack

SKU 954229
AFF3052

1,599⁹⁹

- 2 Stage Telescopic Ram Designed for Medium Truck Transmissions, Transfer Cases and Differentials
- Chrome Plated Pump Core and Piston Rod Reduces Friction and Provides Long Service Life
- Powder Coat Finish Provides Resistance to Corrosion, Chemicals and Scratches
- Adjustable Saddle with Corner Bracket and Safety Chain
- Double Pump Hydraulic System for Quick Lift Operation
- Adheres to ASME 2014



78" REACH

1,100 Lb. Air Assist Transmission Jack

SKU 954225
AFF3052A

1,699⁹⁹

- 2 Stage Telescopic Ram Designed for Medium Truck Transmissions, Transfer Cases and Differentials
- Chrome Plated Pump Core and Piston Rod Reduces Friction and Provides Long Service Life
- Powder Coat Finish Provides Resistance to Corrosion, Chemicals and Scratches
- Adjustable Saddle with Corner Bracket and Safety Chain
- Double Pump Hydraulic System for Quick Lift Operation
- Adheres to ASME 2014



78" REACH

You May Also Need

Fuel Tank Adapter

SKU 1407554
24832

199⁹⁹

- Makes Fuel Tank Removal Safe and Easy
- Works with Most Transmission Jacks
- Includes: 2 Nylon Straps to Secure Tank
- Foam Rubber Pads Protect Tank

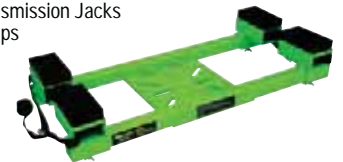

Transmission Drain Pan

SKU 908383
87035

39⁹⁹

- Flexible Plastic Construction Fits on Top of Funnels for Most Lift Drains
- Built-In Screen to Catch Debris, Parts and Tools
- Dimensions: 22-3/4" (L) x 23-3/4" (W) x 4-3/4" (H)



Prices subject to change without notice. Prices do not include applicable taxes, vehicles, tires, rims, installation or optional equipment as shown. Please do not return purchases to the store. For information regarding warranty, repair, or any questions or concerns, call 901-300-4878.

JACKS & HYDRAULICS

Engine Stands

1,250 Lb. Engine Stand
SKU **462493** **299⁹⁹**
24829

- Easy to Move and Rotate
- Heavy Gauge Square Steel Tube Frame
- Extra Wide 4 Wheel Base Provides Added Stability
- 360° Rotation
- Lock Pin Locks Engine into Position



Heavy Duty 1,000 Lb. Engine Stand
SKU **757115** **229⁹⁹**
24839

- Adjustable Mounting Arms to Fit Most Engine Configurations
- Locking Head Plate with 360° Engine Rotation
- Tubular Steel Construction
- Base: 32-1/2" (L) x 30-3/4" (W)
- Height: 37-3/8"
- Weight: 41.9 Lb.



1,100 Lb. Rotating Engine Stand
SKU **1125862** **649⁹⁹**
24798

- Adjustable Mounting Arms to Fit Most Engine Configurations
- Locking Head Plate with 360° Engine Rotation
- Heavy Duty Worm Gear for Effortless Rotation
- Tubular Steel Construction
- Folding Legs for Easy Storage
- Base: 41-1/4" (L) x 27-1/8" (W)
- Weight: 102.5 Lb.



1 Ton Folding Engine Stand
SKU **544804** **329⁹⁹**
24834

- Folds Upright to Conserve Valuable Floor Space
- Sturdy, Wide-Base Design to Prevent Tipping Under Load



Shop Cranes

6,000 Lb. Heavy Duty Engine Crane
SKU **1267948** **1,579⁹⁹**
AFF3584

- Reinforced Leg Assemblies for Added Strength and Durability
- 4 Different Boom Settings: 3, 2, 1.5 and 1 Ton
- Rear of Crane: 61.5" Tall x 33" Wide
- Distance Between Front of Legs: Retracted 23", Extended 28.5"
- Built-In Safety Overload to Protect the Unit from Being Used Beyond its Rated Capacity



2 Ton Folding Shop Crane
SKU **OSB** **649⁹⁹**
RANRSC2TF

- Heavy Duty Hydraulic Folding Engine Hoist with 2 Ton Capacity Ram is Perfect for Shops That Have Limited Space but Still Need the Pure Lifting Convenience of a Crane
- Front Casters Include a Safety Brake to Prevent Movement



2 Ton Folding Shop Crane
SKU **544801** **624⁹⁹**
24830

- Foldable Design Makes for Convenient, Easy Storage
- 6 Solid Steel Caster Wheels Add Mobility
- Fully Adjustable 4 Position Boom



Lifting Accessories

Universal Engine Lift Plate
1,000 Lb. Capacity
SKU **662861** **24⁹⁹**
24867

- Corrosion Resistant, Gold Iridite Zinc Plating
- Tough, All Steel Construction
- Fits Most Style 6 and 8 Cylinder Engines with 2 or 4 Barrel Intake Manifolds
- Mounting Hardware Not Included



Floor Jack Crossbeam
SKU **544803** **99⁹⁹** REG. \$174.99
24833

- Compatible with Most Floor Jacks with a 1-1/8" Diameter Saddle Stud
- Saddles Adjust from 23" to 32" on Center
- Min. Width Capacity: 3,000 Lb.
- Max. Width Capacity: 4,000 Lb.



Offer Good Through December 31, 2025



SAVE \$75

Fuel Tank Adapter
SKU **222503** **169⁹⁹**
DOWJDI-FTA7

- Safe and Convenient Adapter for Handling Vehicle Fuel Tanks
- Works with Most Transmission Jacks



Bed Lifter
SKU **OSB** **339⁹⁹**
STK35885

- Designed to Lift Truck Beds Safely and Easily
- Lifting Brackets Adjusts to Evenly Distribute Weight



Ideal for Fuel Pump Replacement



For OSB, Call 901-300-4878

JACKS & HYDRAULICS

TO ORDER, contact your Commercial Sales Manager or go to AutoZonePro.com

JACKS & HYDRAULICS

Engine Support

3 Point Engine Support Bar
SKU **133617** **129⁹⁹**
24951

- Makes Removal of Transaxle Easy by Supporting Engine of Front Wheel Drive Vehicles
- Width Expands from 34-1/2" to 61"
- (2) 14" Adjustable Hook Screws
- (2) 38" Braided Steel Cables
- 700 Lb. Capacity



1,100 Lb. Engine Support
SKU **512946** **174⁹⁹**
24950

- 2 Screw Adjusters for Precise Positioning Makes Job Easier, Faster and Safer
- Rubber Feet to Prevent Damage to Vehicle and Ensure Stability
- 1,100 Lb. Capacity



3/4 Ton Engine Leveler
SKU **544802** **59⁹⁹**
24831

- 4 Point Mounting System Provides Maximum Control
- 3 Chain Positions to Accommodate Different Engine Configurations
- Durable Steel Construction
- Smooth Operating Worm Drive Shaft for Easy Level Adjustment
- Rated Capacity: 1,500 Lb.

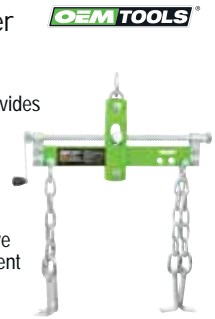

Lift Table

OEM TOOLS®

660 Lb. Double-Scissor Lifting Table Cart
SKU **1525568** **799⁹⁹**
24789

- Reduces Operator Strain When Moving Heavy or Bulky Items
- Double Scissor Mechanism Raises the Table from 13.8" to 50.6"
- Large 32" x 20" Platform Fits a Wide Range of Items
- Foot Pedal Pump Allows Hands-Free Operation
- Hand Operated Release Lever for Easy, Controlled Descent
- 5" Heavy Duty Casters with Bearings for Easy Rolling Over Rough Floors
- Safety Bar Lock Mechanism Allows the Table to Be Secured at 40.2"
- All Steel Construction for Strength and Durability



High Reach Stands

OEM TOOLS®

- Provides Added Support During Installation/Removal of Automotive Components
- Compact Design for Use in Limited Workspaces
- Durable Heavy Gauge Steel Construction

1,500 Lb. High Reach Jack Stand
SKU **757043** **169⁹⁹**
24848

- Min. Height: 55"
- Max. Height: 78"
- Meets or Exceeds ASME PASE-2019 Standards



1,500 Lb. High Reach Jack Stand with Foot Pedal
SKU **757078** **199⁹⁹**
24847

- Foot Pedal Pump Saves Time Adjusting Load
- Min. Height: 55"
- Max. Height: 78"
- Meets or Exceeds ASME PASE-2019 Standards



2 Ton Underhoist Tripod Jack Stand
SKU **757084** **199⁹⁹**
24849

- Adjustment Pin Securely Supports Load in 5 Positions
- Min. Height: 49"
- Max. Height: 80"
- Meets or Exceeds ASME PASE-2019 Standards



Powertrain Lifts

CL Challenger Lifts

EV Lift Table
SKU **OSB** **12,399⁹⁹**
CHLBT3300

- 3,300 Lb. Lift Capacity
- Scissor-Style Lifting
- Hydraulic Cylinder and 115V Plug
- Pendant Controlled Operation
- Max. Reachable Height: 76.5"
- Complies with ASME PASE-2019
- 8" Clearance Under Base Plate for Battery Removal
- Extending, Adjusting and Tilting Top Plate for Larger Batteries



2,500 Lb. Powertrain Lift
SKU **OSB** **6,349⁹⁹**
AFF3182

- Air Assist Foot Pump with 9' Extension Provides Hands-Free Operation
- Safety Latches at 30%, 50% and 80% of Max. Height
- 8" Diameter Swivel Casters for Easy Maneuverability
- Rear Wheels Can Be Locked to Prevent Rolling
- Table Top Height from 33" to 77"

AFF



4,500 Lb. BendPak® EV Battery and Powertrain Lift Table
SKU **OSB** **10,199⁹⁹**
BENEVS4500

- Full-Rise Battery Powered Mobile Scissor Lift Table
- Remote Control Operation
- DC Electric Power System with Onboard Charging
- Full-Length Utility Trays



2,200 Lb. Lifting Table, Air/Hydraulic with Adapters
SKU **OSB** **3,999⁹⁹**
CEA-MS10KIT

- Designed for Removing/Replacing Battery Packs of Electric Vehicles as well as the Engine, Transmission, Drive Axle, Fuel Tank, Suspension and Sub-Frames of Traditional Vehicles
- Large Base Frame Ensures Better Stability and Reliability
- Max. Lift: 70-1/16"
- Min. Height: 22-7/16"
- Platform Length: 51-3/8" to 58-1/4"
- Platform Width: 33-1/8"



2,640 Lb. Lifting Table, Electric/Hydraulic with Adapters
SKU **OSB** **6,499⁹⁹**
CEA-MS12MKIT

CUTTING EDGE

To Confirm Price, Availability and Ordering Instructions on OSB, Call 901-300-4878

Prices subject to change without notice. Prices do not include applicable taxes, vehicles, tires, rims, installation or optional equipment as shown. Please do not return purchases to the store. For information regarding warranty, repair, or any questions or concerns, call 901-300-4878.

ALIGNMENT

Ask About Special Pricing on Additional Multi-Lifts and Package Deals, Call 901-300-4878

SAVE \$1,549*

geoliner® 609 with 12K 4-Post Lift

SKU **OSB**
ALIGNCOMB020 33,199⁹⁹

- Provides Accurate, Real-time Measurements - Reduces Setup and Measurement Times While Generating Serious Productivity Benefits
- Ultra Low-Profile Design Allows Easy-On Approach Angle for Low Profile Vehicles
- Hydraulic Cylinder Mounted Underneath Runway
- Closed Front Design



HOFEWA741TH3

HOFEELR728APKG

**Hofmann Will Pay \$750
Towards Your Lift Install.**
(Must use Hofmann authorized installer.)

* Savings based on the price of items if purchased separately and includes lift install credit.

ALIGNER INCLUDES: Manufacturer's Set-Up

INCLUDES: (2) Rolling Jacks, Air Line Kit, Premium Turn Plates and Rollback Kit

WARRANTY: 1 Year Parts and Labor

SAVE \$2,849*

geoliner® 678 Complete Alignment System with 12,000 Lb. Scissor Lift

SKU **OSB**
ALIGNCOMB026 56,399⁹⁹

- Includes: Geoliner® 678 Aligner w/AC400 Clamps and VIN Reader, 12,000 Lb. Scissor Lift with (2) Rolling Jacks, Air Line Kit, Turn Plates and Rollback Kit
- Open Front Design Provides Easy Access to Alignment Service and Calibration Areas
- 24" Wide Runways Provide Easy Drive-On for Large Vehicles
- 70" Lifting Height

HOFMANN



HOFR709APKG



HOFA715TBV3

Hofmann Will Pay \$1,500 Towards Your Lift Install.
(Must use Hofmann authorized installer.)

* Savings based on the price of items if purchased separately and includes lift install credit.

SAVE \$1,299*

4 Post Alignment Lift Package (Open-Front)

SKU **OSB**
BEN14AXCOMB3 16,899⁹⁹

- 14,000 Lb. Lift Capacity
- Overall Length: 243"
- Runway Width: 20.5"
- Includes: Lift, (2) 7,000 Lb. Rolling Jacks, Turn Plates, Slip Plates and Air Line Kit



* Savings based on the price of items if purchased separately.

INCLUDES: (2) Rolling Jacks, Turn Plates, Slip Plates and Air Line Kit

SAVE \$1,199*

4 Post Alignment Lift Package

SKU **OSB**
BEN14LSXECMB2 15,349⁹⁹

- 14,000 Lb Lift Capacity
- Overall Length: 271"
- Runway Width: 20"
- Includes: Lift, (2) 7,000 Lb. Rolling Jacks, Turn Plates, Slip Plates and Air Line Kit

BendPak



* Savings based on the price of items if purchased separately.

WARRANTY: 1 Year Parts and Labor



Customer Responsible For Offloading, Liftgate Service Available.

For OSB, Call 901-300-4878

• Free Delivery in 48 Continental United States • Specifications Subject to Change without Notice or Liability • Equipment Lead Times and Shipping May Vary • Customers Responsible for Offloading Equipment Upon Arrival • Leasing Terms Available, Ask Your AutoZone® Commercial Sales Manager.

ALIGNMENT

FOR HELP with Selection, Confirm Availability and Ordering Instructions, Call 901-300-4878

ALIGNMENT

Aligners

geoliner® 770 AC400 Clamps and VIN Reader

SKU **OSB**
HOFEEWA752BV3 **31,599⁹⁹**

- Lightweight, 3-Camera System Folds to a Compact Size with a Low Center of Gravity, Taking Up Less Floor Space in the Shop and Easily Maneuverable When Needed
- Touchless AC400 Wheel Clamping System (Only the Tire is Contacted), Installed in Seconds with a Single, Fast-Action Adjustment Knob
- Automatic Height Tracking to Provide Optimum Placement of its Advanced XD Targets and Cameras for More Speed and More Accuracy on Every Alignment
- Diagnostic Alignment with "Compensate Warn Alert" Intervention Gets it Right the First Time
- Video Speed Cameras Constantly Monitor Alignments, Providing Information at Every Step
- Unique Camera Beam Design Fits Through a Standard Doorway and Protects Cameras
- Next Generation UI Optimized for the High Volume User
- Highly Accurate and Reliable XD Camera Technology



Made in USA

ALIGNER INCLUDES:
Manufacturer's Set-Up

WARRANTY:
1 Year Motor and Parts, 6 Months Labor,
3 Years Circuit Boards, Pods and Electronics

HOFMANN®

geoliner® 609 Alignment System

SKU **OSB**
HOFEEWA741TH3
14,849⁹⁹

- Groundbreaking User Interface Provides Instant Access to Critical Tasks
- No Calibrations Required
- Designed for a Connected World
- Small Footprint
- Includes:
AC200 Clamps

WARRANTY:
1 Year Motor and Parts,
6 Months Labor,
3 Years Circuit Boards,
Pods and Electronics

ALIGNER INCLUDES:
Manufacturer's Set-Up



Made in USA

geoliner® 660 Imaging Wheel Aligner

SKU **OSB**
HOFEEWA712TH3 **23,199⁹⁹**

- Advanced XD Cameras and Sophisticated Monitoring Algorithms
- Exclusive Dimensioning and Productivity Features
- Patented EZ-TOE – Turn the Front Wheels and Access Difficult Adjustment Points While Still Displaying Centered Toe Readings
- Features Easy-Rolling Casters, Storage for All Attachments and a Fully Enclosed Printer Compartment
- Includes AC200 Clamps, Brake Pedal Depressor, Color Ink-Jet Printer and Steering Wheel Holder



Made in USA

WARRANTY:
1 Year Motor and Parts, 6 Months Labor,
3 Years Circuit Boards, Pods and Electronics

ALIGNER INCLUDES:
Manufacturer's Set-Up

geoliner® 678 Wheel Alignment System with AC400 and VIN

SKU **OSB**
HOFA715TBV3 **28,949⁹⁹**

- Easy to Use Interface - 3 Levels of Intervention ("Compensate – Warn – Alert") with Corrective Actions Just One Click Away
- Help Videos - View Detailed Videos of How to Make Needed Adjustments to Complete Even the Most Complex Tasks
- Cross-Diagonal Measurements Identify Frame or Structural Damage (Saving Time)
- Rolling Radius Identifies Mismatched Tire Sizes to Prevent Vehicle Pulling and Drive Train Damage
- Touchless AC400 Wheel Clamping System (Only the Tire is Contacted), Installed in Seconds with a Single Fast-Action Adjustment Knob

WARRANTY:
1 Year Motor and Parts, 6 Months Labor,
3 Years Circuit Boards, Pods and Electronics

ALIGNER INCLUDES:
Manufacturer's Set-Up



Made in USA

Alignment Accessories

Steel Turn Plates

SKU **OSB**
QSP25-140
Call for Price

- Capacity: 4,500 Lb. per Plate
- Dimensions: 14" x 14" x 1.5"



Stainless Steel Turn Plates

SKU **OSB**
QSP25-129
Call for Price



Made in USA

Rear Slip Plate Add-On Kit

SKU **OSB**
QSPDB-6000
Call for Price

- (2) 59-1/2" x 20" Full Floating Rear Slip Plates
- Simple Installation On Most General Service Lifts
- Length Options: 173", 186" to 196" and 200" to 205"
- Turn Plates Not Included



Made in USA

Steering Wheel Holder and Pedal Depressor Kit

SKU **802195**
24231 **124⁹⁹**

- Holds Steering Wheel in Position for Alignment Adjustments
- Depresses Brake Pedal for Various Brake Checks Including Brake Lamp Operation
- Simply Hand Squeeze the Actuator to Accomplish Fine Adjustments



For Pricing, Call Your Commercial Sales Manager



Customer Responsible For Offloading.

For OSB, Call 901-300-4878

- Free Delivery in 48 Continental United States
- Specifications Subject to Change without Notice or Liability
- Equipment Lead Times and Shipping May Vary
- Customers Responsible for Offloading Equipment Upon Arrival
- Leasing Terms Available, Ask Your AutoZone® Commercial Sales Manager.

Prices subject to change without notice. Prices do not include applicable taxes, vehicles, tires, rims, installation or optional equipment as shown. Please do not return purchases to the store. For information regarding warranty, repair, or any questions or concerns, call 901-300-4878.

AZG0425

87

ALIGNMENT

Aligners

CWA 6500 Wheel Aligner
 SKU **OSB** **AMM8006500** **28,649⁹⁹**

- Comes with Both Self-Centering Clamp and Exclusive Tire Gripping Adapters to Ensure Both Accurate Reading and Fast Operation
- Multiple Compensation Modes to Make Getting Readings on Heavy Vehicles Easy without Having to Roll Vehicle Excessively Far
- Two Wheel Alignment Mode for Setting Total Tow on Large Trucks, No Rear Targets Required
- Standard VIN Scanner for Time Savings and Ease of Vehicle Selection
- Mobile Cabinet Supports Using Aligner in Multiple Bays



COATS

ALIGNER INCLUDES:
 Manufacturer's Set-Up and Training

WARRANTY:
 1 Year Parts,
 6 Months Labor, 30 Days Wheel Clamps

Mobile Tablet Aligner
 SKU **OSB** **ROTR1065** **11,749⁹⁹**

- Tablet Operated
 No PC Required
- Wifi Communication
 No Cables
- 4 Sensors
 2CCD Cameras Each
- Sensor Cart Charging
 Built-In
- 4 Point Clamps



Rotary

ALIGNER INCLUDES:
 Manufacturer's Set-Up

WARRANTY:
 3 Years Parts and
 1 Year Labor

CEMB Wheel Alignment Systems

- User Friendly Software with Adjustment Graphics
- More Than 55,000 Vehicles In Database
- Cloud Based Wi-Fi Networking
- 12" to 24.5" Clamping Range
- For Cars and Light Trucks

CEMB USA
 WHEEL SERVICE EQUIPMENT

Trolley Wheel Alignment System

SKU **OSB** **CMBDWA1100TROLL**
12,799⁹⁹

- Toughpad with 10" Touch Screen,
 Waterproof, Dustproof Rubberized Case



CMBDWA1100TROLL

Complete Wheel Alignment System

SKU **OSB** **CMBDWA1100CWAS**
18,499⁹⁹

- Portable Wheel Stands with Integral Turn Plates on All Four Stands Align All Vehicles
- Stands Weight Limit: 10,000 Lb. or 2,500 Lb. per Stand
- Includes: Stands, Roller and Plates

Wheel Alignment System

SKU **OSB** **CMBDWA1100**
15,899⁹⁹

- Includes: Cabinet, Printer, Depressor, Holder and Software

ALIGNER INCLUDES:
 Manufacturer's Set-Up and Training

WARRANTY:
 2 Years Parts, 1 Year Labor

DWA3500 3D High Definition Wheel Alignment System

SKU **OSB** **CMBDWA3500** **19,999⁹⁹**

- 3D HD Camera Technology
- Portable Cabinet/Tower Moves Bay-to-Bay
- Adjustable Camera Height
 Follows Alignment Rack
- Complete 4-Wheel Alignment System
- Includes: 24" Monitor, Color Printer, Compact Wheel Targets and User-Friendly Software
- FREE 1-Year Spec Update and Shop Alignment Banner

CEMB USA
 WHEEL SERVICE EQUIPMENT



ALIGNER INCLUDES:
 Manufacturer's Set-Up and Training

WARRANTY: 2 Years Parts, 1 Year Labor



Customer Responsible For Offloading, Liftgate Service Available.

For OSB, Call 901-300-4878

• Free Delivery in 48 Continental United States • Specifications Subject to Change without Notice or Liability • Equipment Lead Times and Shipping May Vary • Customers Responsible for Offloading Equipment Upon Arrival • Leasing Terms Available, Ask Your AutoZone® Commercial Sales Manager.

ALIGNMENT

FOR HELP with Selection, Confirm Availability and Ordering Instructions, Call 901-300-4878

ALIGNMENT

Alignment Lifts

HOFMANN

12,000 Lb. Scissor Alignment Lift
SKU 1350795
HOFR709APKG **28,799⁹⁹**

- Open Front Design Provides Easy Access to Alignment Service and Calibration Areas
- 24" Wide Runways Provide Easy Drive-On for Large Vehicles
- Dual Engaging Twin Interlocking Mechanical Safety Racks with Pneumatic Release
- 95 Second Lifting Time and 45 Second Lowering Time
- 70" Lifting Height



INCLUDES: Rolling Bridge Jacks, Air Line Kit and Turn Plates

WARRANTY:
1 Year Parts and Labor

FORWARDLIFT
BY ROTARY

14,000 Lb. 4 Post Alignment Lift
SKU OSB
FORCRA14 **23,649⁹⁹**

- Max. Rise: 80-3/4"
- Max. Wheelbase: 182-1/2"
- 4 Wheel Alignment from 88" to 157"
- Long Lasting, High Performance Cable and Sheave System



INCLUDES: Rear Slip Plates, (2) 7,000 Lb. Rolling Jacks, Radius Gauges and Internal Air Line

WARRANTY:
1 Year Parts and Labor

15,000 Lb. 4 Post Open Front Alignment Rack Package - Ext. Length
SKU OSB
CHLAR4115XAO **30,799⁹⁹**

CL Challenger Lifts

- Max. Wheelbase: 210"
- Improved 4-Wheel Alignment Wheelbase with Longer Rear Slip Plates
- Removable Lock without Dropping the Column
- Enclosed Column with No Outside Lubrication
- Improved Column and Cross Beam Design
- Increased Drive Through Clearance
- 26" Wide Runways
- 78" Rise Height



WARRANTY:
2 Year Parts, 1 Year Labor

INCLUDES: Air Line Kit, Slip Plates, Turn Plates and Two Rolling Jacks

4 Post Alignment Lift Combo
SKU OSB
BEN14LSXCOMB1 **15,399⁹⁹**

BendPak

- 14,000 Lb. Capacity
- Overall Length: 241"
- Runway Width: 20"



WARRANTY:
1 Year Parts and Labor

INCLUDES: Air Line Kit, Slip Plates, Turn Plates and Two Rolling Jacks

14,000 Lb. Scissor Alignment Lift Package

coats

SKU OSB
AMM8KSC14KITP
45,149⁹⁹

- Max. Service Wheelbase: 198"
- Max. 4 Wheel Alignment Wheelbase: 160"
- Max. 2 Wheel Alignment Wheelbase: 178"
- Ceiling Height Required: 12'
- Overall Length: 260"
- Overall Width: 91-1/2"
- Lifting Height: 74"



INCLUDES: 2 HD Rolling Jacks, 2 SS Turn Plates, 2 Roll Back Bars and 1 Airline Kit

WARRANTY:
1 Year Parts and 6 Months Labor

15,000 Lb. 4 Post Open Front Ext. Alignment Lift Pkg

coats

SKU OSB
AMM8K4P15XKITP
41,049⁹⁹

- Max. 4 Wheel Alignment Wheelbase: 164-1/2"
- Max. 2 Wheel Alignment Wheelbase: 209"
- Ceiling Height Required: 12'
Raised Height: 75"
- Overall Length: 287-1/2"
- Overall Width:
Front 143" to Rear 137-1/2"



INCLUDES: 2 HD Rolling Jacks, 2 SS Turn Plates, 2 Roll Back Bars and 1 Airline Kit

WARRANTY:
1 Year Parts and 6 Months Labor



Customer Responsible For Offloading.

For OSB, Call 901-300-4878

- Free Delivery in 48 Continental United States
- Specifications Subject to Change without Notice or Liability
- Equipment Lead Times and Shipping May Vary
- Customers Responsible for Offloading Equipment Upon Arrival
- Leasing Terms Available, Ask Your AutoZone® Commercial Sales Manager.

Prices subject to change without notice. Prices do not include applicable taxes, vehicles, tires, rims, installation or optional equipment as shown. Please do not return purchases to the store. For information regarding warranty, repair, or any questions or concerns, call 901-300-4878.

AZG0425

89

Alignment Combo

27,399⁹⁹

CK-14KACX-IWA

iDEAL Alignment Lift & Wheel Aligner Combo Bundle Kit

SKU: 429041

- High Performance Commercial Alignment Lift
- Durable, High Quality Cable Lift System
- Extended Rise Height
- 'Bolt-On' Runway Alignment Kit
- 18 Locking Height Positions
- 20" Wide Runways
- Slack Cable Safety Devices
- Self-Checking Approach Ramps W/ Nylon Rollers
- Wide Scope High Resolution 3D Industrial Grade Cameras



Combo Bundle Kit = (1) FP14KAC-X Alignment Lift
(2) RAJ-7K-H Bridge Jacks & (1) IAW-60-2000T-K iPRO Wheel Aligner

Two Post Lifts



5,299⁹⁹

iDEAL - TP10KAC-DX

10,000lbs CAPACITY
SKU 942096

- ALI Certified
- Bi-symmetric Arms
- Overall Height: 144"
- Overall Width: 145-1/2"
- Bi-Symmetric Lift Arms
- Low Profile Swing Arm Design
- 3 Stage Front Arms
- Adjustable Height Swivel Pads
- Stackable Height Adapters



Price Does Not Include Vehicle, Installation or Optional Equipment as Shown

Paint Booths



PSB-AFCF23B-3PH-230V-AK

Cross Flow Paint Booth

SKU 799158

- Inside Dimensions: 22'-6" L X 13' W X 8'-6" H
- 5/16" Bolt & Nut Assembly
- 18 Gauge Panels
- UL Listed Dayton 24" Tube-Axial Fan
- Double Entry Doors w/ Shutoff Switch
- Meets or Exceeds All Applicable OSHA & NFPA 33 Regulations



Storage Lifts

FP8K-DX-XLT

8,000lbs CAPACITY

SKU 426415

- Extended Lift Height & Length
- Cable Driven Lifting System
- Single Point Manual Lock Release
- Slack Cable Safety
- Steel Approach Ramps
- Adjustable Locking Positions

4,869⁹⁹



TP11KC-DX

11,000lbs CAPACITY
SKU 426140

- Direct "Pull" Cylinders
- Overall Height: 145"
- Overall Width: 145-1/2"
- 3 Stage Front Arms,
- Low Profile Arms
- Rubber Door Guards
- Spin Up Pads with stackable drop in Height Adapters

5,099⁹⁹



BI-SYMMETRIC™ DESIGN
Asymmetric/Symmetric arm configuration with 180 degree front arm rotation.

TUXEDO

Scissor Lifts

PSB-SDD26B-3PH-230V-AK

Side Down Paint Booth

SKU 592190

- Inside Dimensions 26' L X 14' W X 9'3" H
- 5/16" Bolt & Nut Assembly
- 18 Gauge Panels
- UL Listed Dayton 24" Tube-Axial Fan
- Personnel Door w/ Shutoff Switch
- Meets or Exceeds All Applicable OSHA & NFPA 33 Regulations



27,699⁹⁹

LR-10K-TLPAD

10,000lbs CAPACITY

SKU 1404546

- Ideal For Express Tire & Wheel Service
- Surface Mount Install Configuration
- Integrated Outer Frame & Ramps Provide Drive-On & Off Clearance For Wide Vehicles
- Latch Release Handles On Each Side Of Lift

4,639⁹⁹



TP9KACX

9,000lbs CAPACITY
SKU 426138

- Asymmetric Arms
- Overall Height: 143"
- Overall Width: 138"
- Spin Up Pads with stackable drop-in height adapters

3,179⁹⁹



TUXEDO

Wheel Service

TC-950

Semi-Automatic Tire Changer

SKU 426755

- Max Wheel Diameter: 47"
- Rim Width: 3" - 15"
- Rim Diameter: 15" - 28"

2,679⁹⁹



Single Post

SC-2K-UTV-X

iDEAL Single Column, UTV & Mower Storage/ Service Lift
SKU 1413367

- 2,000 lbs Capacity
- Multi-Purpose Single Column Dual Platform Lift Design
- Ideal Storage Solution for Most Small to Mid-Sized ATVs, UTVs, Golf Carts, Riding Lawnmowers & Zero Turns

4,939⁹⁹



Price Does Not Include Vehicle, Installation or Optional Equipment as Shown

TP9KFx

9,000lbs CAPACITY
SKU 426106

- Symmetric Arms
- Overall Height: 112"
- Overall Width: 134.5"
- Spin Up Pads with Stackable drop-in height adapters

3,099⁹⁹



TUXEDO

DON'T FORGET THESE ACCESSORIES!



PWB-1600
1,600 lbs Workbench
SKU 1284169

599⁹⁹



SJ-35
Sliding Jack
SKU 426447

1,289⁹⁹



8G DRAIN
8 Gallon Drain
SKU 426733

164⁹⁹

AUTOMOTIVE LIFTS

FOR HELP with Selection, Confirm Availability and Ordering Instructions, Call 901-300-4878

AUTOMOTIVE LIFTS

Challenger Lifts

10,000 Lb. 2 Post Offset Arm Design Lift

SKU **OSB CHLVLE10** **5,799⁹⁹**

Versymmetric[®] 3-Stage Offset Front Arms

- Lifts Asymmetric and Symmetric in the Same Service Bay
- Rubber Door Guards

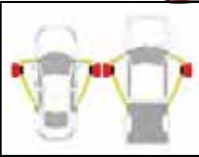

Available in Red and Blue



WARRANTY: 1 Year Parts and Labor

INCLUDES: Telescoping Footpads

10,000 Lb. 2-Post Versymmetric[®] Adjustable Lift

SKU **OSB CHLCL10AV3** **7,399⁹⁹**

3-Stage Front, 3-Stage Rear Arms with Swept Arm Design

- 3 Adjustable Widths and 2 Adjustable Heights
- Can Be Set Up to Lift Most EVs
- Arm Reach: Front - Min. 20", Max. 42" Rear - Min. 37-5/8", Max. 60"
- Ceiling Height Required: 12' Minimum
- Width: 14' Recommended



Versymmetric[®] Technology

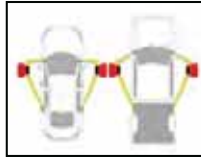

Available in Red, Blue and Black



WARRANTY: 2 Years Parts and 1 Year Labor

INCLUDES: Telescoping Footpads

12,000 Lb. 2 Post Symmetric Lift

SKU **OSB CHLLE12-3S** **10,349⁹⁹**

- Heavy Duty 3-Stage Front and Rear Arms
- Single-Point Mechanical Lock Release
- Adjustable Column Height: 166" or 175"
- Padded Overhead Shut-Off System
- Powder Coat Finish
- Standard Dual Integrated Rubber Door Guards
- Includes: (4) 3" Stack Extensions, (2) 6" Stack Extensions and (2) Organizer Racks with Hardware



Available in Red and Blue

WARRANTY: 1 Year Parts and Labor

12,000 Lb. 2 Post Symmetric Lift

SKU **OSB CHLCL12A** **11,299⁹⁹**

- 3 Stage Front and Rear Arms Provide Extension and Retraction to Lift Everything from Small Sedans to Pickup Trucks
- Adjustable Height: 158" to 164"
- Adjustable Width: 142"/148"/154"
- Includes 10315 Stack Adapter Kit, (4) 3" Stack Adapters, (2) 6" Stack Adapters, (2) Organizer Racks with Hardware



Available in Red, Blue and Black

WARRANTY: 2 Year Parts, 1 Year Labor

12,000 Lb. 2 Post Symmetric Lift

SKU **OSB CHLLE12** **9,699⁹⁹**

WARRANTY: 1 Year Parts and Labor

14,000 Lb. 4 Post Closed Front Lift

SKU **OSB CHL4P14EFX**

- 20" Wide Runways
- Max. Wheelbase: 182.5"
- Minimum Bay Size: 12' x 24'
- Rise Height: 78"
- Color: Black Only



Air Line Kit
SKU **OSB CHL40230E** **609⁹⁹**



WARRANTY: 1 Year Parts and Labor
Rolling Jacks Sold Separately

One 7,500 Lb. Rolling Jack

SKU **OSB CHLRJ75**

3,749⁹⁹



Optional Equipment

WORKS WITH



BEFORE PLACING YOUR AUTOMOTIVE LIFT ORDER:

Please verify minimum ceiling height, concrete requirements and bay size. See page 2 for delivery information or **Call 901-300-4878.**

Quality Lifts



10,000 Lb. 2 Post Lift

SKU **OSB CHLEQ10** **5,249⁹⁹**

- 3-Stage Front, 2-Stage Rear Arms
- Lifts Symmetrically or Asymmetrically
- Ceiling Height Required: 12'
- Rubber Door Guards
- Padded Overhead Shut-Off Bar
- Single-Point Lock Release System
- Color: Black Only



INCLUDES: (4) 3" Stack Adapters

WARRANTY: 6 Months Parts and Labor

UPGRADE YOUR QUALITY LIFT

Double Telescoping Foot Pads (4 Pack)

SKU **OSB CHLB2270PK4** **649⁹⁹**

- 10,000 Lb. Footpads
- Fits Quality 10,000 Lb. 2 Post Lifts
- Single Pad Features Frame Engaging Ears



(2) 6" Stack Adapters

SKU **OSB CHL10313** **209⁹⁹**

- Upgrade for CHLEQ10 Lift



12,000 Lb. 2 Post Heavy Duty Lift Screw-Style Footpad

SKU **OSB CHLB12162S-12** **139⁹⁹**

- Fits Challenger and Quality 12,000 Lb. Heavy Duty 2 Post Lifts
- Single Pad Features Frame Engaging Ears



Customer Responsible For Offloading.

For OSB, Call 901-300-4878

- Free Delivery in 48 Continental United States
- Specifications Subject to Change without Notice or Liability
- Equipment Lead Times and Shipping May Vary
- Customers Responsible for Offloading Equipment Upon Arrival
- Leasing Terms Available, Ask Your AutoZone[®] Commercial Sales Manager.

Prices subject to change without notice. Prices do not include applicable taxes, vehicles, tires, rims, installation or optional equipment as shown. Please do not return purchases to the store. For information regarding warranty, repair, or any questions or concerns, call 901-300-4878.

AZG0425

AUTOMOTIVE LIFTS

Coats Lifts

10,000 Lb. 2 Post Lift with 3 Stage 2n1 Arms

SKU **OSB AMM4TV21NSR1** **8,249⁹⁹**

- 90" Offset 3-Stage Front and Rear Arms for Asymmetric or Symmetric Vehicle Positioning
- Includes Door Bumper Guards and Lifting Adapters
- Premium U.S. Made Power Unit
- Overall Height: 138" or 148"



12,000 Lb. 2 Post Lift with 3 Stage Symmetric Straight Arms

SKU **OSB AMM4T212SSR1** **10,999⁹⁹**

- Includes: Door Bumper Guards and Lifting Adapters
- Overall Width: 137-1/8"
- Overall Height: 154-7/8" or 158-7/8"
- Color: Red



12,000 Lb. 2 Post Lift with 3 Stage 2n1 Arms

SKU **OSB AMM4T212NSR1** **10,999⁹⁹**

WARRANTY: 1 Year Parts, 6 Months Labor

Forward Lifts

10,000 Lb F10 2 Post Lift

SKU **OSB FORF10N500MBK** **6,299⁹⁹**

- Three-Stage Front Arms and Two-Stage Rear Arms
- Includes Drop In Adapters and 4 Extensions
- Overall Height 141"
- Color: Black



INCLUDES:
Truck Adapters

WARRANTY:
1 Year Parts and Labor

112 Symmetrical Two Post Lift 12K Capacity

SKU **OSB FORI12N300BK** **12,699⁹⁹**

- Three-Stage Front and Rear Arms
- Includes Drop-In Adapters With 4 Extensions
- Overall Height 166"
- Color: Black



INCLUDES:
Truck Adapters

WARRANTY:
1 Year Parts and Labor

14,000 Lb. CR14L 4 Post Lift

SKU **OSB FORCR14L** **9,999⁹⁹**

- Heavy Duty Hydraulic Cylinder
- Single Point Latch Release System
- 78-3/4" Rise
- 18 Lock Positions
- Accommodates 182-1/2" Wheelbase Vehicles
- High Performance Cable and Sheave System



Internal Air Line Kit

SKU **OSB ROTFC5760-14** **679⁹⁹**

Rolling Jacks Sold Separately

WARRANTY:
1 Year Parts and Labor

WORKS WITH

One 7,000 Lb. Rolling Jack

SKU **OSB FORRRJ70G**

4,189⁹⁹

Optional Equipment

Two 7,000 Lb. Rolling Jacks

SKU **OSB FORRRJ70GB0G0**

5,959⁹⁹

Optional Equipment

Offer Valid Only with Purchase of Forward 4 Post Lift

Rotary Lifts

10,000 Lb. 2-Post Asymmetric Lift with AV Arms - Blue

SKU **1580893 ROTSPA10AVBL** **9,049⁹⁹**

- Easy Spotting and Positioning
- Highest Capacity Low-Profile Lift Available
- Comes Standard with Adjustable Round, Truck and Stackable Adapter Extensions
- Overall Width: 11' 5-1/2"
- Overall Height: 11' 11-1/2"
- Arm Reach: Front: Min. 18-1/2" - Max. 41", Rear: Min. 27-5/8" - Max. 58-1/4"
- Max Rise: 81-1/2"
- Drive-Thru Clearance: 95-1/4"
- Min. Bay Size: 12' x 24"

WARRANTY: 1 Year Parts and Labor



Shown with Additional Accessories

14,000 Lb. 4 Post Lift

SKU **OSB ROTSM14L** **11,449⁹⁹**

- Filter/Regulator/Lubricator Included to Extend the Life of Lift and Tools
- Max. Wheel Base: 182"
- 78" Rise
- Long Lasting Cables and Sheaves

Rolling Jacks Sold Separately

Internal Air Line Kit

SKU **OSB ROTFC5760-14**

679⁹⁹



WARRANTY:
1 Year Parts and Labor

WORKS WITH

One 7,000 Lb. Rolling Jack

SKU **OSB ROTRJ7100Y**

5,509⁹⁹

Optional Equipment



Customer Responsible For Offloading.

For OSB, Call 901-300-4878

• Free Delivery in 48 Continental United States • Specifications Subject to Change without Notice or Liability • Equipment Lead Times and Shipping May Vary • Customers Responsible for Offloading Equipment Upon Arrival • Leasing Terms Available, Ask Your AutoZone® Commercial Sales Manager.

AUTOMOTIVE LIFTS

FOR HELP with Selection, Confirm Availability and Ordering Instructions, Call 901-300-4878

AUTOMOTIVE LIFTS

BendPak® Lifts

10,000 Lb. 2 Post Lifts

- Bi-Metric™ Reversible Triple Telescoping Swing Arms
- Low-Pro™ Swing Arms
- Automatic Arm Restraints
- Expandable Top Beam Accommodates Wide or Narrow Drive-Thru Configurations

SKU **OSB** BEN10AP
6,374⁹⁹

- Height: 145"
- Width: 135" to 145"
- Rise: 69"



BEN10AP

SKU **OSB** BEN10APX
6,649⁹⁹

- Height: 157"
- Width: 135" to 145"
- Rise: 75.5"

WARRANTY: 1 Year Parts and Labor

SKU **OSB** BEN10AP-168
6,924⁹⁹

- Height: 168"
- Width: 135" to 145"
- Rise: 69"

- 24" Bolt-On Extension for Increased Vehicle Height Clearance

SKU **OSB** BEN10AP-181
7,199⁹⁹

- Height: 181"
- Width: 135" to 145"
- Rise: 75.5"

- 24" Bolt-On Extension for Increased Vehicle Height Clearance

BendPak®

12,000 Lb. 2-Post BiMetric Lift

SKU **OSB** BEN12APX
11,899⁹⁹

- Adaptable Design: Symmetric or Asymmetric
- Automatic Swing Arm Restraint System
- Includes: 4 Frame Cradle Pads, 4 Medium and 4 Tall Stacking Adapters



12,000 Lb. 2-Post Short-Rise Floorplate Lift

SKU **OSB** BEN12AP-SRT
8,249⁹⁹

- Post Height: 93.5"
- Max. Lifting Height: 46"

Great Choice for Low Ceiling Height Where You Do Not Need To Work Underneath the Vehicle



INCLUDES: 4 Frame Cradle Pads, 4 Medium and 4 Tall Stacking Adapters



WARRANTY: 1 Year Parts and Labor

16,000 Lb. 2-Post Lift

SKU **OSB** BEN16AP
20,899⁹⁹

- Telescoping Arms Accommodate a Wide Variety of Vehicle Chassis
- Dual Direct-Drive Hydraulic Cylinders for Smoother Operation and Less Maintenance
- Includes: 4 Frame Cradle Pads, 4 Medium and 4 Tall Stacking Adapters with Column-Mounted Racks



WARRANTY: 1 Year Parts and Labor

INCLUDES: 4 Frame Cradle Pads, 4 Medium and 4 Tall Stacking Adapters



10,000 Lb. Low-Rise Lift

SKU **OSB** BENLR-10000
5,299⁹⁹

- Min. Height: 4.5"
- Max. Lift Height: 23"
- Lift Height + Blocks: 32"



WARRANTY: 1 Year Parts and Labor

7,000 Lb. Full-Rise Scissor Lift

SKU **OSB** BENSP-7XE
11,699⁹⁹

- Full-Rise Scissor Design Provides Clear Access
- Open-Center Platform Ideal For Exhaust, Transmission, And Brake Work
- Ultra-Low Profile For Easy Drive-On and Drive-Off
- 68" Rise Height, 84" Overall Length, 78.5" Overall Width, 63" Platform Length, 21" Platform Width, 220V, 1-Phase Power



WARRANTY: 1 Year Parts and Labor

6,000 Lb. Low-Rise Pad Lift

SKU **OSB** BENLR-60
2,999⁹⁹

- Min. Height: 3.5"
- Max. Lifting Height: 23"
- Max. Lift Height + 1.5" Blocks: 24.5"



WARRANTY: 1 Year Parts and Labor

Portable

SKU **OSB** BENLR-60P
3,099⁹⁹

- Min. Height: 4"
- Max. Lifting Height: 23"



Customer Responsible For Offloading.

For OSB, Call 901-300-4878

- Free Delivery in 48 Continental United States
- Specifications Subject to Change without Notice or Liability
- Equipment Lead Times and Shipping May Vary
- Customers Responsible for Offloading Equipment Upon Arrival
- Leasing Terms Available, Ask Your AutoZone® Commercial Sales Manager.

Prices subject to change without notice. Prices do not include applicable taxes, vehicles, tires, rims, installation or optional equipment as shown. Please do not return purchases to the store. For information regarding warranty, repair, or any questions or concerns, call 901-300-4878.

AZG0425

AUTOMOTIVE LIFTS

BendPak® Lifts

14,000 Lb. 4 Post Lift

SKU **OSB**
BENHDS14

8,299⁹⁹

- Overall Width: 130"
- Overall Length: 241"
- Max. Rise: 70"
- Motor: 220 VAC/1 Ph



Shown with Optional Equipment
Rolling Jacks Sold Separately
WARRANTY: 1 Year Parts and Labor

Air Line Kit

SKU **OSB**
BEN5174009

149⁹⁹

WORKS WITH

One 7,000 Lb. Capacity
Rolling Bridge Jack

SKU **OSB**
BENRJ7W **2,349⁹⁹**



Optional
Equipment

9,000 Lb. 4 Post Lift

SKU **OSB**
BENHD-9

5,699⁹⁹

- Overall Width: 110.25"
- Overall Length: 174"
- Column Height: 88" (2,235 mm)
- Max. Lifting Height: 74-1/2" (1,892 mm)



Air Line Kit

SKU **OSB**
BEN5174009

149⁹⁹

WORKS WITH

One 4,500 Lb. Capacity
Rolling Bridge Jack

SKU **OSB**
BENRJ45W **2,449⁹⁹**



Optional
Equipment

Atlas Equipment

For Pricing, Call Your Commercial Sales Manager



Commercial Grade Overhead 2-Post
Lift 15,000 lb. Capacity

SKU **OSB** *Call For Price*
ATLXH-PV15PX-FPD

- Extra Tall and Extra Wide
- Adjustable Height: 165" (13' 9") or 177" (14' 9")
- Special Low Height: 150" (12' 6") (Requires Purchase of Extra Cables)
- Symmetric Arms



WARRANTY: 2 Years Parts Only

Heavy Duty Truck Wheel Balancer

SKU **OSB** *Call For Price*
ATLATWBT-210-FPD

- Computer Controlled Heavy Duty Spin Balancer
- Plastic Quick Release Nut and Heavy Duty Steel Wing Nut Included
- Pneumatic Wheel Lift (External Air Supply Required - Not Included)
- Automatic Start/Stop When Hood is Lowered/Raised
- Static and Dynamic Balancing Modes
- Includes: Cone Sets for Car and Light Truck Tires
- Includes: Cone and Spacer Set for Truck, Bus, or Implement Tires



WARRANTY: 1 Year Parts Only

14,000 Lb. 4-Post Lift

SKU **OSB** *Call For Price*
ATLAP-PVL14-FPD

- Lifting Height: 76-1/2"
- Clearance Under Runways: 69-1/2"
- Width of Columns (with Motor): 140-1/2"
- Length with Approach Ramp: 251-1/2"
- Runway Width: 20"
- Rolling Jacks Sold Separately



WARRANTY: 2 Years Parts Only

12,000 Lb. Heavy Duty 2-Post Lift

SKU **OSB** *Call For Price*
ATLXH-PV12PXF-FPD

- Adjustable Height: 165" (13' 9") or 177" (14' 9")
- Special Low Height: 150" (12' 6") (Requires Purchase of Extra Cables)
- Symmetric Arms
- Automatic Arm Restraints

WARRANTY: 2 Years Parts Only

12,000 Lb. 2 Post Lift

SKU **OSB** *Call For Price*
ATLAP-PVL12-FPD

- Low Pad Height Allows Lift to Accommodate Both Long Wheelbase Trucks and Passenger Cars
- Extra Tall and Extra Wide
- 3-Stage Symmetric Arms
- 8 Piece Truck Adapter Set

WARRANTY: 2 Years Parts Only



NEW



Customer Responsible For Offloading.

For OSB, Call 901-300-4878

- Free Delivery in 48 Continental United States
- Specifications Subject to Change without Notice or Liability
- Equipment Lead Times and Shipping May Vary
- Customers Responsible for Offloading Equipment Upon Arrival
- Leasing Terms Available, Ask Your AutoZone® Commercial Sales Manager.

AUTOMOTIVE LIFTS

FOR HELP with Selection, Confirm Availability and Ordering Instructions, Call 901-300-4878

AUTOMOTIVE LIFTS

Mid-Rise Lifts

BendPak

6,000 Lb. Portable Mid-Rise Lift

SKU **210386** **3,399⁹⁹**
BENMD-6XP

- Portable, Easy to Move from Bay to Bay
- Adjustable Arms



INCLUDES:
 Truck Adapters

WARRANTY:
 1 Year Parts and Labor

CL Challenger Lifts

6,000 Lb. Mid-Rise Portable Lift

SKU **1580897** **4,099⁹⁹**
CHLMR6

- 6 Safety Lock Positions
- Short and Tall Auxiliary Adapters Come Standard
- Sliding/Rotating Arm Design Reaches Pick-Up Points on a Wider Range of Vehicles
- Zerk Fittings on Pivot Points for Serviceability



WARRANTY:
 1 Year Parts and Labor

CL Challenger Lifts

10,000 Lb. Short Rise Lift

SKU **OSB** **6,299⁹⁹**
CHLSRM10

- Min. Height: 4.25"
- Max. Height: 22"
- Includes: (4) 2 Position Adapter Blocks
- Three Locking Positions for Ease of Use
- Color: Black Only

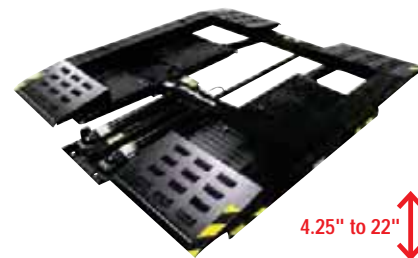

WARRANTY:
 1 Year Parts and Labor

MaxJax Lift

MAXJAX

MaxJax M7K

SKU **1360718** **4,699⁹⁹**
MJXM7K

- Min. Pad Height: 5.5"
- Height Overall: 89.5"
- Max. Lift Height: (Pad Only) 47.25" (With 3" Adapter) 50.5"
- Clear Undercar Access
- Portability
- Stow to Go in Less Than 15 Minutes



WARRANTY: 1 Year Parts and Labor

QuickJack™ Lifts

QUICKJACK

You get it all.

- Complete Package Includes: 2 Jack Frame Assemblies, (2) 150" Hydraulic Hoses, (2) 14" Aux. Hoses, 2 Quick-Mount Handles, (4) 1.5" x 3" x 4" Rubber Lifting Blocks, (4) 3" x 3" x 4" Rubber Lifting Blocks, 1 Mini Hydraulic Power Unit with Pendant Control



8000TLX Extended-Length Portable Truck and SUV Lift

SKU **OSB** **2,299⁹⁹**
QJK8000TLX

- Capacity: 8,000 Lb.
- 66" Lift Point Reach
- Fast and Easy Setup
- Stackable Rubber Blocks
- Automatic Safety Locks
- Increased Lifting Height
- Undercarriage Access
- One Handed Operation



QuickJack™ SUV and Light Truck Adapters

SKU **862288** **249⁹⁹**
RAN5150561

- Fits BL-5000 and BL-7000 Series
- Set of 12 Pieces Includes: 4 Low Profile Round Polyurethane Contact Pads, 4 Sliding Receivers That Accommodate the Round Polyurethane Contact Pads and (4) 3" Stackable Adapters



Motorcycle Lift

OEM TOOLS

Air Hydraulic Motorcycle Lift 1,000 Lb. Capacity

SKU **662742** **1,299⁹⁹**
24859

- Our Lift Compares to Top Brand Motorcycle Lifts in Every Way**
- 86.5" x 26.75" Platform Deck with 25.5" Long Removable Loading Ramp
 - Built-In Casters and Adjustable Stabilizers
 - Durable 12 Gauge, Powder Coated Diamond Plate Deck
 - Air/Hydraulic Lift System Allows Use with Shop Air or as a Manual Lift
 - Tie Down Rings on Deck for Added Stability



Heavy Duty, Positive Stop, Padded Wheel Vise



Rear Dropout Panel (for Rear Tire Maintenance Access)



Customer Responsible For Offloading.

For OSB, Call 901-300-4878

- Free Delivery in 48 Continental United States
- Specifications Subject to Change without Notice or Liability
- Equipment Lead Times and Shipping May Vary
- Customers Responsible for Offloading Equipment Upon Arrival
- Leasing Terms Available, Ask Your AutoZone® Commercial Sales Manager.

Prices subject to change without notice. Prices do not include applicable taxes, vehicles, tires, rims, installation or optional equipment as shown. Please do not return purchases to the store. For information regarding warranty, repair, or any questions or concerns, call 901-300-4878.

AZG0425

AUTOMOTIVE LIFTS

Lift Pads



Forward/Eagle/Gemini/
Worth/American Hexagon
Shaped - 2 Bolt Style Lift Pads
(Set of 4)
SKU 1137807 **89⁹⁹**
SHA51663



Fits Models

I-DP9, DP09A2,
DP09A, DP07A,
DP97A, DP7A,
Eagle and Other
Texas Style
2 Post Lifts

Replaces

OEM#
994105,
991234,
991222 and
LP603

Hexagon Shaped - 2 Bolt Style
Lift Pads (Set of 4)
SKU 1137812 **119⁹⁹**
SHA51661



20000, 21000,
26000, 27000,
28000, 30000,
31000, 33000,
36000, 37000,
39000

OEM#
JOK01D,
LP602

Challenger Rubber Round Slip-On
Lift Pad
SKU OSB
CHLB2208 **29⁹⁹**



For OSB, Call
901-300-4878

Challenger CL10, E10,
Q10, VS10 and
Ammco AC21NS

N/A

Quality Round Slip-On Lift Pads
SKU 1137816 **54⁹⁹**
SHA51673



VS10, CI10, E10,
TLT210, TLT210-AS,
TLT211, TLT211-AS,
ACD210S and More

OEM#
104130315,
B2208

Rotary Square Bolt Style
Lift Pads (Set of 4)
SKU 1137817 **129⁹⁹**
SHA51667



SPO9, SPOA9,
SPO10, SPOA10,
SPO12, SI29,
SL19, SL210

OEM#
FJ6213,
BH-7536-92P,
BH7542-73
and LP609

BendPak Square Slip-On
Lift Pads (Set of 4)
SKU 1137805 **134⁹⁹**
SHA51666

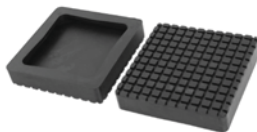

MX10AC, MXACX,
X10CX, MX10C,
XPR-9S, XPR-9S-LP,
XPR-9DS, XPR-10S,
XPR-10S-LP,
XPR-10S-168,
XPR-10AS,
XPR-10AS-LP,
XPR-10AS-168,
XPR-12FDL,
XPR-12CL, XPR-15CL,
XPR-18CL,
XPR-12CL-192,
XPR-15CL-192,
XPR-18CL-192, RJ6,
RJ6000, RJ4500

OEM#
5715-365
and LP608

Challenger



Electric Vehicle Footpad - Set of 4
SKU 1544676 **909⁹⁹**
CHLEVPFK

- Designed Specifically to Work on Electric Vehicles
- Fits All 10K and 12K 2-Post and Inground Lifts
- Double-Screw-Up for Finer Adjustments
- Low Profile, Fits in Small Places
- Durable, Thin Pad



Truck Adapter Set for 10,000 Lb.
and 12,000 Lb. 2 Post Lifts
SKU OSB
CHL10315 **499⁹⁹**

- Stack Adapter Extension Kit Includes:
(4) 3" Stack Extensions,
(2) 6" Stack Extensions and
2 Organizer Racks with Hardware



GM Wide Frame Footpads (Pair)
SKU OSB
CHLB2280PR **689⁹⁹**

- Fits 2008 and Up Challenger Lifts CL10V3, E10, LE10,
VLE10, SA10, CLFP9, E12, CL12 and EV1020 Models
- Works on 2019 GMC Sierra and Chevrolet
Silverado Half-Ton Trucks
- Drop-In Design Makes Switching Simple and Quick
- Telescoping Feature Provides Simple
Access to Lift Points



For OSB, Call 901-300-4878

BendPak



Rubber 2 Post
Lift Pad/Slip Over
(Set of 4)
SKU 954179 **99⁹⁹**
BEN5700227

- Heat and Cold Resistant
- Highly Resistant to Gouging
- Oil and Solvent Resistant
- Tear Resistant



Lift Pad Assembly/
35 mm Pin (Set of 4)
SKU 1053947 **199⁹⁹**
BEN5215753

- Works with Any BendPak 2 Post Lift
- Thick Rubber Construction
- Textured Surface for Extra Grab
- Will Not Scratch the Vehicle
- Easy Drop-In Design
- 5" Diameter for
Enhanced
Stability



Cradle Pads

- Tactile Rubber Pad Reduces Slippage and Protects the Finish
- Made for Heavy Duty Commercial-Grade Trucks
- Installs Easily to BendPak 2 Post Lift Arms
- Sturdy Steel Construction

Frame Cradle Pads
35 mm Pin (Set of 4)
SKU 954221 **249⁹⁹**
BEN5215754



Wide Frame Cradle Pads
60 mm (Set of 2)
SKU 979067
BEN5215848 **249⁹⁹**



Prices subject to change without notice. Prices do not include applicable taxes, vehicles, tires, rims, installation or optional equipment as shown. Please do not return purchases to the store. For information regarding warranty, repair, or any questions or concerns, call 901-300-4878.

BendPak®

2-POST LIFTS



16AP 16K lb. Capacity Clearfloor Super-Duty 2-Post Lift

SKU OSB BEN16AP

~~\$22,095~~ **\$20,899⁹⁹**

- Max. Rise - 76"
- Height - 169" / Width - 168"



20AP 20K lb. Capacity Clearfloor Super-Duty 2-Post Lift

SKU OSB BEN20AP

~~\$25,195~~ **\$23,699⁹⁹**

- Max. Rise - 76.5"
- Height - 169" / Width - 168"

INCLUDES



TIRE SHOP ESSENTIALS

~~\$8,695~~ **\$8,249⁹⁹**



12AP-SRT 12K Capacity Mid-Rise Two-Post Lift

SKU OSB BEN12AP-SRT

- Max. Rise - 42.75"
- Overall Height - 93.5"
- Overall Width - 155"

4-POST LIFTS

HDS-14XT EXTENDED Length Tall Four-Post Lift

SKU OSB BENHDS14XT

~~\$9,795~~
\$9,349⁹⁹

- Capacity - 14,000 lbs.
- Max. Rise - 82.75"
- Width - 131.25"
- Length - 272"



RJ7W \$2,349⁹⁹
7,000 lb. Capacity Rolling Bridge Jack
SKU OSB BENRJ7W

HEAVY-DUTY

HDS-27X EXTENDED Length Four-Post Lift

SKU OSB BENHDS27X

~~\$27,195~~ **\$25,874⁹⁹**

- Capacity - 27,000 lbs.
- Width - 153.5"
- Length - 372.75"



HDS-40X EXTENDED Length Four-Post Lift

SKU OSB BENHDS40X

~~\$38,095~~
\$36,399⁹⁹

- Capacity - 40,000 lbs.
- Width - 153.5"
- Length - 373.75"

Ranger®

BY BENDPAK

HEAVY-DUTY

RB30T Car & Truck Wheel Balancer

SKU OSB RAN30T

- Max. Tire Diam. - 48"
- Max. Tire Weight - 330 lbs.
- LED Wheel Weight Display

~~\$14,095~~ **\$13,499⁹⁹**

R26FLT Super-Duty Truck Tire Changer

220V - SKU OSB RAN26FLT

~~\$12,595~~
\$12,049⁹⁹



- Maximum Tire Diameter - 63"
- Maximum Rim Diameter - 14" - 26"
- Drive System - Electric / Hydraulic



SPRAY WASHERS



RS-750D Spray Wash Cabinet

SKU OSB RANRS750D

- 1,000 lb. Load Capacity
- 53 gal. Tank Capacity
- Interior Dimensions 54" x 32"

~~\$9,195~~
\$8,799⁹⁹

RS-750DS STAINLESS STEEL Spray Wash Cabinet

SKU OSB RANRS750DS

- 1,000 lb. Load Capacity
- 53 gal. Tank Capacity
- Interior Dimensions 54" x 32"

~~\$13,795~~
\$13,199⁹⁹

FREE 20-lb. Soap Bucket w/ all spray wash cabinets

PACKAGE DEAL

R80EX 220V Tire Changer
LS45DS 220V Wheel Balancer
Tape Weight Rolls / Blk. & Slv. 1400 pc.
PACKAGE SKU OSB RANCOMB018

~~\$16,595~~
\$15,874⁹⁹



Ask about our setup and training options

TIRE SERVICE

Coats Combos

RC-45E and 885 Tire Service Combo

SKU **OSB**
AMMCOMB05

10,899⁹⁹ **SAVE* \$349**

- External Rim Clamping Range from 6" to 24" (Max. Tire Diameter 50"; Max. Rim Width 10.5")
- Tire Changer Allows Inflation from 0 to 60 psi with a Built-In Pressure Limiter
- RC-45E Drive System: 1 HP Electric Motor
- 885 Balancer - Automatic Distance and Diameter Entry
- Direct Tape-A-Weight® Placement
- Auto Start Hood
- 110V



AMM800885

AMM8560994901

INCLUDES:
Setup and Training

WARRANTY: 1 Years Parts and 6 Months Labor

* Savings based on the price of items if purchased separately.

RC-55E and 1300 Series Tire Service Combo

SKU **OSB**
AMMCOMB02

14,849⁹⁹ **SAVE* \$449**

- RC-55E Features an External Clamping Range from 6" to 24" (Max. Tire Diameter 50"; Max. Rim Width 10-1/2")
- RC-55E Drive System: 1 HP Electric Motor
- Tire Changer Allows Inflation from 0 to 60 psi with a Built-In Pressure Limiter
- 1300 Series Wheel Balancer is Powered by Direct Drive
- Static-On-Screen® Display Identifies Any Excess Residual Static Imbalance
- Wheel Balancer Automatically Enters 2-D Data for Wheel Diameter and Offset Measurement



AMM80013002D

COATS

AMM8560995001

INCLUDES: Setup and Training

AMM8560995001 - WARRANTY: 1 Year Parts and 6 Months Labor

AMM80013002D - WARRANTY: 3 Years Parts and 6 Months Labor

* Savings based on the price of items if purchased separately.

DON'T FORGET THESE ACCESSORIES

- Works with Coats Wheel Balancers Listed on This Page



Adjustable Pin Plate Set **1,599⁹⁹**

SKU **OSB** | **AMM820000400**



40 mm Light Truck Cone **419⁹⁹**

SKU **OSB** | **AMM8113277C**

Customize Your Own Combo, Call for Special Pricing **901-300-4878**

Rotary Combos

R146P and R155 Tire Service Combo

SKU **OSB**
ROTCOMB04

15,249⁹⁹ **SAVE* \$799**

- Includes: R146P Tire Changer and R155 Balancer High Quality Swing Arm Changer and Pro 3D Wheel Balancer at an Economical Price
- Changer Offers 26" Outside and 28.5" Inside Clamping with Tire Diameters Up to 46"
- PLUS91SA Helper Arm Not Installed Prior to Delivery
- Balancer Features Automatic Program, Linked Keyboard, Internal Data Gauge, and Simple Visual Display
- This Combo is Ideal for High-Volume Tire Shops and General Repair Bays

R146P

- Inside Clamping: 12 to 28.5"
- Outside Clamping: 10 to 26"
- 115V, Single Phase

R155

- Rim Diameter: 10" to 30"
- Rim Width: 1.5" to 22"
- 115V, Single Phase
- 8 Piece Collet Kit Included



ROTR155

ROTR146P

INCLUDES: Setup and Training

* Savings based on the price of items if purchased separately.

WARRANTY: 3 Years Parts and 1 Year Labor

R146P and R148 Tire Service Combo

SKU **OSB**
ROTCOMB05

13,899⁹⁹

Rotary

- R146RP Tire Changer with Swing-Arm Design, Helper Arm and Hand Bead Breaker; Handles Wheels up to 26" Outside and 39" Overall Diameter
- Built-In Air Tank and Plastic Mount/Demount Head
- R148 Pro 2D Wheel Balancer Features Auto Distance and Diameter Entry, LED Display, and Split/Hidden Weight Modes
- Includes: 8 Piece Double Sided Collet Kit
- Rim Diameter: 10" to 30"
- Rim Width: 1.5" to 20"

SAVE* \$179



ROTR148

ROTR146P

INCLUDES: Setup and Training

* Savings based on the price of items if purchased separately.

WARRANTY: 3 Years Parts and 1 Year Labor



Customer Responsible For Offloading, Liftgate Service Available.

For OSB, Call 901-300-4878

- Free Delivery in 48 Continental United States
- Specifications Subject to Change without Notice or Liability
- Equipment Lead Times and Shipping May Vary
- Customers Responsible for Offloading Equipment Upon Arrival
- Leasing Terms Available, Ask Your AutoZone® Commercial Sales Manager.

TIRE SERVICE

FOR HELP with Selection, Confirm Availability and Ordering Instructions, Call 901-300-4878

TIRE SERVICE

CEMB Combos

EZ10 and SM825EVOPA Swing Arm Tire Changer Combo
SKU OSB
CMBCOMB03 **10,999⁹⁹**

SAVE*
\$799

- Tire Changer Clamping Range of 13" to 24"
- Max. Tire Diameter 44" and Max. Tire Width 15"
- Powerful and Adjustable Bead Breaker Shovel
- Dual Clamping Cylinders and Semi-Automatic Swing Arm
- 3D Wheel Measurement with Sonar
- Automatic Approach and Auto Adaptive Mode to Save Balancing Time
- Electromagnetic Brake
- 3D Inner Data Entry Arm Eliminates Rim Width Caliper Use
- Direct Measures Input Feature Eliminates Selection of Balancing Modes
- Guided Weight Placement, ALU, Hidden Spoke Modes



CMBE10

CMBSM825EVOPA

ER72D Balancer and SM628BPS Tire Changer Combo
SKU OSB
CMBCOMB04 **17,749⁹⁹**

SAVE*
\$1,399

- Includes ER72D Balancer and SM628BPS Tire Changer
- Tire Changer: Clamps Up to 16" Rims, Handles Tires Up to 44" Diameter
- Ideal for 19.5" Tires
- Balancer: Laser Weight Spotter and 3D Data Arm Entry
- Guided Weight Placement and Quick-Clamp Wing Nut



CMBER72D

CMBSM628BPS

* Savings based on the price of items if purchased separately.

* Savings based on the price of items if purchased separately.

On-Site Training Included WARRANTY: 2 Years Parts and 1 Year Labor

Ranger Combos

R76ATR and DST30P
Tire Service Combo
SKU OSB
RANCOMB03 **10,699⁹⁹**

SAVE*
\$389

- Inflation Pressure Regulator/Limiter
- Bead Tool/Tire Iron Automatic Braking
- Black and Silver Powder-Coated Surface Helps Eliminate Corrosion and Staining of Expensive Wheels
- Low Profile Design for Increased Clearance of Close-Proximity Calipers or Brake Components



RANR76ATR

RANDST30P

R980XR and DST-2420
Tire Service Combo
SKU OSB
RANCOMB01 **7,499⁹⁹**

SAVE*
\$409

- Includes: R980XR NEXTGEN™ Swing-Arm 30" Tire Changer and the DST-2420 Dynamic Wheel Balancer
- R980XR External Rim Clamping Capacity: 9" to 28", Internal Clamping 10" to 30"
- 3-Position RimGuard™ Wheel Clamps
- DST-2420 Dynamic Wheel Balancer Dependably Ensures an Accurate Result within Hundredths of an Ounce



RANDST2420

RANR980XR

* Savings based on the price of items if purchased separately.

* Savings based on the price of items if purchased separately.

R76ATR and LS45DS
Tire Service Combo
SKU OSB
RANCOMB014 **13,199⁹⁹**

SAVE*
\$359

- Includes: R76ATR Tire Changer and LS45DS Wheel Balancer
- R76ATR Tilt-Tower Tire Changer
- Handles External Rim Clamping from 9" to 28"
- Equipped with a Durable Electric Turntable with Reversible Direction
- LS45DS Sonar 3D Wheel Balancer
- Features Automatic 3D Data Entry for Faster, More Accurate Balancing
- Supports Wheel Sizes from 12" to 24"
- Accommodates Tires Up to 31.5" in Diameter



RANR76ATR

RANLS45DS

* Savings based on the price of items if purchased separately.

User Setup Required WARRANTY: 1 Year Parts and Labor



Customer Responsible For Offloading, Liftgate Service Available.

For OSB, Call 901-300-4878

- Free Delivery in 48 Continental United States
- Specifications Subject to Change without Notice or Liability
- Equipment Lead Times and Shipping May Vary
- Customers Responsible for Offloading Equipment Upon Arrival
- Leasing Terms Available, Ask Your AutoZone® Commercial Sales Manager.

Prices subject to change without notice. Prices do not include applicable taxes, vehicles, tires, rims, installation or optional equipment as shown. Please do not return purchases to the store. For information regarding warranty, repair, or any questions or concerns, call 901-300-4878.

AZG0425

99

TIRE SERVICE

Coats Tire Changers

Maxx 50 Tire Changer, 110V
SKU 1350784
AMM800MAXX50E **7,449⁹⁹**

- Dual Nozzle, Hi-Flow Bead Sealing System for Quick, Easy Bead Sealing
- 110V Electric Operation, Plug In Almost Anywhere
- 6" to 24" Steel Clamps Standard
- Nylon Duckhead Standard
- Expanded Capacity to 16" Wheel Width, and Up to 50" Total Diameter



Maxx 50
Tire Changer, Air
SKU OSB
AMM800MAXX50A **7,449⁹⁹**

Maxx 70 Tire Changer, 110V
SKU OSB
AMM800MAXX70 **9,749⁹⁹**

- Dual Nozzle, Hi-Flow Bead Sealing System for Quick, Easy Bead Sealing
- 110V Electric Operation, Plug in Almost Anywhere
- Expanded Capacity to 16" Wheel Width and Up to 50" Total Diameter
- 6" to 24" Steel Clamps Standard
- Steel and Nylon Duckheads Standard
- No-Index Tabletop for High Efficiency Use



Maxx 70
Tire Changer, Air
SKU OSB
AMM800MAXX70A
9,749⁹⁹

Maxx 70 Tire Changer, 220V, 2 HP
SKU OSB
AMM800MAXX70220 **9,749⁹⁹**

Maxx 80 Tire Changer, 110V
SKU 1354781
AMM800MAXX80 **11,249⁹⁹**

- Dual Nozzle, Hi-Flow Bead Sealing System for Quick, Easy Bead Sealing
- Dual Control, Hand or Foot Operated Bead Loosener System
- 110V Electric Operation, Plug in Almost Anywhere
- 6" to 24" Steel Clamps and Zinc Plated 6" to 24" Grip Max. 2.0 Clamps with Dual Soft Compound Inserts
- Expanded Capacity to 16" Wheel Width and Up to 50" Total Diameter
- Steel and Nylon Duckheads Standard
- No-Index Tabletop for High Efficiency Use
- Includes Storage Cabinet



Maxx 80
Tire Changer, Air
SKU 1354782
AMM800MAXX80A
11,249⁹⁹

Tire Changer,
220V, 2 Speed
SKU OSB
AMM800MX802SP **11,799⁹⁹**

Maxx 80 Tire Changer, 220V, 2 HP
SKU 1350785
AMM800MX80220 **11,249⁹⁹**

INCLUDES: Setup and Training

WARRANTY: 3 Years Parts and 6 Months Labor

Coats Wheel Balancers

1185 Wheel Balancer 110V
SKU 1350791
AMM8001185 **6,349⁹⁹**

- Color LCD Video Display
- Max. Tire Diameter: 38"
- Bottom Dead Center Laser
- Position Indexing
- Small Chassis, 110V



WARRANTY:
1 Year Parts
6 Months Labor

1500A 3D Wheel Balancer
SKU 339012
AMM80015003D **10,249⁹⁹**

- Powered by Direct Drive
- Max. Tire Diameter: 44"
- Behind-the-Spoke Mode
- Premium Quicknut
- 8 Piece Collet Kit
- Automatic 3-D Data Entry
- 220V, 1 Phase



WARRANTY:
3 Year Parts
6 Months Labor

1600A 3D Wheel Balancer
SKU 82860
AMM80016003D **11,249⁹⁹**

- Powered by Direct Drive
- Max. Tire Diameter: 44"
- Premium Quicknut
- Behind-the-Spoke Balancing
- 8 Piece Collet Kit
- Automatic 3-D Data Entry
- Touch-Screen
- 220V, 1 Phase



WARRANTY:
3 Year Parts
6 Months Labor

INCLUDES: Setup and Training



Customer Responsible For Offloading, Liftgate Service Available.

For OSB, Call 901-300-4878

- Free Delivery in 48 Continental United States
- Specifications Subject to Change without Notice or Liability
- Equipment Lead Times and Shipping May Vary
- Customers Responsible for Offloading Equipment Upon Arrival
- Leasing Terms Available, Ask Your AutoZone® Commercial Sales Manager.

CEMB

Automatic Wheel Balancer with Monitor
SKU **OSB**
CMBER65

6,999⁹⁹

- Auto-Data Entry of Distance, Diameter and Width
- Laser Pointer for Weight Placement
- 17" Monitor with Intuitive Software
- Auto-Approach Positions Wheel at Correction Point



On-Site Training Included
WARRANTY: 2 Years Parts and 1 Year Labor



3D Data Entry Wheel Balancer
SKU **OSB**
CMBEZ15

5,999⁹⁹

- Electro-Magnetic Brake Holds Weight Position
- Quick-Clamp Wing Nut Auto Adaptive Enhancement with Static Residual Force Minimization
- 3D Inner Data Entry Arm Eliminates Rim Width Caliper Use
- Guided Weight Placement, ALU, Hidden Spoke Mode



On-Site Training Included

WARRANTY: 5 Years Motor, 2 Years Parts, and 1 Year Labor

Ranger

DST-2420 Tire Balancer

SKU **OSB**
RANDST2420

3,049⁹⁹

- Motor: 1.5 HP, 110V/220V, 50/60 Hz, 1Ph
- Balancing Modes: Dynamic/Static/3-Alloy
- Quick-Release Hub Nut for Dramatically Reduced Set-Up Times
- Max. Tire Diameter: 47"
- Balancing Speed: 180 RPM
- Balance Increments: 0.25 or 0.01 Oz.



R980XR NextGen™



Swing-Arm Tire Changer
SKU **OSB**
RANR980XR

4,699⁹⁹

- Motor: 3 HP/220V
- Drive System Type: Electric/Air
- Adjustable RimGuard™ Wheel Clamps
- External Rim Clamping Capacity: 9" to 28"
- Internal Rim Clamping Capacity: 10" to 30"
- Max. Tire Diameter: 50" (1,270 mm)
- Bead Seating System: Turbo Blast/Bead Seating



R80EX Tire Changer

SKU **OSB**
RANR80EX

10,899⁹⁹

- Ranger's Adjustable RimGuard™ Wheel Clamps Feature Internal and External Multi-Teeth Jaws
- Variable Clamp Positioning Makes Wheel Service Simple, Perfectly Controlling the Wheels When Clamping Them
- Geometric Tabletop Provides Easier Bead Lubrication Features a Multi-Axis and Adjustable Bead Loosener Shovel Blade Oversized Axle Minimizes Blade Flex and Improves Durability
- Motor: 3 HP (220 VAC 50-60 HZ)



User Set-Up Required

WARRANTY: 1 Year Parts and Labor

40 mm Truck Cone Kit
SKU **OSB** | **RAN5150032**

499⁹⁹

Works with Ranger Wheel Balancers Listed on This Page



Hofmann

Monty® 3550EM Tire Changer with smartSpeed™

SKU **OSB**
HOFEEWH747B

12,699⁹⁹

- smartSpeed™ Technology Automatically Controls Turntable Speed and Torque to Minimize Tire and Wheel Damage
- Push-Button Controlled Mount/Demount Head Pneumatically Lowers and Locks into Position, Automatically Indexing Away from the Wheel to Prevent Contact and Damage
- Fast and Ergonomic Pneumatic Vertical Arm Automatically Re-Positions the Mounting Head to Minimize Wheel Damage
- High Capacity Tire Changer Allows for Broadest Tire and Wheel Assembly Coverage
- Clamping Range: Inside 12" to 28"; Outside 12" to 26"
- Max. Tire Diameter: 47"
- Max. Tire Width: 17"

INCLUDES: Setup and Training

WARRANTY: 1 Year Parts and 6 Months Labor



Geodyna® 7600P with Laser and Power Clamp

SKU **OSB**
HOFEEWB765AP

9,349⁹⁹

- Power Clamp Clamps Wheel Accurately with Constant Force
- Smart Sonar™ Delivers Automatic, Non-Contact Rim Width
- Acquisition Split Weight Mode, Allows Exact Placement of Weights Behind Spokes

INCLUDES: Setup and Training

WARRANTY: 1 Year Parts and 6 Months Labor



Manatec



DL-65 DSP C Wheel Balancer

SKU **OSB**
MANDL65-DSPC

1,649⁹⁹

- Static and Dynamic Balancing
- Automatic Start with Wheel Guard Closure
- Unbalance Recalculation
- Self-Calibration
- 7 Modes of Alloy Wheel Functions
- Normal and Fine Measurement
- Motor Power: 0.35 HP
- Maximum Wheel Diameter: 39"

User Setup Required

WARRANTY: 1 Year Parts



Customer Responsible For Offloading, Liftgate Service Available.

For OSB, Call 901-300-4878

• Free Delivery in 48 Continental United States • Specifications Subject to Change without Notice or Liability • Equipment Lead Times and Shipping May Vary • Customers Responsible for Offloading Equipment Upon Arrival • Leasing Terms Available, Ask Your AutoZone® Commercial Sales Manager.

Prices subject to change without notice. Prices do not include applicable taxes, vehicles, tires, rims, installation or optional equipment as shown. Please do not return purchases to the store. For information regarding warranty, repair, or any questions or concerns, call 901-300-4878.

TIRE SERVICE

TPMS Tools

VT37 TPMS Sensor Activation and Programming Tool

SKU **1343925** **279⁹⁹**
ATEVT37-0000

- Search TPMS Sensor Replacement Part Numbers
- Test Keyfob Signal Strength/Battery Status
- Install and Service TPMS Retrofit Kits



Includes 2 Years Software Updates and 1 Year Warranty



VT47 TPMS Programming Tool

SKU **OSB** **729⁹⁹**
ATESM47-12SC

- TPMS Sensor Part Number Look-Up (OE and Aftermarket)
- Change Placard Values When Swapping Tire Sizes
- Includes: 12 Dual Band Sensors with Both Metal and Rubber Valve Stems



Includes 12 Dual Band Sensors

VALUE: \$299.88

Includes 5 Years Software Updates and 1 Year Warranty



For OSB, Call 901-300-4878

FUNCTIONALITY	VT37	TS47	TS57	VT67
Reads, Diagnoses and Activates 100% of OE and Aftermarket Sensors, Including 2022 Coverage	✓	✓	✓	✓
VIN Barcode Scanner to Select Make, Model and Year			✓	✓
Wi-Fi and Real-Time Updates Powered by Live Sensor™		✓	✓	✓
Programs Aftermarket Sensors (Including EZ-Sensor® and All Leading Brands)	✓	✓	✓	✓
Secure Gateway (SGW) Ready for Stellantis Vehicles and Others				✓
Provides Direct (OBD, Auto, Manual) and Indirect TPMS Relearn Procedures	✓	✓	✓	✓
98.6% TPMS Reset Coverage, Including Bonus ECU Reset Coverage in <2 Min. (OBD Connectivity)		✓	✓	✓
ECU Unlock for Toyota, Scion and Lexus Models (Closed Loop)		✓	✓	✓
OE and Aftermarket TPMS Sensors and Service Kits Part Number Look-Up	✓	✓	✓	✓
Save, Manage and Edit Customer Jobs and Reports on the Cloud				✓
Retrieves, Decodes and Clears TPMS DTCs		✓	✓	✓
Tire Management, DOT, Tread Reading and More		✓	✓	✓

Dual Band TPMS Sensor

SKU **OSB** **24⁹⁹**
SIMSM-1SC

- Dual Band TPMS
- Aluminum and Rubber Valve Included
- 98% Coverage Tested and Validated in USA
- Live Tech Support



Bluetooth Pre-Programmed Sensors

SKU **OSB** **59⁹⁹**
SIMSM-BLE

- Tesla, OE Like
- Future Proof, OE Like
- Plug and Play
- Black Valve
- Live Tech Support



Wheel Stud Tools

8 Piece Wheel Stud Alignment Guide Kit

SKU **818715** **34⁹⁹**
24233

- Makes the Job Faster and Easier Allowing the Tech to Safely Position the Wheel Prior to Installing the Wheel Bolts
- Applications: Mercedes-Benz, BMW, Audi, VW, Porsche, Fiat and Dodge
- Sizes Included: 12 mm x 1.5, 12 mm x 1.25, 14 mm x 1.25 and 14 mm x 1.75



Wheel Stud Installers

SKU **339123** **14⁹⁹**
24234

- Works with Hubs, Rotors and Axles on Both Front and Rear Wheel Drive Vehicles
- Prevents Damage to Lug Nut or New Stud
- Designed to Fit Studs Up to 14 mm or 9/16"



Truck Wheel Stud Installer

SKU **339117** **14⁹⁹**
24235

- Designed to Work on Truck Wheel Studs Up to 22 mm (7/8") in Diameter
- Use with an Impact Wrench or Ratchet



Wheel Stud Installer Set for Cars and Trucks

SKU **1544687** **24239**

- Set Includes 24234 and 24235



24⁹⁹
 REG. \$29.98

SAVE \$4
 OVER

When You Buy the Set

TIRE SERVICE

TO ORDER, contact your Commercial Sales Manager or go to AutoZonePro.com

TIRE SERVICE

CALL FOR PRICE

AUTEL MAXITPMS

CALL FOR PRICE

MaxiTPMS® TS508 WiFi Kits

- Update software directly from tool-enabled Wi-Fi
- Quick Mode & Advanced Mode Options
- Read/Activate/Relearn All Known Sensors
- Detect & Display TPMS System Faults
- Display Vehicle-Specific Relearn Procedures; Perform OBDII Relearns
- Placard Value Reset on Supported Vehicles
- 2 Programming Options: MX-Sensors Only
- FREE Software for lifetime of tool
- 4 1-Sensors & Metal Valve Included



SKU #1413611 Part #700190 \$249
 SKU #1538300 Part #700330
 • 20 Rubber 1-Sensors Included
 • 20 Metal 1-Sensors Included



Part #700190 SHOWN



- ### MaxiTPMS® ITS600PRO1
- SKU #1140847 | Part #ITS600PRO1
- Complete TPMS Service and Diagnostics Tablet
 - 5.5 Inch Color Touchscreen/Android 9.0 OS
 - Activates, Reads and Relearns All Known Sensors
 - On-Tool DOT Tire Registration
 - 2 MX-Sensor Program Modes

AUTEL
THE SMARTER CHOICE
FIND OUT WHY



- ### MaxiTPMS® MX-Sensor BLE
- SKU #1366285 | Part #300100
- Pre-programmed Bluetooth Low Energy TPMS sensors for Tesla 3/Y/S/X models
 - Tesla-ready: Just Fit and Go
 - Future-proof: programmable with Autel TPMS tools for the latest BLE-equipped vehicles

- ### MaxiTPMS® 1-Sensor
- SKU #31745 | Part #1SENSOR
- Combined Frequency: 315MHz & 433MHz
 - Interchangeable Valve Stems (rubber included)
 - Program to Replace 99% of OE Sensors
 - Fast valve stem swap



- ### MAXITPMS® 1-SENSORM
- SKU #1064478 | Part #1SENSORM
- Same as 1-Sensor with Aluminum stem



- ### MaxiTPMS® 1-Sensor 20-Pack (R)
- SKU #370328 | Part #300010
- Bulk pack of 20 1-Sensors with Rubber Valves



- ### MaxiTPMS® 1-Sensor 20-Pack (M)
- SKU #1107286 | Part #300060
- Bulk pack of 20 1-Sensors with Aluminum Valves

- ### MaxiTPMS® 1-Sensor 240 Pack
- SKU #1089240 | Part #300050
- Bulk pack of 240 1-Sensors with Rubber Valves



- ### MaxiTPMS® 1-Sensor 100 Pack
- SKU #1128315 | Part #300070
- Bulk pack of 100 1-Sensors with Rubber Valves



- ### MaxiTPMS® TS900
- SKU 1337325 | Part #TS900
- Activate, Read, and Relearn ALL known TPMS sensors, including Tesla OE sensors
 - Program universal Autel 1-Sensors to replace 99% TPMS sensors

- Compatible with BLE TPMS sensors and Autel BLE Sensor for Tesla vehicles
- Features Android 11 operating system and 64GB storage memory
- All Systems Diagnostics with bi-directional controls, Active Tests & Special Functions

- ### MaxiSYS® MS906PRO-TS
- SKU #1207797 | Part #MS906PROTS

- AutoVIN 2006+/AutoSCAN
- 21 Service Functions • Wi-Fi Software Updates
- Eligible for ADAS Software Upgrade
- Advanced Coding & Adaptations



NEW HEAVY DUTY TPMS SERVICE



- ### MaxiTPMS® ITS600 CV
- SKU #1573165 | Part #700420
- Complete TPMS Service tool for Commercial Vehicles
 - Industry-leading coverage for TPMS-enabled Trucks, Trailers, Buses
 - Program Autel MX-Sensor CVS-A01433 MHz Sensor to replace OE and programmed aftermarket sensors
 - Separate Tractor & Trailer interfaces display up to 46 wheels & 12 axles
 - Includes Deutsch 6 and 9-pin, and UNI-U-4 DLC adapters

MX-Sensor CVS-A01 TPMS Sensor for Commercial Vehicles

- SKU #1573139 | Part #300170
- Includes metal band to attach sensor to rim, compatible with rims sized 14 to 24.5-inches

SKU #1573138 | Part #300190

 - Includes fabric band to attach sensor to rim, compatible with rims sized 14-17.5-inches

SKU #1573141 | Part #300210

 - Includes metal band to attach sensor to rim, compatible with rims sized 17.5 to 24.5-inches



AUTEL

Inflators

OEM TOOLS

Digital Tire Inflator

SKU 802198 24412 **99⁹⁹**

- Easy-to-Read Backlit LCD Display
- 4 Units of Measure (psi, Bar, kPa, kgf)
- Measuring Range: 0 to 175 psi (0 - 12 Bar)
- Accuracy: +/-1.2 psi Up to 58 psi, +/-2.3 Between 58 psi and 145 psi Inclusive, +/-3.6 psi Greater Than 145 psi
- High Air Flow Saves the Technician Time



Dial Tire Inflator

OEM TOOLS

Dial Tire Inflator

SKU 301772 24380 **89⁹⁹**

- Clear and Easy-to-Read 80 mm 180 psi Gauge
- 3-In-1 Function: Inflate, Deflate and Measure Tire Pressure
- Increased Accuracy to Improve Tire Performance and Prevent TPMS Comebacks



3.5" Digital Tire Inflator with Hose

Astro

3.5" Digital Tire Inflator with Hose

SKU 1268419 AST3018 **99⁹⁹**

- 21" Stainless Braided Hose
- Dual AAA Battery Powered Design
- Backlit LCD Digital Read-Out
- Includes Batteries



Airstation

Branick

Wall Mount Airstation

SKU OSB BRA155 **949⁹⁹**

- Four 25' Hoses with Lock-On Chucks
- Large Easy-to-Read Digital Display
- High Flow Valve for Faster Operation
- Max. Inlet Pressure: 218 psi
- Max. Operating Pressure: 145 psi
- Accuracy: +/- 0.7 psi
- Increments: 1 psi



For OSB, Call 901-300-4878

Bead Seater

OEM TOOLS

5 Gallon Bead Seater

SKU 526505 24449 **99⁹⁹** REG. \$129.99 **SAVE \$30**

- Seats Beads on All Tires, from Small 4" Tires to 24-1/2" Truck Tires
- Operates on Standard Shop Air; Max. 120 psi



Offer Good While Supplies Last Through December 31, 2025

Air Chuck

Dual Foot Air Chuck with Comfort Grip Handle

SKU 802201 24413 **24⁹⁹**

- Tilt Lock Feature Locks onto the Valve



Air Chuck with Comfort Grip Handle

SKU 802200 24414 **19⁹⁹**

- Sealed-Ball Air Chuck is Extended 1" from Handle to Allow Access to Tight Areas



Prices subject to change without notice. Prices do not include applicable taxes, vehicles, tires, rims, installation or optional equipment as shown. Please do not return purchases to the store. For information regarding warranty, repair, or any questions or concerns, call 901-300-4878.

TIRE SERVICE

Mount/Demount Heads	Fits	Models	OE Part Number		Fits	Models	OE Part Number
Red Nylon Mount/Demount Head SKU 1137811 44⁹⁹ SHA35034 	Hunter	TC250, TC300, TC325, TC350, TC2000, TC3250, TC3500, TC3000 and TC3100 Series	221-615-2-13	Nylon Mount/Demount Head without Hardware SKU 1125892 44⁹⁹ SHA35033 	Accuturn	3602, 3602HP, 4260, 4560MR, 4602, 5602 and 5602 HP	2002433, 14024784
	Accuturn	(Requires Adapter) 220A, All Other Models Require 102765 Adapter	SM102529		Hofmann	1520, 1565, 1620, 1625EM, 3300, 3300EM, 1270, 2300, 3000 and 3000GP	4024784, ST0024335
	Ranger	R980X Rev A Models, R980XR/NXT, R30XLT, RX-850/950-B Models, R23/23ST, R26ST/26EX, R745 and R710 Models ONLY. Require RAN5150524 Adapter	5150523		John Bean	EHP System IVE, IV, III, IIE	2433, EAA 0247G20A
Nylon Mount/Demount Tapered Hole Head with Hardware SKU 1137818 39⁹⁹ SHA38306 	Coats	5030, 5040, 5045, 5050, 5060, 5065, 6050, 6060, 6065, 7050, 7055, 7060, 7065, 7660, 7665, 50X, 60X, 70X, 80X, GTS, RC45, RC55, Maxx50, 70 and 80	8183061	Nylon Mount/Demount Head with Round Hole Kit SKU 1137815 99⁹⁹ SHA35030 	Snap On	All Models	2433, EAA 0247G20A
	Baseline	BL200, BL300, BL400 and BL500	8183061		All Tool	All Models	2008402
Low Profile Mount/Demount Head SKU 1125869 64⁹⁹ SHA35038 	Coats	Replacement for Coats 8184432. For use on Models RC100, RC150, RC200, 5030, 5035, 5040, 5045, 5050 Series, 5060 Series, 5065 Series, 6050, 6060, 6065, 7050, 7055, 7060, 7065, 7655, 7660, 7665, BL200, BL300, BL400 and BL500	8184432	Coats	Early 5060, Early 5060A, Early 5060E, Early 5060AX, Early 5060EX, 9010A, 9010E, 9024E, Some APX80, APX80A, APX80E, APX90, APX90A, APX90E, RC-1, RC1, RC-5A, RC5A, RC-15A, RC15A, RC-20AA, RC20AA	83008402, 83008403	
Nylon Mount/Demount Head with Hardware SKU 1442589 44⁹⁹ TMRTC14024784 	Accuturn	3602, 3602HP, 4260, 4560MR, 4602, 5602 and 5602 HP	2002433	Nylon Mount/Demount Head SKU 1125877 39⁹⁹ SHA35031 	CEMB	All Models	3008403, 2008402
	Hofmann	1520, 1565, 1620, 1625EM, 3300, 3300EM, 1270, 2300, 3000 and 3000GP	4024784		Hofmann	12SE, 22SE, 1510, 1610, S410	8314813
	John Bean	EHP System IVE, IV, III, IIE	24335		Hunter	Not for use on Hofmann: 1550, 1620 & 1625	RP11-8-11400327, RP11-8314813, 83008403
	Snap On	All Models	24335		Giuliano, Corghi, SICE	Fits Many Hunter TCX series	Giuliano – 8314813 Corghi – 4-120129B SICE – 3008403

Bead Lifting Tool



20" Bead Lifting Tool - 3 Pack

SKU **1142616** **19⁹⁹**
26036

- For Use with Any Make of Tire Changer and Tire Combination
- Curved End to Prevent Tire Damage
- Can Be Used for Both the Removal and Mounting of Tires
- Heat-Treated for High Strength and Durability



Rim Protectors



12 Pack Plastic Insert Rim Protectors for Coats Stainless Steel Mount/Demount Head

SKU **1400044** **19⁹⁹**
TMRT1182963

- For Coats Stainless Steel Mount/Demount Head Coats 8182961 (2 Pk.) RC1, 5, 10, 15, 20 8182963 (12 Pk.) Early 5060, 5030, 5040, 5050, 5060, 5065 5070, 6050, 6060, 6065, 7050, 7055, 7060 7065, 7655, 7660 and 7665



Hybrid Duckhead Tail - 2 Pack

SKU **1442586** **44⁹⁹**
AMM8560896102

- Designed to Float Across the Rim, Decreasing the Stretching of the Bead
- Compatible with Hybrid Duckhead® Mount/Demount Tool (85608959)
- Compatible with All X-Series and RC Series That Have Hybrid Duckhead® Mount/Demount Tools



TIRE SERVICE

TO ORDER, contact your Commercial Sales Manager or go to AutoZonePro.com

TIRE SERVICE

Non-Marring Lug Nut Sockets

1/2" Drive 17 mm Mercedes-Benz® Flower Lug Bolt Impact Socket
SKU **081308** **19⁹⁹**
24469

- Designed Specifically for 17 mm, Convex "Flower" Shaped Mercedes Lug Bolts



3 Piece Extra Thin-Wall Wheel Nut Protector Impact Socket Set
SKU **094646** **29⁹⁹**
25583

- Blue - 17 mm/11/16"
- Gold - 19 mm/3/4"
- Red - 21 mm/13/16"



3 Piece Super Strength Wheel Nut Impact Socket Set
SKU **347212** **39⁹⁹**
24227 REG. \$44.99

- Blue - 17 mm/11/16"
- Gold - 19 mm/3/4"
- Red - 21 mm/13/16"

SAVE \$5



Offer Good While Supplies Last Through December 31, 2025

OEM TOOLS®

9 Piece Thin-Wall Wheel Protector Impact Socket Set
SKU **965856** **99⁹⁹**
24224

- Sizes: 3/4", 7/8", 13/16", 15/16", 1", 1-1/16", 17 mm, 19 mm and 21 mm



1/2" Drive Non-Marring Lug Nut Socket Set
SKU **OSB** **39⁹⁹**
68945

- Serves 17 mm, 19 mm, 21 mm and 22 mm Lug Nuts
- Non-Marring Sleeve Prevents Damage of Lug Nuts and Wheel Rims
- CR-MO Steel Construction for Strength and Durability



For OSB, Call 901-300-4878

Lug Nut Sockets

OEM TOOLS®

Master Lug Nut Kit
SKU **1190208** **68919**

- Includes: 2 Socket Sets for Removing, Locking, Damaged and Undamaged Lug Nuts on Most Vehicles
- Ideal for Removal of Warped and Mangled Chrome-Cap Style Lug Nuts
- Easily Removes Locking Lug Nuts on Most Aftermarket Wheels



109⁹⁹

REG. \$129.98

SAVE OVER \$19

When You Buy the Kit

16 Piece Locking Lug Master Key Set
SKU **626107** **89⁹⁹**
24447

- Easily Removes Locking Lug Nuts on Most Aftermarket Wheels
- Thin-Wall Sockets Prevent Damaging Wheels and Lugs
- Hex-Head Design Fits Most Lug Wrenches as well as 13/16" and 7/8" Sockets



4 Piece Deep Thin-Wall SAE and Metric Impact Flip Socket Set
SKU **965857** **39⁹⁹**
24223

- Includes: 3/4" to 13/16", 19 mm to 21 mm and 7/8" to 15/16" Sockets and 3" Extension



5 Piece 1/2" Drive Flip Socket Set
SKU **1125891** **39⁹⁹**
25555

Half Metric Sizes for Removal of Warped and Mangled Chrome-Cap Style Lug Nuts

- Durable CR-MO Flip Socket Set
- Includes: 18.5 mm x 19.5 mm, 19 mm x 21 mm, 21 mm x 21.5 mm, 22 mm x 22.5 mm and 1/2" Drive Extension



Torque Limiting Sets

OEM TOOLS®

8 Piece Torque Limiting Extension and Thin Wall Socket Set
SKU **347217** **99⁹⁹**
24228

- 4 Extension Bars: 65 Ft/Lb. (90Nm), 90 Ft/Lb. (120 Nm), 100 Ft/Lb. (135 Nm) and 110 Ft/Lb. (150 Nm)
- 4 Deep Sockets: 17 mm, 19 mm, 21 mm, 22 mm



5 Piece 1/2" Drive Torque Limiting Extension Set
SKU **965858** **79⁹⁹**
24220

- Quick, Simple and Accurate
- Helps Prevent Lug Stud/Nut Damage and Warped Rotors
- Includes 1/2" Drive Extensions: 65 Ft/Lb., 80 Ft/Lb., 100 Ft/Lb., 120 Ft/Lb. and 140 Ft/Lb.
- Made with Flexible Chromoly Steel that Stops Turning When the Required Torque is Reached
- Comes in a Sturdy Blow Mold Case



Torque Wrenches

OEM TOOLS®

3/8" Drive (10-80 Ft/Lb.)
SKU **177722** **69⁹⁹**
25694

1/2" Drive 10-150 Ft/Lb.
SKU **012651** **79⁹⁹**
25689

1/2" Drive 25-250 Ft/Lb.
SKU **177715** **114⁹⁹**
25695



25695

1/2" Drive Undercar Torque Wrench
SKU **OSB** **329⁹⁹**
CEN97354A

- Unique One-Way Design Cannot Be Used as a Breaker Bar (thus Preventing Damage)
- High Contrast Laser Markings for Easier Reading
- Rubber Over-Mold Lock Ring for Better Grip
- Head and Handle Covers for Increased Durability
- Range: 25 to 250 Ft/Lb. (43.4 to 348.4 Nm)
- Length: 23.3"



For OSB, Call 901-300-4878

Prices subject to change without notice. Prices do not include applicable taxes, vehicles, tires, rims, installation or optional equipment as shown. Please do not return purchases to the store. For information regarding warranty, repair, or any questions or concerns, call 901-300-4878.

AZG0425

105

TIRE SERVICE

Wheel Weight Kits

- Steel Weights are More Environmentally Friendly Compared to the Lead Weight Alternative
- Premium Powder Coated Finish Resists Chips and Scratches Which Helps Prevent Damage and Corrosion to Wheels

Complete Wheel Weight Kit with Floor Rack

SKU **1392466**
68953A

- Includes 78 Boxes of Coated Clip-On Wheel Weights
- ALFE, LHFE, MCFE, PFE, TFE, ENFE, FNFE and IWFE
- 25 Weights per Box
- All Metal Floor Rack

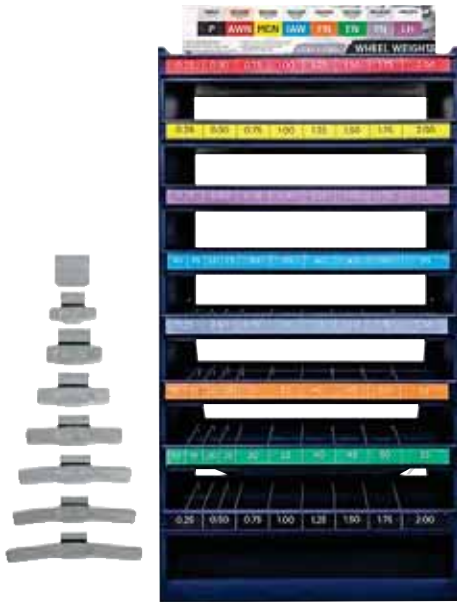

- ALFE Steel
- LHFE Steel
- MCFE Steel
- PFE Steel
- TFE Steel
- ENFE Steel
- FNFE Steel
- IWFE Steel

999⁹⁹

REG. \$1,609.21

SAVE OVER **\$609**
When You Buy the Kit

Wheel Weight Starter Kit with Floor Rack

SKU **1339729**
OEMREPLENKITA

- Includes: 18 Boxes of Coated Clip-On Wheel Weights
- ALFE, MCFE and PFE in the Most Popular Sizes
- 25 Weights per Box
- All Metal Floor Rack

- ALFE Steel
- MCFE Steel
- PFE Steel

549⁹⁹

REG. \$631.81

SAVE OVER **\$81**
When You Buy the Kit

OEM TOOLS®

Adhesive Wheel Weight Starter Kit with Stand

SKU **1392467**
68955A

- Includes: 4 Boxes and 2 Rolls of Adhesive Wheel Weights
- 3 Boxes of Strips, .25 Oz. .50 Oz. and 1.00 Oz.
- 1 Box of .25 Oz. Strips, Black
- (2) 10 Lb. Rolls of .25 Oz. and .50 Oz.
- Wheel Weight Dispenser Stand



349⁹⁹

REG. \$511.93

SAVE OVER **\$161**
When You Buy the Kit

Wheel Weights Only

OEM TOOLS®

Complete Wheel Weight Kit, Weights Only

SKU **1392468**
68954A

- Includes 78 Boxes of Coated Clip-On Wheel Weights
- ALFE, LHFE, MCFE, PFE, TFE, ENFE, FNFE and IWFE in the Most Popular Sizes
- 25 Weights per Box

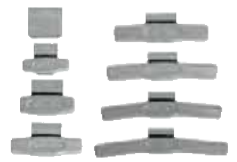

- ALFE Steel
- LHFE Steel
- MCFE Steel
- PFE Steel
- ENFE Steel
- FNFE Steel
- IWFE Steel
- TFE Steel

599⁹⁹

REG. \$1,209.22

SAVE OVER **\$609**
When You Buy the Kit

Wheel Weight Starter Kit, Weights Only

SKU **1392326**
68952

- Includes: 18 Boxes of Coated Clip-On Wheel Weights
- ALFE, MCFE and PFE in the Most Popular Sizes
- 25 Weights per Box

- ALFE Steel
- MCFE Steel
- PFE Steel

149⁹⁹

REG. \$231.82

SAVE OVER **\$81**
When You Buy the Kit

Adhesive Wheel Weight Starter Kit

SKU **1525567**
68956

- Includes: 4 Boxes and 2 Rolls of Adhesive Wheel Weights
- 3 Boxes of Strips, .25 Oz. .50 Oz. and 1.00 Oz.
- 1 Box of .25 Oz. Strips, Black
- (2) 10 Lb. Rolls of .25 Oz. and .50 Oz.



199⁹⁹

REG. \$361.94

SAVE OVER **\$161**
When You Buy the Kit

CALL YOUR COMMERCIAL SALES MANAGER TO ORDER YOUR WHEEL WEIGHTS TODAY

Wheel Weight Tools

Adhesive Wheel Weight Removal/Cutting Tool

SKU **1362016** **29⁹⁹**
25096

- All-In-One Wheel Weight Tool for Removal Installation and Cutting with Precision
- Hammer End with Non-Marring Head Prevents Damage
- Sharp Cutting Edge to Trim Adhesive Wheel Weights
- Jaws Feature a Protected Surface for Non-Marring Removal of Adhesive Wheel Weights
- Anti-Slip Rubber Coated Handle



4 Piece Plastic Scraper Set

SKU **900802** **24⁹⁹**
25513

- Will Not Scratch Paint
- Great for Wheel Weight Removal



OEM TOOLS®

TIRE SERVICE

TO ORDER, contact your Commercial Sales Manager or go to AutoZonePro.com

TIRE SERVICE

Adhesive Weights



SKU	Part#	Size	Type	Description	Price
19304	23200*	.25 Oz.	40 Strips	12 Pieces per Strip, 480 Pieces per Box	52.99
19312	23201*	.25 Oz.	10 Lb. Roll	640 Pieces per Box	63.99
19294	23203*	.50 Oz.	24 Strips	10 Pieces per Strip, 240 Pieces per Box	63.99
19310	23202*	.50 Oz.	10 Lb. Roll	320 Pieces per Box	74.99
1339726	23214	1.00 Oz.	16 Strips	7 Pieces per Strip, 112 Pieces per Box	67.99
1339728	23216	.25 Oz.	30 Strips	Black, 8 Pieces per Strip, 240 Pieces per Box	37.99



STORE STOCKED*

Wheel Weight Racks



Adhesive Wheel Weight Dispenser Stand
SKU 1363723
23209

149⁹⁹

- Easy Assembly
- Can Be Secured to Workshop Floors
- Holds 2 Rolls
- All Metal Construction

Mounting Hardware and Wheel Weights Not Included



Metal Wheel Weight Floor Rack
SKU 1328027
PLM486-31280

449⁹⁹

- All Metal Construction
- 8 Shelves
- Includes Dividers



Clip-On Wheel Weights

- Easy to Apply and Remain Firmly in Place Once Installed
- Steel Weights are More Environmentally Friendly Compared to the Lead Weight Alternative

- Polymer Coated for the Best Appearance and Exceptional Corrosion Resistance
- 1 Box of 25 Each



STORE STOCKED*

SKU	Part #	Profile	Price
1359082	23246	10 gm. IWFE	3.99
1359087	23248	15 gm. IWFE	5.99
1359077	23271	20 gm. IWFE	7.99
1359098	23273	25 gm. IWFE	9.99
1359089	23277	30 gm. IWFE	11.99
1359075	23283	35 gm. IWFE	13.99
1359040	23290	40 gm. IWFE	14.99
1359084	23294	45 gm. IWFE	16.99
1359043	23297	50 gm. IWFE	18.99
1417848	23301	55 gm. IWFE	20.99
1414943	23310	60 gm. IWFE	22.99
382841	23217*	0.25 Oz. MCFE	9.99
382842	23219*	0.50 Oz. MCFE	10.99
382843	23220*	0.75 Oz. MCFE	11.99
382844	23221*	1.00 Oz. MCFE	13.99
382845	23227*	1.25 Oz. MCFE	17.99
382846	23230*	1.50 Oz. MCFE	17.99
1359096	23244	1.75 Oz. MCFE	20.99
1359053	23253	2.00 Oz. MCFE	21.99
1359056	23257	2.25 Oz. MCFE	23.99
1359052	23260	2.50 Oz. MCFE	26.99
1359095	23262	2.75 Oz. MCFE	28.99
1359036	23263	3.00 Oz. MCFE	31.99
382853	23218*	0.25 Oz. PFE	6.99
382919	23223*	0.50 Oz. PFE	8.99
382920	23224*	0.75 Oz. PFE	8.99
382921	23225*	1.00 Oz. PFE	10.99
382922	23226*	1.25 Oz. PFE	12.99
382923	23228*	1.50 Oz. PFE	14.99
382924	23229*	1.75 Oz. PFE	15.99
382925	23232*	2.00 Oz. PFE	16.99

SKU	Part #	Profile	Price
1359093	23235	2.25 Oz. PFE	23.99
1359086	23236	2.50 Oz. PFE	26.99
1359058	23237	2.75 Oz. PFE	28.99
1359069	23259	3.00 Oz. PFE	31.99
1359038	23239	10 gm. FNFE	3.99
1359073	23242	15 gm. FNFE	5.99
1359092	23265	20 gm. FNFE	7.99
1359068	23267	25 gm. FNFE	9.99
1359071	23269	30 gm. FNFE	11.99
1359063	23270	35 gm. FNFE	13.99
1359083	23272	40 gm. FNFE	14.99
1359057	23274	45 gm. FNFE	16.99
1359094	23275	50 gm. FNFE	18.99
1359070	23276	55 gm. FNFE	20.99
1417552	23309	60 gm. FNFE	22.99
383021	23222*	0.25 Oz. ALFE	9.99
383022	23231*	0.50 Oz. ALFE	10.99
383023	23233*	0.75 Oz. ALFE	14.99
383029	23234*	1.00 Oz. ALFE	15.99
1359044	23243	1.25 Oz. ALFE	18.99
1359078	23247	1.50 Oz. ALFE	19.99
1359076	23249	1.75 Oz. ALFE	20.99
1359037	23250	2.00 Oz. ALFE	21.99
1359048	23252	2.25 Oz. ALFE	23.99
1359074	23287	2.50 Oz. ALFE	26.99
1359047	23289	2.75 Oz. ALFE	28.99
1417555	23302	3.0 Oz. ALFE	31.99
1359054	23238	0.25 Oz. TFE	9.99
1359064	23241	0.50 Oz. TFE	10.99
1359091	23255	0.75 Oz. TFE	12.99
1359049	23256	1.00 Oz. TFE	14.99

SKU	Part #	Profile	Price
1359039	23258	1.25 Oz. TFE	18.99
1359088	23261	1.50 Oz. TFE	19.99
1359080	23264	1.75 Oz. TFE	20.99
1359059	23266	2.00 Oz. TFE	21.99
1359060	23268	2.25 Oz. TFE	23.99
1359079	23284	2.50 Oz. TFE	26.99
1359066	23286	2.75 Oz. TFE	28.99
1359062	23288	3.00 Oz. TFE	31.99
1359097	23251	10 gm. ENFE	3.99
1359067	23254	15 gm. ENFE	5.99
1359081	23278	20 gm. ENFE	7.99
1359051	23279	25 gm. ENFE	9.99
1359045	23280	30 gm. ENFE	11.99
1359090	23282	35 gm. ENFE	13.99
1359061	23293	40 gm. ENFE	14.99
1359050	23296	45 gm. ENFE	16.99
1414944	23299	50 gm. ENFE	18.99
1414942	23300	55 gm. ENFE	20.99
1414945	23308	60 gm. ENFE	22.99
1359055	23240	0.25 Oz. LHFE	9.99
1359085	23245	0.50 Oz. LHFE	10.99
1359042	23281	0.75 Oz. LHFE	12.99
1359072	23285	1.00 Oz. LHFE	14.99
1359065	23291	1.25 Oz. LHFE	18.99
1359041	23292	1.50 Oz. LHFE	19.99
1359046	23295	1.75 Oz. LHFE	20.99
1414947	23298	2.00 Oz. LHFE	21.99
1414946	23303	2.25 Oz. LHFE	23.99
1417553	23304	2.50 Oz. LHFE	26.99
1417556	23305	2.75 Oz. LHFE	28.99
1417554	23306	3.00 Oz. LHFE	31.99

Wheel Weight Profile



Prices subject to change without notice. Prices do not include applicable taxes, vehicles, tires, rims, installation or optional equipment as shown. Please do not return purchases to the store. For information regarding warranty, repair, or any questions or concerns, call 901-300-4878.

TIRE SERVICE

Tire Service Tools

OEM TOOLS®

2 Piece Tire Valve Core Tool Set

SKU **1209377** **12⁹⁹**
22589

- Designed for Removal and Installation of Schrader Style Valve Cores
- Includes: 2" and 5" Tools
- Extra-Long 5" Tool for Hard-to-Reach Applications
- Tough Impact and Solvent-Resistant Acetate Handle



Quick Change Wheel Stud Cleaner Kit

SKU **666299** **69⁹⁹**
CAL16

- Kit Includes: 1/2" Drive Adapter and 6 Brushes
- Brush Sizes: 7/16" (12 mm), 1/2" (13 mm), 9/16" (14 mm), 5/8" (16 mm), 7/8" (22 mm) and 1-1/8" (28 mm)



Tire Tube Test Tank

SKU **291382** **109⁹⁹**
LIS19822

- Tank Features Reinforcement Ribs for Extra Support
- Will Handle Passenger Tire Sizes to Wide Oval and Light Duty Truck Tires
- Dimensions: 31" (L) x 12" (W) x 12" (H)



5025 Tire Spreader

SKU **757051** **449⁹⁹**
BRA00-0161

- Self-Locking Spread Arms
- 4 Horizontal and 2 Vertical Adjustments
- Handles Any Passenger Tire, Including Low Profiles
- Quick Pin Adjustment with Lanyard



Tire Taxi™

SKU **OSB** **89⁹⁹**
DOWJDITT1

- Designed to Transport Car, Light Truck and SUV Tires and Wheels
- Transport 5 Tire and Wheel Assemblies or 8 Tires
- Max. Load: 265 Lb.
- Built-In Locking Caster



For OSB, Call 901-300-4878

Tire Repair

Puncture Repair Set

SKU **OSB** **179⁹⁹**
XTS14-662

- Includes Puncture Repair Procedures Guide and 20" x 32" Shop Poster
- Enough Supplies to Provide More Than 70 Complete Repairs



For OSB, Call 901-300-4878

Tire Repair Cabinet Assortment

SKU **OSB** **649⁹⁹**
XTS14-603

- Deluxe Wall-Mount Cabinet
- Loaded to Complete Over 110 Industry Standard Puncture Repairs
- All the Tools Plus XLIGHT Air Powered Vacuum Carbide Cutters and More



For OSB, Call 901-300-4878

11" Cotton Tire Swab (6 Pack)

SKU **666324** **21⁹⁹**
XTS14-378PK

- Professional Quality Tire Repair Tool
- Use to Spread Mount/Demount Lube on Bead of Tire



Mounting/Demounting Compound (2 Pack)

SKU **OSB** **49⁹⁹**
XTS14-708EPK

- Very Slippery
- No Mixing or Water Required
- Dries Tacky
- Rust Inhibitors
- Works Great with Low Pro, Run Flat and Alloy Wheel Applications
- Mounting and Demounting Compounds to Prevent Damage to Tire Bead



For OSB, Call 901-300-4878

Xtra Slick Tire Bead Lube (2 Pack)

SKU **1281603** **23⁹⁹**
XTS14-753PMPK

- Ready-to-Use Mounting and Demounting Compounds to Prevent Damage to Tire Bead
- Pre-Mixed



8 Oz. Vulcanizing Cement (3 Pack)

SKU **666342** **24⁹⁹**
XTS14-008PK

- Fast Drying
- Can Be Used with Heat Vulcanization



57 Piece Tire Repair Kit

SKU **213119** **39⁹⁹**
26686

- Includes: T-Handle Plug Insert Tool, T-Handle Reaming Tool, Replacement Insert Needle, Long Nose Pliers, Hex Keys, 30 Repair Plugs, Utility Knife, Lubricant, Valve Cores, Valve Caps, Valve Stems and a Valve Core Tool



Refill Plugs for Any OEMTOOLS® Tire Repair Kit

OEM TOOLS®

Repair Plug Refill Sets

- For Use with 26680, 26682, 26683 and 26686



30 Pack
SKU **477063** **9⁹⁹**
26684

100 Pack
SKU **477176** **19⁹⁹**
26685

BRAKE SERVICE

FOR HELP with Selection, Confirm Availability and Ordering Instructions, Call 901-300-4878

BRAKE SERVICE

Brake Lathe Kit



Combination Bench Lathe Kit

SKU **OSB** **13,449⁹⁹**
PCTB-17K

- Features Adapters and Accessories for All Passenger Vehicles and Light Trucks
- Resurfaces Brake Drums and Discs to Exceed OEM Specs for Surface Finish in 1 Pass
- Switch from Drums to Rotors in Seconds
- Includes: Dust Collection System and Side Work Table

On-Site Installation and Training Included

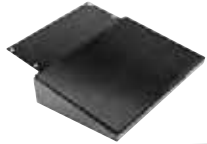

PCT50-4720



PCT50-4280



PCTB-17

WARRANTY: 1 Year Parts and Labor

BONUS VALUE: \$1,749.99

Quick Chuck Kit
PCT50-4250K



With Purchase of PCTB-17K

Offer Good While Supplies Last Through December 31, 2025

Lathe Kit with Trolley



On Car Brake Lathe for Car and Light Truck

SKU **OSB** **18,249⁹⁹**
PCTX15-6ADP

- Plug In, Variable Speed 48v DC Motor
- Performance Plus Cutting Head
- PFM 2.0 Electronics
- Patented One Touch Lateral Run Out (LRO) Compensation
- Cross Platform Compatible Computer and Wiring Harness
- 6 LED On-Board Work Light
- 4 Wheel, 4 Axis, Adjustable Trolley

On-Site Installation and Training Included

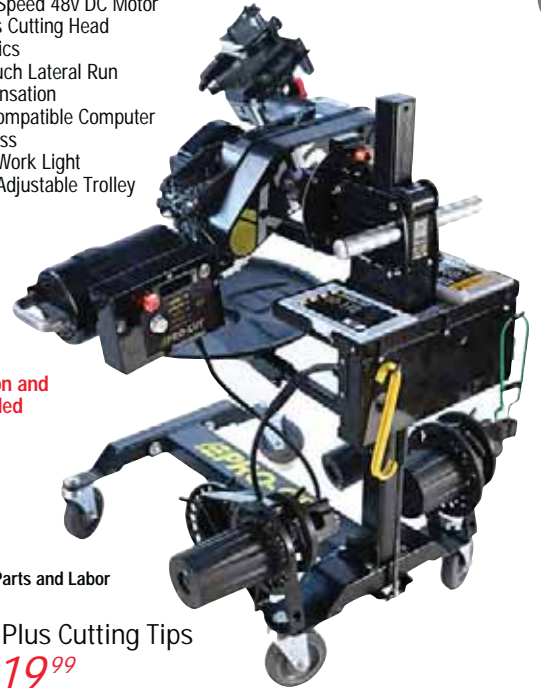

WARRANTY: 2 Year Parts and Labor

Performance Plus Cutting Tips

SKU **OSB** **119⁹⁹**
PCT50-778

- Includes: 6 Tips with Screws

TEST DRIVE BEFORE YOU PURCHASE!

901-300-4878

Ranger®

RL-8500 Combination Brake Lathe with Bench and Standard Tooling

SKU **OSB** **10,624⁹⁹**
RANRL8500

- Complete Kit Includes Lathe, Standard Adapters and Bench
- Provides a Faster, More Accurate and Easier Resurfacing Capability Than Any Other Brake Lathe in Its Class
- Infinitely Variable Speed Controller Able to Turn Rotors and Drums
- Quick-Change Adapter-Plus System with Built-In Springs Eliminates the Need for Conventional Bell Clamps and Cones
- Independent DC Servo Motors Control the Cross-Feed and Spindle-Feed Drives
- One-Cut Micro Finish
- 150 or 200 RPM Spindle

RL-8500XLT HD Combination Brake Lathe with Bench and Standard Tooling

SKU **OSB** **12,799⁹⁹**
RANRL8500XLT

WARRANTY: 1 Year Parts and Labor

Leasing Terms Available,
Ask Your AutoZone® Commercial Sales Manager.



RANRL8500

Shown with Optional Equipment. Accessories Not Included.



Truck Adapter Package

SKU **OSB** **2,599⁹⁹**
RAN5150161

- Super-Duty Truck Tooling Package Consists of an Upgraded 1-7/8" Arbor and a Wide Variety of Adapters
- 32 Piece Set Allows Expanded Coverage to Handle Any Vehicle Up to 1 Ton Trucks
- Fits RL-8500 and RL-8500XLT



Customer Responsible For Offloading, Liftgate Service Available.

For OSB, Call 901-300-4878

Prices subject to change without notice. Prices do not include applicable taxes, vehicles, tires, rims, installation or optional equipment as shown. Please do not return purchases to the store. For information regarding warranty, repair, or any questions or concerns, call 901-300-4878.

BRAKE SERVICE

Brake Service Tools

2 Piece Steel Line Stopper Set

SKU **1331483** **19⁹⁹**
35057

- Seals Steel Lines Found on Fuel, Brake, AC, Power Steering, Transmission Cooling Lines and Banjo Lines
- Prevents Leaks and Contamination
- For Use with All Automotive Fluids
- Fits 3/8", 1/2", 5/16" and Banjo Lines



8 Piece Brake Tool Set

SKU **900827** **59⁹⁹**
27194 REG. \$64.99

SAVE \$5

- Includes: Spring Compressor, Brake Spring Installer, Spring Removal Tool, Brake Retaining Spring Tool, Brake Spring Pliers, 2 Brake Adjustment Spoons and Mini Adjustment Spoon

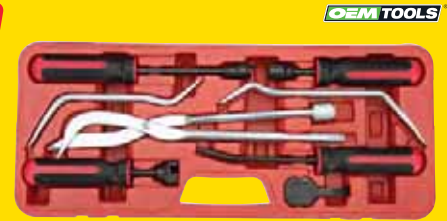

Offer Good While Supplies Last Through December 31, 2025

Brake Cylinder Retainer Remover

SKU **265111** **14⁹⁹**
25268

- Expands and Holds Special Retainer So the Brake Cylinder May Be Removed
- Releases the Spring Clip Retainer That Attaches the Rear Brake Cylinder to Backing Plate



8 Piece Brake Caliper Hanger Set

SKU **312538** **34⁹⁹**
24518

- Prevents Kinking or Premature Failure of Brake Hose
- Keeps Calipers Up and Out of the Way When Servicing Suspension Components, Brakes, etc.
- Hi-Vis Green Powder Coat So You Won't Misplace Them or Leave Them Attached to the Vehicle



8 Piece Manual Brake Gauge Set

SKU **191672** **19⁹⁹**
25266

- Color Coded Brake Gauge Identifies Thickness Levels for Brake Lining Inspection
- Includes Sizes: Red: 2, 3 mm, Yellow: 4, 5, 6 mm, Green: 8, 10, 12 mm
- Red Indicates Must Be Serviced; Yellow Indicates Should Be Serviced; Green Indicates Good



Brake Caliper Brush

SKU **250125** **19⁹⁹**
25435

- Slim Design for Cleaning Brake Calipers and Other Brake Hardware



Multi-Purpose Tubing Bender

SKU **390889** **9⁹⁹**
25179

- Lightweight for Easy Handling
- Makes Left, Right and Offset Bends Up to 90°
- Degrees Marked for Accuracy
- Use with 1/4", 5/16" and 3/8" (4, 6 and 8 mm) Diameter of Mild Steel and Soft Tube Material



1/2" Drive Impact Driver Set

SKU **1142387** **27⁹⁹**
22561

- Easily Break Free Rusted, Corroded and Frozen Screws
- Includes: Impact Driver, Bit Adapter, 8 Impact Bits and Sturdy Blow Mold Case



Rotor/Drum Caliper Kit

SKU **186504** **124⁹⁹**
CEN3K301

- Attaches to Any Caliper on the Lower Jaws
- Outward Facing Anvils to Inspect Drums
- Inward Pointing Anvils to Measure Rotors 8" to 13"
- Range 0 to 6" Digital Caliper Included



Electronic Digital Rotor Gage

SKU **1330687** **109⁹⁹**
CEN3M431

- Easy to See Digital Readout
- Long Arms for All Rotors
- Interchangeable Flat and Pointed Anvils



Disc Brake Rotor Micrometer

SKU **607071** **99⁹⁹**
25367

- .001" Accuracy, .0005" Reading
- Large LCD Display with SAE or Metric Reading
- Manual Power Off/On
- Range: 5.5"/140 mm
- Easy Glide Action
- Hardened Measurement Surface



Carbide Lathe Inserts



SKU	Part Number	Quantity	Application	Description	OEM Part No.	Price
262385	SHA0626	6 Pack	Ammco	Use on Ammco Models 1000, 1001, 3000, 4000, 4100, 7000, 7700	90614-6	29.99
262386	SHA06210	10 Pack	Ammco	Use on Ammco Models 1000, 1001, 3000, 4000, 4100, 7000, 7700	90614-10	34.99
262388	SHA1046	6 Pack	Ammco	Positive Rake Cutting Bits for Ammco Models 3850, 4000, 7000 and 7500 as well as Twin Cutter and 9381 Facing Set	906918-6	49.99
543384	SHA069-10	10 Pack	Pro-Cut	Pro-Cut Style Bit for Use on Model 610 On-The-Car Lathes for Ford. RJ West PFM 9.2, FM900, PFM 9.2DRO Warthog and 9.2DRO	50-742	64.99
262382	SHA40710	10 Pack	FMC	Use on FMC, John Bean, Barrett, Snap-On 67BSD, 67DLX, 67GSA, 69DLX, 701ECF, 601PF, 400, 500, 600, 700 Disc/Drum Lathes	90488, W139, D139	54.99
300786	SHA408-10	10 Pack	FMC/Ranger/Accu-turn	Ranger RL8500 and RL8500XLT Disc and Drum Cutting Lathes. FMC/Barrett Models 400, 500, 600 and 700 Lathes	45016	84.99
262383	SHA06010	10 Pack	Accu-turn	Use on Models: 7700, 8920, 8922, 8944, 8989, 8990, 8991, 8993, 8995 and 8997 Brake Lathes. 3 Cutting Edges	433796	59.99
1142331	SHA065-10	10 Pack	Hunter	Use on Rotor Models: BL500, 501 and 505 Hunter Lathes	221-639-3	89.99

Silencer Bands



Large Solid Rotor Silencer Band (9")

SKU **262396** **14⁹⁹**
SHA94



Small Solid Rotor Silencer Band (6")

SKU **262393** **14⁹⁹**
SHA96

Silencer Clamp

SKU **388821** **64⁹⁹**
SHA70B



Ammco Style Disc Silencer Band with Steel Weights

SKU **262392** **44⁹⁹**
SHA69



Ammco Style 1-3/4" Drum Silencer Band

SKU **262390** **64⁹⁹**
SHA80B



See AutoZonePro.com for More Applications

BRAKE SERVICE

TO ORDER, contact your Commercial Sales Manager or go to AutoZonePro.com

BRAKE SERVICE

Brake Bleeding Tools

OEM TOOLS

Vacuum Pump Tester, Power Steering and Brake Bleeder Kit
SKU 1103570 37070 **49⁹⁹**

- Includes: Vacuum Pump Reservoir Jar with Transfer Lid, Storage Lid, Brake Bleeding Adapter Package, Steering Pump Adapters and Tubing Pump with Vacuum Gauge and Accessories



1 Liter Pneumatic Vacuum Brake Bleeder with Refill Bottle
SKU 1282750 22505 **49⁹⁹** REG. \$59.99 **SAVE \$10**

- Convenient Single-Person Operation
- Effective for Use on Disc/Drum Brakes and Clutches
- Auto-Refill Kit to Simplify the Master Cylinder Refill
- Uses a Standard Workshop Air Supply

Offer Good Through December 31, 2025



Universal Fluid Dispensing Bottle

OEM TOOLS

SKU 568477 24443 **49⁹⁹**

- Refill the Master Cylinder During Vacuum or Manual Hydraulic Brake or Clutch Bleeding and Flushing
- Mounts Securely to Master Cylinder and Clamps
- Capacity: 50 Oz.



BONUS VALUE: \$9.99

Brake Bleeder Wrench (8 mm and 10 mm)
25317



With Purchase of: 24443

Offer Good While Supplies Last Through December 31, 2025

2 Liter Pneumatic Vacuum Brake Bleeder with Refill Bottle
SKU 1361989 22506 **89⁹⁹**

- For Use on Brakes and Hydraulic Clutches
- Convenient Single-Person Operation
- Uses Standard Workshop Air Supply
- Includes: Auto-Refill Kit to Simplify the Master Cylinder Refill and Adapters to Fit Most US and Domestic Vehicles
- Standard and ABS Brake Systems



Brake Bleeder, Steering Pump Bleeder and Vacuum Pump Test Kit
SKU 1142597 27070 **64⁹⁹**

- Kit Bleeds Brakes, Clutches and Other Hydraulic Systems
- Includes: Vacuum Pump Reservoir Jar with Transfer Lid, Storage Lid, Brake Bleeding Adapter Package, Steering Pump Adapters and Tubing



Master Cylinder Adapter Cap Update Kit
SKU 1544667 MITMVA6855 **279⁹⁹**

- Includes Adapter Caps: 2 Honda Specific Caps, 1 Tesla Specific Cap, 1 Nissan/Infinity Hybrid Specific Cap, 2 Ford Caps, 1 Ford/Tesla Specific Cap, and 3 Down Tubes for Caps
- EV/Hybrid
- Update Cap Kit Combined with MVA6850 Covers Most Hybrid and Electric Vehicle Brake Pressure Bleeding Applications
- Expands Our Cap Offerings for Brake Bleeding
- Can Be Used with All MityVac Manual and Pneumatic Pressure Pumps



DIY Reverse Brake and Clutch Bleeder
SKU 459112 PH02104-B **64⁹⁹**

- Easily Bleeds ABS
- Removes Trapped Air
- Attachments to Fit All Vehicles



Silverline Elite Test Kit
SKU 988888 MITMV8500 **144⁹⁹**

- Provides Either Vacuum or Pressure with Equal Precision and Convenience
- Performs Engine Performance Diagnostics, Brake Bleeding, Fluid Transfer, Evacuation, Sampling and More
- Includes Components Needed to Perform Hundreds of Diagnostic and Mechanical Tests



Brake Bleeding Kit
SKU 604208 MITMV6830 **244⁹⁹**

- Compressed Air Operation
- 1.9 Quart Capacity
- Swivel Air Inlet with Quick Disconnect



Pressure Brake Bleeding System

SKU 383099 MITMV6840 **524⁹⁹**

- Large 1.2 Gallon Capacity Dispenser
- Includes 7 Master Cylinder Adapters That Connect to Most U.S., Asian and European Cars and Light Trucks
- Pressure Gauge Indicates Dispensing Pressure
- Utilizes Push-to-Connect, Quick-Change Adapters
- Integrated Manual Relief Valve for Safety



2.5 L Pressure Brake Bleed Kit

SKU 1361996 MITMV7840 **584⁹⁹**

- Utilizes Shop-Air to Produce Pressure for Dispensing and Vacuum for Extracting
- Pressure Control System Safely Maintains Output Pressure Between 20 and 25 psi
- Includes 7 Master Cylinder Adapters That Connect to Most Domestic and Import Cars and Light Trucks
- Conveniently Located On/Off and Flow Control Valve



5 Piece Brake Bleeder Wrench Set

SKU 1442597 VIMBB500 **59⁹⁹**

- Includes: 7 mm to 11 mm
- True Size Hex Openings for Tight Fit
- Satin Chrome Plated High Alloy Steel
- Angles are Designed to Access Bleeder Screws without Removing the Wheel

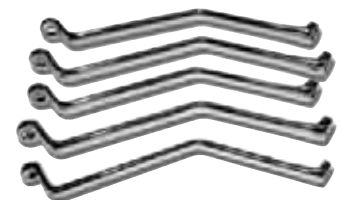

Prices subject to change without notice. Prices do not include applicable taxes, vehicles, tires, rims, installation or optional equipment as shown. Please do not return purchases to the store. For information regarding warranty, repair, or any questions or concerns, call 901-300-4878.

AZG0425

111

BRAKE SERVICE

Disc Brake Tools

18 Piece Disc Brake Caliper Set

SKU **94798** **42⁹⁹**
27113

- Includes Caliper Adapters from 1-3/16" to 2-1/2" – Some Specifically to Service Nissan, Saab and Honda Models
- Includes Right and Left Hand Caliper Rotation Tools
- Left Hand Thread is Useful When Working on 2004-2007 Ford Freestyle, 500, 2008 Taurus and Taurus X Models
- Rust Resistant Finish



37 Piece Disc Brake Service Kit

SKU **1125858**

25107

- Includes: Disc Brake Caliper Tool Set, Pad Spreader, Brake Caliper Brush, 8 Brake Caliper Hangers, 3 Bleeder Wrenches and One-Man Brake Bleeder Kit

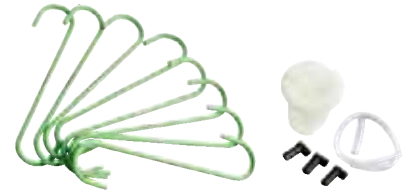

99⁹⁹
REG. \$178.92
SAVE \$78
OVER
When You Buy the Kit

Pneumatic Brake Caliper Tool Set

SKU **1053954** **249⁹⁹**
MSC43050

- Durable Non-Impact Single Piston Shaft
- O-Ring Protected Shaft to Maintain Proper Pressure
- Magnetic Base to Secure Press Adapters
- 15 Piece Press Adapter Set



Dual Piston Press

SKU **900811** **49⁹⁹**
25741

- Designed to Press-In Single and Dual Piston Brake Calipers
- Universal Application on Cars, Light and Heavy Trucks
- Rugged Design for Longer Tool Life



Dual Speedy Pad Spreader

SKU **291420** **84⁹⁹**
LIS25750

- Compresses Dual Brake Pistons Simultaneously
- Makes Dual Piston Pad Replacement a Simple Job



Speedy Pad Spreader

SKU **291417** **64⁹⁹**
LIS24300

- Compresses Disc Brake Pistons in Seconds
- Makes Brake Pad Replacement Easier



Quick Quad Pad Spreader

SKU **080553** **109⁹⁹**
LIS29100

- A Quick Way to Spread Brake Pads and Compress Disc Brake Pistons for Pad Replacement on Single, Double and Quad Piston Calipers
- Simultaneously Compress All 4 Pistons on Quad Piston Applications
- Can Be Used While Caliper is on the Vehicle or Hanging Free



Brake Caliper Press (Standard Size)

SKU **954224** **99⁹⁹**
LNG279

- Size Range is 1.7" to 3"
- Works on Various Single, Dual and Quad Piston Calipers
- 360° Ratchet Swing Allows Access at Any Angle



Brake Caliper Piston Rewind Tool

SKU **1368620** **44⁹⁹**
35058

- Includes a Standard Two-Pin Adapter Compatible with Any Piston Adapter
- Includes a Fully Adjustable 3/8" Drive 2 and 3 Pin Adapter Tool That Fits Most Vehicles
- Powerful Internal Spring to Apply Stable Pressure to the Caliper Piston



Brake Caliper Press (Small Size)

SKU **1400043** **89⁹⁹**
LNG277

- Size Range is 1" to 2.25"



Brake Hub Resurfacing Tool

SKU **013590** **19⁹⁹**
24686

- Quickly Remove Rust on Lug Studs and Rotors on the Hub Assembly
- Use with Drill for a Quick and Easy Job
- Fits All Passenger Cars, Light Trucks and SUVs
- Includes 4 Pads



2 and 3 Pin Brake Rewind Tool

SKU **13592** **29⁹⁹**
24693

- 2 Fully Adjustable to Fit Thousands of Vehicles
- No Need for Multiple Tools
- 3/8" Drive Adapters



3 Pin Side

2 Pin Side



BRAKE SERVICE

TO ORDER, contact your Commercial Sales Manager or go to AutoZonePro.com

BRAKE SERVICE

Sprayers

Red Powder Coated Aluminum Sprayer

SKU **186463** **46⁹⁹**
MSMB8000PL

- 16 Oz. Capacity
- Not for Use with Chlorinated Solvents
- Pressurize Up to 200 psi

Complete Repair Kit for B8000PL

SKU **186467** **29⁹⁹**
MSMBK50



Red Powder Coated Steel Sprayer

SKU **186459** **79⁹⁹**
MSMA1000R

- 32 Oz. Capacity
- Not for Use with Water-Based Products
- Pressurize Up to 200 psi



Repair Kit

SKU **186465** **26⁹⁹**
MSMK10

- Used for MSMA1000R
- Includes All Parts That Can Be Replaced
- All Chemical Resistant Seals



Filler Cap Assembly

SKU **186466** **26⁹⁹**
MSMP156

- For Model "A" Sprayers
- Hand Removable

Hones and Stones

Rotor Flex-Hone®

- Lowers Harmonic Vibrations
- Ideal for New and Resurfaced Rotors and Flywheels

64⁹⁹ each

Fine	Medium	Coarse
SKU 341310	SKU 341298	SKU 341314
BRMRMFH240Z25	BRMRMFH120Z25	BRMRMFH60Z25



Flex-Hone BC 1" (25.4 mm)

SKU **341000** **29⁹⁹**
BRMBC10018

- 1" (25.4 mm) 180 Grit



Adjustable Disc Brake or Small Engine Hone

SKU **531707** **15⁹⁹**
25030

- Includes 3 Medium (220) Grit 3/4" Stones



Brake Fluid Testers

Brake Strip + 100 Ct. Coolant Strip Double Ended with Customer Cards

SKU **1089037** **89⁹⁹**
PH03006-PLUS

- Double Ended Test Strips for Brake Fluid and Coolant
- Use on DOT 3 or 4 Brake Fluid
- Compatible with All Coolant Colors
- Includes: 100 Double Ended Strips and 100 Rating Scale Cards



Double Ended Brake Fluid + Coolant Test Strips, 100 Ct.

SKU **666577** **84⁹⁹**
PH03001-PLUS



BrakeStrip Brake Fluid Copper Test Kit

SKU **289905** **79⁹⁹**
PH03006

- Everything Needed to Test Brake Fluid
- Know within 60 Seconds if it's Time for a Change
- Includes: 1 Tube of 100 Test Strips and 100 Color Pop Rating Cards



Brake Fluid Tester - DOT 3, DOT 4, DOT 5.1

SKU **850067** **29⁹⁹** REG. \$44.99

SAVE \$15

Built-In LED Light to Ensure Tips are in Proper Contact with Fluid

- Easily, Quickly and Precisely Checks the Water Content of 8 Types of Polyglycol-Based Brake Fluids (DOT 3, DOT 4, DOT 5.1, ACDelco DOT 3, Pennzoil, Prestone, Motorcraft and Toyota DOT 3)



Offer Good While Supplies Last Through December 31, 2025

Electronic Brake Fluid Tester

SKU **191687** **29⁹⁹**
25267

- Checks Moisture Content in Any Brake Fluid
- Multi-Colored LED Panel for Easy Recognition
- Automatic Shut-Off
- Calibrated for DOT 4 Fluid
- 1 AAA Battery Included



Fluid Exchanger

Premium Brake Fluid Exchange System

SKU **1407509**
MVC500-8100

3,799⁹⁹

- Includes Brake Adapter Kit
- Pressure and Vacuum Assist
- Portable - Operates on 12 Volt DC
- Complete Brake System Exchange in 10 Minutes
- Adjustable Pressure Regulator Controls Operating Pressure
- Performs Brake Flush Using Pressure and Vacuum Simultaneously



Brake Service Tool

Heavy Duty Hub Drum and Rotor Puller Kit

SKU **1125878** **159⁹⁹**
25106

Use with Impact Wrench to Remove Hubs, Drums and Brake Rotors

- Includes 3 Hub Adapters for Use with Most Common Hub Sizes and Types
- Jaw Spread Up to 12-3/4" with 5" Reach
- Durable Forged Frame Rated to 7 Tons of Pulling Force for the Toughest Jobs
- Drum and Rotor Pulling Arms Feature with Raised Stops for Use with Ratchet Straps (Not Included)
- Easily Adjust the Arms and Set Puller in Place for Tough Pulling Jobs in Tight Spaces
- Includes: Sturdy Blow Mold Case



Prices subject to change without notice. Prices do not include applicable taxes, vehicles, tires, rims, installation or optional equipment as shown. Please do not return purchases to the store. For information regarding warranty, repair, or any questions or concerns, call 901-300-4878.

TOOL STORAGE



- 24" Deep Drawers
- 100/200 Lb. Drawer Capacity
- Non-Slip PVC Drawer Liners
- UV Protected Finish
- Constructed with 16 G Steel Frame
- Lift Latch Drawer Pulls

ALSO AVAILABLE IN



Homak

72" 16 Drawer Rolling Cabinet with Stainless Steel Top – Green

SKU 1267935
HOM72RSPRCSG

2,999⁹⁹

- 72"(W) x 24"(D) x 40"(H)



54" 10 Drawer Rolling Cabinet with Stainless Steel Top – Blue

SKU 1343816
HOM54RSCABSBL

2,399⁹⁹

- 54.5"(W) x 24"(D) x 40.375"(H)



72" 3 Drawer Hutch – Black

SKU OSB
HOM72RSPHUTBK

1,899⁹⁹

- 71.5"(W) x 23.5"(D) x 24.375"(H)



54" Top Hutch – Blue

SKU 1343820
HOM54RSPHUTBL

1,399⁹⁹

- 54"(W) x 23.5"(D) x 24.375"(H)



72" 16 Drawer Roller Cabinet – Black

SKU OSB
HOM72RSPRCBBK

2,799⁹⁹

- 72"(W) x 24"(D) x 39.25"(H)



54" 10 Drawer Rolling Cabinet – Blue

SKU 1442581
HOM54RSPCABBL

2,149⁹⁹

- 54.5"(W) x 24"(D) x 40.375"(H)



72" 12 Drawer Top Chest – Blue

SKU OSB
HOM72RSPCHSTOBL

1,999⁹⁹

- 72"(W) x 23.5"(D) x 21.375"(H)



54" 8 Drawer Top Chest – Black

SKU OSB
HOM54RSCHSTBK

1,499⁹⁹

- 54"(W) x 23.5"(D) x 21.375"(H)



72" 16 Drawer Roller Cabinet – Blue

SKU OSB
HOM72RSPRCBBL

2,874⁹⁹

- 72"(W) x 24"(D) x 39.25"(H)



54" 10 Drawer Rolling Cabinet – Black

SKU OSB
HOM54RSPCABBK

2,149⁹⁹

- 54.5"(W) x 24"(D) x 40.375"(H)



Customer Responsible For Offloading, Liftgate Service Available.

For OSB, Call 901-300-4878

- Free Delivery in 48 Continental United States
- Specifications Subject to Change without Notice or Liability
- Equipment Lead Times and Shipping May Vary
- Customers Responsible for Offloading Equipment Upon Arrival
- Leasing Terms Available, Ask Your AutoZone® Commercial Sales Manager.

TOOL STORAGE

FOR HELP with Selection, Confirm Availability and Ordering Instructions, Call 901-300-4878

TOOL STORAGE



- 24" Deep Drawers
- 100/200 Lb. Drawer Capacity
- Non-Slip PVC Drawer Liners
- UV Protected Finish
- Constructed with 16 G Steel Frame
- Lift Latch Drawer Pulls

ALSO AVAILABLE IN



Homak

44" 8 Drawer Power Service Cart – Gray
SKU 1282738
HOMRSPRO44G **2,099⁹⁹**

- Top Till Includes Full-Extension Gas Struts and a Lockable Security Compartment with an Additional Power Strip to Store and Charge Phones, Laptops and Other Devices
- Equipped with High Security Locking System to Keep Valuables Safe and Secure
- 40.5"(W) x 23.9"(D) x 40.2"(H)

Features 4 Electric Outlets and 2 USB Ports to Efficiently Charge, Store and Organize Power Tools in One Place

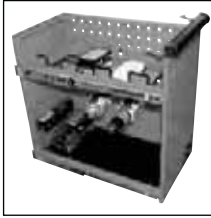

54" 7 Drawer Rolling Workstation - Blue
SKU 1485046
HOM54RWSBL **1,749⁹⁹**

- Durable Stainless Steel Work Surface
- Four (4) 5x2" Casters with a Weight Capacity of 520 Lb. Each: 2 Swivel Locking and 2 Fixed
- 57.5"(W) x 29"(D) x 41"(H)

Features 4 Electric Outlets and 2 USB Ports to Efficiently Charge, Store and Organize Power Tools in One Place



35" 4 Drawer Slide Top Cart – Blue
SKU 1343821
HOM35STCBL **874⁹⁹**
• 35"(W) x 20.625"(D) x 42"(H)



34" Professional 3 Drawer Service Cart - Black
SKU 1267944
HOM34PSCBK **799⁹⁹**
• 34.5"(W) x 16.75"(D) x 39.38"(H)



32" Professional 1 Drawer Service Cart - Blue
SKU 1343817
HOM32PSCBL **499⁹⁹**
• 31.5"(W) x 17.5"(D) x 35.625"(H)



Professional Plastic Service Cart
SKU 1414408
HOMPP06032031 **249⁹⁹**
• Four 4" x 1" Swivel Casters
• Load Capacity Up to 300 Lb.
• Tray-to-Tray Distance of 16.1" for Maximum Storage

41" Top Hutch – Orange
SKU OSB
HOM41RSPHUTO **1,099⁹⁹**
• 40.75"(W) x 23.5"(D) x 24.375"(H)



41" 9 Drawer Rolling Cabinet – Orange
SKU OSB
HOM41RSPRCO **1,599⁹⁹**
• 41"(W) x 24"(D) x 39"(H)

35" 7 Drawer Flip-Top Service Cart - White
SKU OSB
HOM35FTSCWH **1,374⁹⁹**
• 31"(W) x 22.5"(D) x 38.875"(H)



35" Professional 4 Drawer Flip Top Service Cart - Red
SKU 1343822
HOM35PSCR **874⁹⁹**
• 35"(W) x 20.5"(D) x 39.375"(H)



Customer Responsible For Offloading, Liftgate Service Available.

For OSB, Call 901-300-4878

- Free Delivery in 48 Continental United States
- Specifications Subject to Change without Notice or Liability
- Equipment Lead Times and Shipping May Vary
- Customers Responsible for Offloading Equipment Upon Arrival
- Leasing Terms Available, Ask Your AutoZone® Commercial Sales Manager.

Prices subject to change without notice. Prices do not include applicable taxes, vehicles, tires, rims, installation or optional equipment as shown. Please do not return purchases to the store. For information regarding warranty, repair, or any questions or concerns, call 901-300-4878.

AZG0425

115

TOOL STORAGE

28" 7 Drawer - Molded Worktop SKU 477172 24566 **699⁹⁹**

- Dimensions: 28.3"(W) x 18.9"(D) x 40.5"(H)
- Storage Space: 9,505 Cubic Inches
- Fully Sealed Plastic Work Surface is Solvent Resistant
- Integrated Pegboard Provides Additional Storage and Organization



Full Extension
100 Lb.
Ball Bearing
Drawer Slides



Pegboard to
Easily Access
Tools and
Supplies



Sturdy Side
Handles and
4 Bumpers on
Cart Edges

36" 8 Drawer SKU 477134 24565 **999⁹⁹**

- Dimensions: 35.8"(W) x 18.9"(D) x 39.3"(H)
- Storage Space: 12,594 Cubic Inches
- Stainless Steel Work Top is Corrosion Resistant and Easy to Clean



OEM TOOLS



Full Extension
100 Lb.
Ball Bearing
Drawer Slides



Quick Lock
System



Sturdy Side
Handles and
4 Bumpers on
Cart Edges

57" 22 Drawer Professional Combo SKU 662893 24738 **2,999⁹⁹**

- Total Loading Capacity: 2,697 Lb.
- Casters Rated to 880 Lb. Each
- Overall Dimensions: 57"(W) x 24"(D) x 66.5"(H)
- Storage Space: 41,466 Cubic Inches
- Drawer Space: 13,404 Sq. Inches

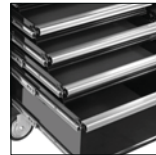

Full Extension
100 Lb.
Ball Bearing
Drawer Slides

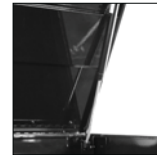

Easy-Opening
Lid with
Gas Struts



Extra Deep
Drawers
Perfect for
Power Tools

SAVE*
\$999

When you buy
the combo

* Savings based on the price of items if purchased separately.

57" 10 Drawer Professional Chest SKU 666333 24737 **1,799⁹⁹**



57" 12 Drawer Professional Cabinet SKU 666300 24736 **2,199⁹⁹**



36" Slide Top 3 Drawer Tool Cart - Green SKU 666298 24731 **999⁹⁹**

- Constructed with a 19 Gauge Steel Shell and 21 Gauge Steel Drawers
- Full Length Anodized Aluminum Drawer Pull
- Shallow Drawer Dimensions: 30"(W) x 18"(D) x 2.9"(H)
- Deep Drawer Dimensions: 30"(W) x 18"(D) x 6.1"(H)
- Overall Dimensions: 36"(W) x 21"(D) x 46"(H)



USB and
Electrical
Outlets



Full Extension
100 Lb.
Ball Bearing
Drawer Slides



Tubular Lock
for Secure
Storage



Heavy Duty
Casters
5" x 2"

Access Your Most Used Tools with an
OEMTOOLS Slide Top Tool Cart



Customer Responsible For Offloading, Liftgate Service Available.

- Free Delivery in 48 Continental United States
- Specifications Subject to Change without Notice or Liability
- Equipment Lead Times and Shipping May Vary
- Customers Responsible for Offloading Equipment Upon Arrival
- Leasing Terms Available, Ask Your AutoZone® Commercial Sales Manager.

TOOL STORAGE

FOR HELP with Selection, Confirm Availability and Ordering Instructions, Call 901-300-4878

TOOL STORAGE

72" Stainless Steel 11 Drawer Cabinet and Upper Cabinet
SKU 1168659 **1,599⁹⁹**
OEM24615

Features:

- Dimensions: 72"(W) x 18"(D) x 71.5"(H)
- Upper Cabinet is 12"(H) x 18"(D)
- Drawer Liners Included

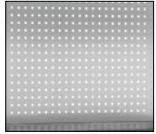

18" Tall Pegboard



Full Extension 100 Lb. Capacity Slides

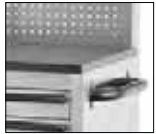

PVC Coated MDF Top



Heavy Duty Casters 5" x 2"



OEM TOOLS

Tear Down Tray

VIKING

Adjustable Mobile Work Table
200 Lb. Capacity
SKU 1485038 **199⁹⁹**
VIK52200

- Adjustable Tray
- Heavy Duty 2" Rubber Composite Swivel Casters
- Multiple Storage Slots, Trays and Insert Grooves Keeps Tools and Parts Organized and Within Reach
- 1" Drawer with Roller Bearing Slides Offer Additional Storage Capacity

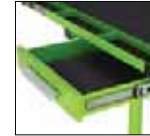

Tools Not Included



Steel Workbenches

Howak

- Black Powder Coat Finish
- Engineered for Quick Assembly
- Built-In Leg Levelers

59" Steel Workbench
SKU 1392321 **579⁹⁹**
HOMGW00550150

- Weight Capacity: 880 Lb.



59" Steel Workbench with 2 Drawers
SKU 1392318 **749⁹⁹**
HOMGW00550170

- High Security Tubular Lock System
- Ball-Bearing Drawer Slides
- Weight Capacity: 1100 Lb.



79" Steel Workbench with 3 Drawers and Wood Top
SKU 1392314 **749⁹⁹**
HOMGS00579030

- 1.5" Wood Work Surface with Top Mat
- Weight Capacity: 440 Lb.



79" Steel Workbench with 3 Drawers
SKU 1392331 **974⁹⁹**
HOMGW00550160

- High Security Tubular Lock System
- Ball-Bearing Drawer Slides
- Weight Capacity: 1100 Lb.



Field Boxes

SHEFFIELD

XL Field Box

- 4 Locking Options for Security
- Compression Fit Lid with Rubber Gasket for Water and Dust Resistance
- Manufactured with Impact, Abrasion and Crack Resistant Copolymer Plastics
- Food Safe and Resistant to Most Acids and Solvents
- External Dimensions: 14" (L) x 9" (W) x 9-1/4" (H)
- Internal Dimensions: 12-5/8" (L) x 6-5/8" (W) x 8" (H)



2 Pack Nested Field Box Set

- Includes: XL Field Box and Standard Field Box
- Standard Size Box:
External Dimensions: 11-1/2" (L) x 5" (W) x 7-1/4" (H)
Internal Dimensions: 9-3/8" (L) x 4" (W) x 6" (H)



Secure Stacking for Reliable Organization

Olive Green

SKU 989242 **36⁹⁹**
12713

Black

SKU 1544659 **36⁹⁹**
12706

Frost

SKU 1544681 **36⁹⁹**
12722

Gray

SKU 1544664 **36⁹⁹**
12755

XL Field Box with Lift Out Storage Tray

- Lift-Out Tray with 8 Compartments

Olive Green

SKU 989216 **34⁹⁹**
12712

Black

SKU 1392328 **34⁹⁹**
12701

White

SKU 1392312 **34⁹⁹**
12721



XL Field Box

Olive Green
SKU 989218 **27⁹⁹**
12710

Black

SKU 1392313 **27⁹⁹**
12700



Customer Responsible For Offloading, Liftgate Service Available.

- Free Delivery in 48 Continental United States
- Specifications Subject to Change without Notice or Liability
- Equipment Lead Times and Shipping May Vary
- Customers Responsible for Offloading Equipment Upon Arrival
- Leasing Terms Available, Ask Your AutoZone® Commercial Sales Manager.

Prices subject to change without notice. Prices do not include applicable taxes, vehicles, tires, rims, installation or optional equipment as shown. Please do not return purchases to the store. For information regarding warranty, repair, or any questions or concerns, call 901-300-4878.

AZG0425

117

TOOL ORGANIZATION

2 Post Socket Trays

6 Piece Socket Tray Sets

- Metric Socket Range: 4 mm to 15 mm (1/4" Drive), 6 mm to 20 mm (3/8" Drive), 10 mm to 27 mm (1/2" Drive)
- SAE Socket Range: 1/8" to 5/8" (1/4" Drive), 1/4" to 1" (3/8" Drive), 3/8" to 1-1/4" (1/2" Drive)
- Includes: 6 Trays - 1/4", 3/8" and 1/2" Drive in Both Metric and SAE



Tools Not Included

Metric Black and Green
SKU 949573
22233

SAE **34⁹⁹**
REG. \$39.99

Metric Black and Orange
SKU 1142583
22418

SAE **34⁹⁹**
REG. \$39.99

Metric Gray and Red
SKU 477209
22413

SAE **34⁹⁹**
REG. \$39.99

SAVE \$5

Offer Good While Supplies Last Through December 31, 2025

3 Piece Socket Trays **OEM TOOLS**

- Includes: 3 Trays - 1/4", 3/8" and 1/2" Drive

SAE Green
SKU 749921
22207

24⁹⁹

Metric Black
SKU 749937
22211

24⁹⁹



Tools Not Included

Magnetic Socket Tray Sets

3 Piece Magnetic Socket Tray Set Metric or SAE

- Includes: 3 Trays - 1/4", 3/8" and 1/2" Drive in Metric or SAE

Blue (Metric) **Metric**
SKU 1149155
22486 **59⁹⁹**
REG. \$74.99

Black (Metric) **Metric**
SKU 1149156
22487 **59⁹⁹**
REG. \$74.99

Red (SAE) **SAE**
SKU 1149183
22484 **59⁹⁹**
REG. \$74.99

Green (SAE) **SAE**
SKU 1149165
22485 **59⁹⁹**
REG. \$74.99

SAVE \$15



OEM TOOLS



Offer Good Through December 31, 2025

6 Piece Magnetic Socket Tray Set - Metric and SAE

- Includes: 6 Trays - 1/4", 3/8" and 1/2" Drive in Both Metric and SAE

Black and Green **Metric** **SAE**
SKU 1331490
22488 **89⁹⁹**
REG. \$99.99

Blue and Green **Metric** **SAE**
SKU 1392463
22461 **89⁹⁹**
REG. \$99.99

SAVE \$10



Black and Red **Metric** **SAE**
SKU 1485048
22460 **89⁹⁹**
REG. \$99.99

Blue and Red **Metric** **SAE**
SKU 1331485
22489 **89⁹⁹**
REG. \$99.99

Offer Good While Supplies Last Through December 31, 2025

- SAE**
- 1/4" Tray Holds 2 Sets of Sockets 1/8" to 5/8"
 - 3/8" Tray Holds 2 Sets of Sockets 3/8" to 7/8"
 - 1/2" Tray Holds 1 Set of Sockets 3/8" to 1-1/4"

- METRIC**
- 1/4" Tray Holds 2 Sets of Sockets 4 mm to 14 mm
 - 3/8" Tray Holds 2 Sets of Sockets 6 mm to 20 mm
 - 1/2" Tray Holds 1 Set of Sockets 10 mm to 27 mm

Tools Not Included

Pro Socket Organizer **OEM TOOLS**

Magnetic Socket Tray

- SKU 082922 **44⁹⁹**
22389
- Store Up to 36 Total Sockets - 1/4", 3/8" and 1/2" Drive
 - Removable Back Panel Allows Magnets to Adhere to Any Magnetic Surface

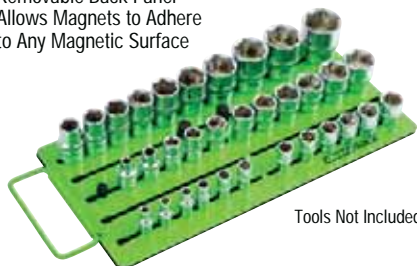

Tools Not Included

Magnetic Socket Organizers **OEM TOOLS**

Portable Magnetic Socket Organizers

- Holds Up to 28 Sockets
- Powerful Magnets Hold Sockets Securely and Attach Organizer to Any Magnetic Surface
- Low-Profile Design Fits Most Toolbox Drawers



3/8" Drive
SKU 1442590
23117 **29⁹⁹**

1/2" Drive
SKU 1414403
23118 **34⁹⁹**



Tools Not Included

Tool Holder **OEM TOOLS**

Magnetic Tool Holder

- SKU 749848 **34⁹⁹**
22212
- 18" Rail with 16 Sliding Clips
 - Multipurpose Clips Hold a Variety of Tools
 - Great for Screwdrivers, Ratchets, Wrenches, Pliers and Other Small Tools
 - Powerful Magnet for Secure Hold
 - Foam Shield to Protect Paint Finishes

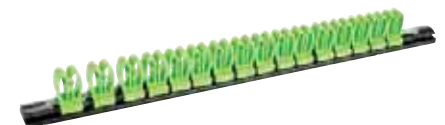

TOOL ORGANIZATION

TO ORDER, contact your Commercial Sales Manager or go to AutoZonePro.com

TOOL ORGANIZATION

Magnetic Trays

4 Piece Magnetic Foldable Tray

SKU 1207890 26052 **24⁹⁹**

- Collapsible Tray Expands from 3/4" to 2" Deep
- Holds Up to 2 Lb.
- Multiple Color Set Keeps You Organized
- Dimensions: 4-1/2" x 4-1/2"



Tools Not Included

Magnetic Trays

- Trays Stick to Most Metal Surfaces
- Ideal for Holding Small Parts and Tools
- Heavy Duty Stainless Steel

5" x 9"

SKU 965834 25117C **14⁹⁹**

- 2 Powerful Magnets with Protective Rubber Coating to Resist Scratching



10" x 11"

SKU 965835 25119 **24⁹⁹**

- 4 Powerful Magnets with Protective Rubber Coating to Resist Scratching



Tools Not Included

Organizers

16 Piece Pliers Holder

SKU 765589 22215 **14⁹⁹**

- 16 Extra-Wide Spaces for Pliers with Rubber Grips
- Vinyl Coating for Lasting Dependability
- Dimensions: 14.0" (L) x 5.2" (W) x 2.5" (H)



Tools Not Included

Drawer Organizer Tray

SKU 749932 22213 **19⁹⁹**

- Rolled Bottom Edges Allow Easy Removal of Small Parts
- Low-Profile Fits in Shallow Toolbox Drawers
- 10-Compartment Tray
- Stackable Design
- Dimensions: 16" (L) x 11" (W) x 1.5" (H)



Magnetic Bit Holders

4 Piece Magnetic Hex Bit Trays

SKU 1284964 24142 **39⁹⁹**

- Each Tray Holds 36 Hex Bits
- Coated Magnetic Trays Adhere to Most Metal Surfaces



Paper Towel Holder

Magnetic Paper Towel Holder

SKU 280376 24952 **19⁹⁹**

- Adjusts to Fit Different Size Rolls
- 3 Rubber-Faced Magnets Won't Scratch Metal Surfaces



Towel Roll Not Included

Wrench Organizers

4 Piece Magnetic Wrench Rails

- Holds 40 Wrenches
- Includes: 4 Rails
- Rail Dimensions: 16.6" (L) x 1.9" (H)

Green SKU 749850 22217 **24⁹⁹**
 Black SKU 765514 22219 **24⁹⁹**



Tools Not Included

2 Piece Wrench Organizing Rails - Black

SKU 213161 22218 **14⁹⁹**

- Holds 35 Wrenches
- Slotted Design Will Fit a Variety of Wrench Types and Sizes
- Rail Dimensions: 23.4" (L) x 1.0" (H)



Adhesive Backs for Quick Attachment

Magnetic Wrench Organizer

SKU 662782 22177 **19⁹⁹**

- Organize Up to 12 Wrenches
- Strong Magnets Will Hold Organizer Upright at Full Capacity
- Non-Marring Foam Backing
- Durable Coated Steel Construction



Tools Not Included

Pro Magnetic Wrench Organizer (Black)

SKU 213098 22176 **19⁹⁹**

- Organize Up to 12 Wrenches
- Strong Magnets Will Hold Organizer Upright at Full Capacity
- Non-Marring Foam Backing
- Durable Coated Steel Construction



Magnetic Wrench Holder and Organizer

- Holds 10 SAE or Metric Wrenches
- Magnetic Base Attaches to Your Tool Box, Tool Chest, Cart or Metallic Peg Board
- Dimensions: 9-1/4" (L) x 1-1/4" (W) x 2" (D)

Green SKU 1331491 22512 **14⁹⁹**



Black SKU 1331501 22513 **14⁹⁹**



Tools Not Included

Prices subject to change without notice. Prices do not include applicable taxes, vehicles, tires, rims, installation or optional equipment as shown. Please do not return purchases to the store. For information regarding warranty, repair, or any questions or concerns, call 901-300-4878.

HEAVY DUTY

Scan Tools

TEXA Diagnostic Kits

- World Class US-Based Support, with the Most Complete Vehicle Coverage
- Lifetime Repair or Replacement Equipment Warranty with Current Software Subscription
- Continual Updates on All Makes and Models with Current Software Subscription

Axone Light Truck Diagnostic Kit

SKU **OSB**
TEXAXLTHDTRK **4,999⁹⁹**

- Advanced Diagnostics and OE-Level Coverage for Heavy-Duty Truck, Trailer, and Light Commercial Vehicles
- Includes: AXONE NEMO LIGHT, Suitable for a Large Range Of Environments and the TXT Multihub



Axone Plus Truck Diagnostic Kit

SKU **OSB**
TEXAXPLHDTRK **7,499⁹⁹**

- Advanced Diagnostics and OE-Level Coverage for Heavy-Duty Truck, Trailer, and Light Commercial Vehicles
- Includes: AXONE NEMO PLUS, Suitable for a Large Range Of Environments and the TXT Multihub



Axone Plus Master Fleet Package for Truck/OHW/Car

SKU **OSB**
TEXAXPLMFP **11,999⁹⁹**

- Provides Advanced Diagnostics and OE-Level Coverage for Diverse Fleets Including Car, Truck, Agriculture and Construction Equipment
- Includes: AXONE NEMO PLUS, Suitable for a Large Range Of Environments, the TXT Multihub and the Off-Highway Essential Cable Case



TEXA

For OSB, Call 901-300-4878

Smoke Leak Detector

Dual Evap Smoke Machine*

SKU **OSB**
MSC43065 **1,849⁹⁹**

- For Evap, Turbo/Intake and Heavy Duty Truck Testing*
- For Evap and High Pressure Diagnostic Testing
- Multiple Options for Smoke Injection Include Built-In Internal Compressor, Shop Air and Inert Gases
- Accessories Include: Smoke Hose, Block Off Caps, Exhaust Cone, Schrader Valve Remover/Installer, Evap Service Port Adapter Hose, Smoke Illuminating Flashlight, Smoke Producing Fluid and Bladder



* Heavy Duty Truck Testing Requires MSC43062 Adapter Kit, Not Included (Sold Separately)



Cooling System

Heavy Duty Cooling Kit

SKU **954231**
MSC43306 **529⁹⁹**

- For Use with Freightliner, International, Kenworth, Peterbilt, Mack, Volvo, GMC and Sterling Cooling Systems
- Uses Shop Air to Pressure Check and Vacuum Refill
- 4 Quick-Disconnect Vacuum Attachments Provide Quick Refilling of the Cooling System and Eradicates Airlocks
- Includes: Heavy Duty Vehicle Adapters, Pressure Test Regulator, Vacuum Refill Attachment with Tubing in a Plastic Case



Recovery Machine

Fully-Automatic Heavy Duty R134a Refrigerant Management System

SKU **1407805**
CPSMXHD **7,649⁹⁹**

- For Commercial and Heavy Duty Applications
- 6 CFM Dual-Stage Vacuum Pump
- Large 12.67 CC Twin-Piston Oilless Compressor
- Comes Standard with a 50 Lb. Tank; Upgradeable to 90 Lb.
- Wi-Fi and Bluetooth Enabled



Specialty Tools

NAVISTAR® MAXXFORCE® Fuel Line Disconnect Tool Set - 4 Piece

SKU **004112**
25031 **34⁹⁹** REG. \$49.99 **SAVE \$15**

- For Series 11 and 13 Engines
- Sized to Depress Fuel Release Tabs for Efficient Fuel Line Removal
- 1 Straight and (1) 90° Tool for 11.8 mm Fuel lines; 1 Straight and (1) 90° Tool for 16 mm Fuel Lines



Offer Good While Supplies Last Through December 31, 2025

Heavy Duty U-Joint Puller

SKU **041474**
24538 **134⁹⁹**

- Easily Removes Seized U-Joint Cups on Most Class 7 and 8 Trucks
- Safely Disassemble Drivelines without Hammering or Heating Components
- Does Not Damage the Driveshaft, Yokes, Joints or Bearing Cups
- Bearing Cup Outside Diameter: 1.5" to 2.2"



Automatic Slack Adjuster Release Tool and Wrench

SKU **1207889**
25252 **39⁹⁹**

- 5/16" Double Square Ratchet Has an Angled Head to Give Extra Clearance for Hands
- Side-Mounted Forward/Reverse Lever for Easy Operation
- Speeds Up Installation on Meritor® Heavy Duty Truck Slack Adjusters to Simplify Brake Service



Brake Anchor Pin Press

SKU **1361998**
27090 **159⁹⁹**

- For Removal of Brake Anchor Pins and Bushings on 16-1/2" S-Cam Trailer and Tractor Q Brake Systems
- No Need to Remove the Hub or Dust Shield
- Rigid C-Frame with 10 Ton Capacity
- Manufactured from High Grade Steel for Strength and Durability
- Manual, No Hydraulics Required



HEAVY DUTY

FOR HELP with Selection, Confirm Availability and Ordering Instructions, Call 901-300-4878

HEAVY DUTY

Heavy Duty Wheel and Tire Service

Heavy Duty Truck Wheel Changer

SKU **OSB** **ROTR501PLUS** **23,999⁹⁹**

- Dismount and Mount a Truck Tire in 30 Seconds
- Super Fast Truck Tire Changer
- Adjustable Arm Position
- Max. Tire Diameter: 52"
- Quick Loading

INCLUDES: Set Up and Training

WARRANTY: 3 Years Parts and Labor



Heavy Duty Wheel Balancer

SKU **OSB** **ROTR540** **8,249⁹⁹**

- Designed to Fit Commercial Truck, Light Truck and Passenger Vehicles
- Balance Compact Cars to HD Trucks
- Auto Stop on Top for Weight Position
- Auto Entry of Distance and Diameter
- Integrated Wheel Lift Up to 441 Lb.
- Max. Rim Diameter: 30"
- Max. Tire Diameter: 51"

INCLUDES: Set Up and Training

WARRANTY: 3 Years Parts and Labor



Coats® CHD-6330 Heavy Duty Tire Changer

SKU **OSB** **AMM8006330** **23,049⁹⁹**

- Motor: 2 HP
- Max. Tire Diameter: 63"
- Rim Diameter: 13" to 27"
- 4-Jaw Chuck Allows for Fast and Easy Clamping of Virtually All Rim Styles
- Features Portable Control Station
- Solid, Single Piece Frame for Added Capacity and Dependability

INCLUDES: Manufacturer's Set Up

WARRANTY: 1 Year Parts and 6 Months Labor



Coats® 6450-3D Heavy Duty Balancer

SKU **OSB** **AMM64503DKT1P** **20,499⁹⁹**

- Kit Includes Wheel Lift Plus Lug and Hub Centered Budd Style Adapters
- Dual Calibration Software Stores and Runs Two Independent Sets of Calibrations
- Powerful 1.5 HP Direct Drive Motor Shaves 20 Seconds Off of a Typical 22.5" Spin
- Designed for High Volume Balancing, the Perfect Machine for Delivery Vehicles and Tractor Trailers
- Max. Tire Diameter: 52"
- Max. Tire Weight: 500 Lb.

INCLUDES: Manufacturer's Set Up

WARRANTY: 1 Year Parts and 6 Months Labor



C206 Portable Hand Spin Wheel Balancer

SKU **OSB** **CMBC206** **9,999⁹⁹**

- Dual Voltage Power Supply 12VDC - 110VAC
- Easy Hand Spin System Requires Minimum Effort for Spinning
- Manual Lifting System Can Easily Handle Wheel Up to 550 Lb. (250 Kg)
- Split Program and Optimization Program Wheels for Easy Portability
- Battery Pack for Use When Power is Not Available
- Balancer Works on a 13" Car Wheel up to a Super Single
- Balancer Works on a 13" Car Wheel up to a Super Single
- Includes: 4 Standard Cones and a Truck Cone Kit

WARRANTY: 2 Year Parts and 1 Year Labor



Heavy Duty Truck and Bus Tire Changer

SKU **OSB** **CMBCM27T** **11,999⁹⁹**

- Built-In Wheel Lift
- Operation Controls from a Moveable Control Unit on a Pedestal
- Bi-Directional Rotation
- Adjustable Bead Loosening Roller with Force of Over 4,100 Lb. (1860 Kg)
- Heavy Duty 220V, 1Ph Phase Motor and High Torque Gear Box
- Free Shipping Fully Assembled
- Plug and Play with On-Site Training

WARRANTY: 2 Year Parts and 1 Year Labor



Customer Responsible For Offloading, Liftgate Service Available.

For OSB, Call 901-300-4878

- Free Delivery in 48 Continental United States
- Specifications Subject to Change without Notice or Liability
- Equipment Lead Times and Shipping May Vary
- Customers Responsible for Offloading Equipment Upon Arrival
- Leasing Terms Available. Ask Your AutoZone® Commercial Sales Manager.

Prices subject to change without notice. Prices do not include applicable taxes, vehicles, tires, rims, installation or optional equipment as shown. Please do not return purchases to the store. For information regarding warranty, repair, or any questions or concerns, call 901-300-4878.

AZG0425

121

HEAVY DUTY

Heavy Duty Lifts

- 14,000 Lb. Mobile Column Lift
 SKU **1580895**
CHLCLHM-140 **13,099⁹⁹**
- 110 Volt Charging System
 - Completely Wireless System
 - Adjustable Wheel Carriage Adapts from 5" to 24.5"
 - Integrated Touch-Screen Control Console at Each Column Allows Operation from Any Unit
 - 14,000 Lb. Capacity per Column
 - Includes: Batteries, Fluids and Factory Training

WARRANTY: 2 Years Parts and 1 Year Labor



New AGM Batteries Carry a 2 Year Free Replacement Warranty

27,000 Lb. Heavy Duty Truck Lift

SKU **OSB**
BENHDS27 **24,099⁹⁹**

- Runways Include Rail-Kit for Optional Accessories
- Runways Adjust for Different Tread Widths
- Electric/Hydraulic Power System
- Fully Enclosed Lifting Cables, Safety Locks and Sheaves
- Pneumatic Push-Button Safety Release
- Length: 24-3/4'

WARRANTY: 1 Year Parts and Labor



Customer Responsible For Offloading.

For OSB, Call 901-300-4878

Lifting Equipment

6,000 Lb. Heavy Duty Engine Crane
 SKU **1267948**
AFF3584

- 1,579⁹⁹**
- 4 Different Boom Settings: 3, 2, 1.5 and 1 Ton
 - Rear of Crane: 61.5" Tall and 33" Wide
 - Distance Between Front of Legs: Retracted 23", Extended 28.5"



35 Ton Air Hydraulic Axle Jack
 SKU **954200**
AFF536 **1,869⁹⁹**

- Unique Motor Design Advances Ram to Load Faster
- Air Assisted Lowering and Dual Return Springs Provide Controlled and Easy Descent
- Safety Overload System Prevents Jack from Being Used Beyond its Rated Capacity
- Corrosion Resistant Aluminum and Nylon Composite Air Motor



Locknut Sockets



7 Piece Wheel Bearing Locknut Set
 SKU **1207886**
37385 **99⁹⁹**

- Includes: 55 mm 6PT, 2-3/8" 6R, 2-3/8" 6PT, 2-1/2" 6R, 2-1/2" 6PT, 2-9/16" 6R and 2-3/4" 6R
- Comes with Standard Hex (6PT) and Rounded (6R) Hex Sockets to Fit Many Applications
- For Use with 1/2" Square Drive Ratchet, Breaker Bar or Torque Wrench



5 Piece Budd Wheel Socket Set
 SKU **1207878**
37384 **129⁹⁹**

- 35 mm, 38 mm, 41 mm and 1-1/2" Sockets Feature a Dual Socket Design with a Hex to Remove the Lug Nut and an Internal Square Drive to Remove the Inside Wheel
- 38 mm, 41 mm and 1-1/2" Sockets Each Have a 13/16" Internal Square
- 35 mm Socket Has a 11/16" Internal Square
- For Use with 1" Drive Ratchet, Breaker Bar, Torque Wrench and Impact Wrench



4,400 Lb. Transmission Jack
 SKU **954183**
AFF3180A **1,849⁹⁹**

- Heavy Duty with a Rated Capacity of Over 2 Tons
- Rugged Industrial Grade 4" Casters
- Fully Adjustable Saddle
- Extra-Long 32" Handle
- Safety Chain Included
- 8.5" Low Height
- Convenient Side Tray to Store Small Tools and Parts



10 Ton Air/Hydraulic Service Jack
 SKU **OSB**
AFF3135 **1,969⁹⁹**

- Large, Rugged 4-1/2" Front Wheels and 2-3/4" Rear Casters
- Can Be Operated Manually When Shop Air is Not Available
- Foot-Operated Pump for Quick Lifting Efficiency
- Automatic Overload Safety Valves
- Chassis Length: 61"
- Low Height: 7"
- Width: 18"



Truck Axle Wheel Bearing Sockets

- 3/4" Square Drive
- Constructed with High-Grade Steel for Strength



4", 6 Pt. SKU **466541** **44⁹⁹**
 25482

2-9/16", 8 Pt. SKU **466534** **34⁹⁹**
 25473

4-1/8", 6 Pt. SKU **265085** **49⁹⁹**
 25483

4-3/8", 8 Pt. SKU **466543** **44⁹⁹**
 25485 REG. \$59.99

SAVE \$15

Offer Good Through December 31, 2025

Heavy Duty Stands



22 Ton Heavy Duty Axle Stands (Pair)
 SKU **757098**
24854 **249⁹⁹**

- Min. Height: 12-1/4"
- Max. Height: 19-3/4"
- Adjustable Pin Design
- Features Handle for Transport and Positioning
- Large Shaped Saddles Center Lift Points for Secure Placement



Heavy Duty Truck Oil Filter Wrenches



Small
 SKU **344322** **34⁹⁹**
 25231
 • Range: 4-1/8" to 4-5/8"
 (104 to 118 mm)

Large
 SKU **344324** **29⁹⁹**
 25233
 • Range: 5-1/4" to 5-3/4"
 (134 to 142 mm)

Medium
 SKU **344323** **34⁹⁹**
 25232
 • Range: 4-5/8" to 5-1/4" (118 to 134 mm)

See Page 36 for Promo Chart and Pricing



• Free Delivery in 48 Continental United States • Specifications Subject to Change without Notice or Liability • Equipment Lead Times and Shipping May Vary • Customers Responsible for Offloading Equipment Upon Arrival • Leasing Terms Available. Ask Your AutoZone® Commercial Sales Manager.

Shop Presses

20 Ton Super Duty Air/Manual Shop Press
SKU 1544673 29000 **1,299⁹⁹**

- Fully Welded Construction And Powder-Coated Steel Frame for Unmatched Durability
- Movable Cylinder and 10 Height Adjustments with 4.3" Increments for Operator Versatility
- Glycerin-Filled Pressure Gauge Ensures Precise Pressure Readings Every Time
- Air/Hydraulic Pump Supports Both Manual and Pneumatic Operation (110-120 psi)
- Includes Anti-Slip Steel Blocks and Meets ASME PASE-2019 Standards



30 Ton Super Duty Air/Manual Shop Press
SKU 1525570 29001 **1,499⁹⁹**

- Fully Welded Construction for Exceptional Strength and Durability
- Movable Cylinder for Added Flexibility in Working Position
- Glycerin Filled Pressure Gauge for Accurate Pressure Readings
- Polycarbonate Protective Guard Shield for Maximum Safety Against Shrapnel and Debris
- Air/Hydraulic Pump Supports Both Manual and Pneumatic Operation (110 to 120 psi)
- Includes Anti-Slip Steel Blocks and Meets ASME PASE-2019 Standards

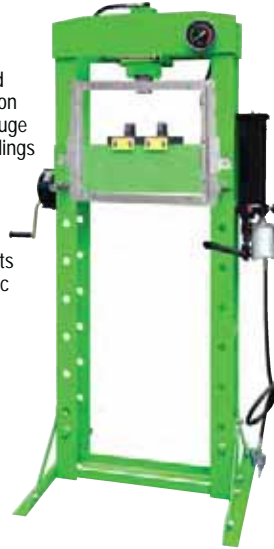

Polycarbonate Protective Guard Shield for Maximum Safety Against Shrapnel and Debris

20 Ton Air Hydraulic Shop Press
SKU 662928 25087 **999⁹⁹**

OEM TOOLS

- Removable Press Cap with 25 mm Hole to Accept OEMTOOLS Press Pin Set (#24813)
- Air/Hydraulic Pump Provides Added Versatility
- Double Speed Pump Greatly Reduces Set-Up and Press Time
- Movable Press Head for Flexibility of Working Positions
- Liquid Filled Pressure Gauge for Accurate Pressure Readings
- Durable Powder Coated Steel Frame
- Includes Press Blocks



Liquid Filled Dual Scale Gauge



Removable Press Cap with 25 mm Hole

10 Ton Hydraulic Bench Top Shop Press
SKU 666327 25088 **499⁹⁹** REG. \$599.99

SAVE \$100

- Removable Press Cap with 25 mm Hole to Accept OEMTOOLS Press Pin Set (#24813)
- Double Speed Pump Greatly Reduces Set-Up and Press Time
- Movable Press Head for Added Flexibility in Working Position
- Liquid Filled Pressure Gauge



Offer Good Through December 31, 2025

20 Ton Shop Press
SKU 300134 24810 **999⁹⁹**

- Stronger Compared to Similar Lighter Weight Shop Presses on the Market
- Includes Press Plates
- Remove and Install Bearings, Gears, U-Joints, Bushings, Ball Joints and Pulleys
- Multi-Position Bed for Work Height Adjustment
- Max. Height: 31.5"
- Max. Width: 21.75"



1-3/4" Diameter Ram



Manually Adjustable Table



H-Frame Press Weighs Over 250 Lb.

Super Heavy Duty

8 Piece Press Accessory Kit
SKU 1525566 29002 **224⁹⁹**

- Includes: 2 Press Plates, 5 Punches and a Bearing Shield
- Sizes 1/2", 3/4", 1", 1-1/2" and 2"
- Capacity: Up to 50 Tons



30 Ton X Style Press Plates
SKU 1544680 24808 **124⁹⁹**

- For Use on All Presses Up to 30-Ton Capacity
- "X" Type Design for Use in Many Different Pressing Operations
- 1.2" Steel Thickness to Comply with ASME PASE Requirements



Bearing Separators

5 Ton Bar-Type Puller/Bearing Separator Set
SKU 347218 27236 **99⁹⁹**

- Separator Tools are Used with Bar Puller and Legs for a Wide Variety of Pulling Jobs
- Set Includes: 2" and 3" Bearing Splitters, 4 Sets of Hex Push-Puller Legs and a Bar-Type Puller Head with a 9/16" Forcing Screw

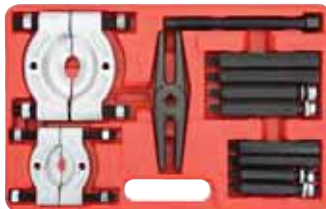

Bearing Splitter 1/4" to 15/16"
SKU 514005 27231 **29⁹⁹**

- Maximum Spread: 15/16"
- Minimum Spread: 1/4"
- Thread of Tapped Holes in Adapter: 5/16" to 18"
- Distance Between Adjusting Screws: 1-11/16"



Bearing Splitter 1/2" to 4-5/8"
SKU 514006 27232 **74⁹⁹**

Bearing Splitter 1/8" to 2"
SKU 516522 27084 **34⁹⁹**

Press Support

Universal Press Support
SKU 804487 24809 **199⁹⁹** REG. \$314.99

SAVE \$115

- Will Make Your Shop Press Safe and Easy to Use
- Supports in 3 Points to Ensure Safe Support without Any Wobbling
- Numerous Holes on Main Block and Swivel Element for Easy Set-Up
- Swivel Element and Removable/Height Adjustable Anvil Bolts Allow Adjustment to Individual Requirements
- Dimensions: 7-3/4" (W) x 9-3/4" (L) x 1-1/2" (H)



Offer Good While Supplies Last Through December 31, 2025

SHOP EQUIPMENT

Aqueous Parts Washers

- Works with Safe Water-Based Cleaning Solutions Only (Not for Use with Solvents)
- 325 GPH Pump
- Powder-Coated 20 Gauge Steel for Durability and Rust Resistance

Steel Parts Washers

3.5 Gallon Bench Top
SKU 300128
24800

SAVE \$45

99⁹⁹ REG. \$144.99
• Dimensions:
18" (L) x 13-1/2" (W) x 9" (H)



20 Gallon Mobile
SKU 750449
24805

SAVE \$70

329⁹⁹ REG. \$399.99
• 4" Casters for Maneuverability
• Drain Tray with 2.9 Gallon Collection Reservoir
• Dimensions:
38" (L) x 21.5" (W) x 37" (H)



20 Gallon
SKU 300117
24801

SAVE \$100

299⁹⁹ REG. \$399.99
• Small Parts Tray
• Dimensions:
31" (L) x 21" (W) x 34.5" (H)



40 Gallon
SKU 300118
24803

SAVE \$120

479⁹⁹ REG. \$599.99
• Small Parts Tray
• Dimensions:
44.75" (L) x 20.5" (W) x 35" (H)



Offers Good While Supplies Last Through December 31, 2025

4 Gallon Mobile Parts Washer
SKU 546660
24804

179⁹⁹ REG. \$249.99

SAVE \$70
• Lid Has Positive Seal and Latches for Mobility
• 4 GPM Pump
• Dimensions:
26" (L) x 18" (W) x 9.5" (H)



Offer Good Through December 31, 2025

Portable Bucket-Top Parts Washer
SKU 003759
24816

59⁹⁹

• Fits Most Standard 5 Gallon Buckets
• Includes: Submersible Pump, 40" Hose and Flow-Through Brush
• Pumping Rate: 1 GPM



OEM TOOLS

Pneumatic Heated Parts Washer Cabinet

SKU 1330681
24677

999⁹⁹

- Uses Compressed Air to Spray Heated Cleaner for Maximum Cleaning Effectiveness
- Fully Enclosed Chamber Keeps Cleaning Solution and Debris Contained
- Thermostat Controlled Heating Element Heats Cleaning Solution Up to 140°F (60°C)
- Fluorescent Lighting Inside Cabinet Illuminates Work Area
- Built-In Vent Fan Improves Visibility Inside Chamber While Cleaning
- Built-In Air Pressure Regulator and Gauge
- Adjustable Leveling Pads for Added Stability on Uneven Floors
- Holds Up to 3.5 Gallons of Cleaning Solution



Biological Parts Washers

Ocean Sunset 3.0 Pack
SKU OSB
SRIPAF0000623

3,349⁹⁹

- 26 Gal. Tank Capacity
- Environmentally Friendly and Solvent Free
- Soak Sink for Cleaning of Heavy Soiled Parts
- Multi-Stage Heater
- Sealed Lid
- Includes: (5) 5 Gallon Containers of Bluesolution and 4 Tablets



For OSB, Call 901-300-4878

Gravity X2 Mobile Pack
SKU OSB
SRIPAF0000717

2,199⁹⁹

- 10 Gal. Tank Capacity
- Heating Speed of 15 Minutes
- Regulated to 100°F
- Easy to Move Around
- Environmentally Friendly and Solvent Free
- Simple Controls
- Easy Maintenance
- Air or Electric
- Includes: (2) 5 Gallon Containers of Bluesolution and 4 Tablets



BlueTablets SRBT
SKU 1485037
SRIOFOMBT1100

89⁹⁹

- Simple Small Tablets
- Convenient
- Qty: 4 Tablets



BlueLiquid SRBLPE+ Aqueous Solution
SKU 1485035
SRIPFOL2P-100

159⁹⁹

- Designed for Industrial Cleaning
- Concentrated Cleaning Solution for Biological Parts Cleaning
- Water Based
- ECO friendly



Washer Accessories

Straight Handle Flow Thru Parts Washer Brush

SKU 1368637
BRMPWA

39⁹⁹

- Made with Synthetic Filaments to Resist Solvent Cleaners
- Works with Most Popular Recirculating Parts Washers
- For Use in Either Petroleum-Based or Water Based Solutions



Parts Washer Brush without Tube

SKU 1368624
BRMPWANT

34⁹⁹

Air Operated Sprayer

SKU 222507
LIN5983

84⁹⁹

- 1/4" NPT (F) Inlet
- Max. Operating Pressure: 150 psi
- Can Be Used with Solvents or Detergent Solutions



LINCOLN

Abrasive Blasting

Bench Top Abrasive Blast Cabinet
SKU 300119
24815

274⁹⁹ REG. \$369.99

- Easily Remove Paint, Rust and Oxidation
- Fits on the End of Any Bench or Cabinet
- Overall Height: 19.3"
- Exterior Width: 19.3"
- Work Area: 3.18 Cubic Ft.
- Includes: 10 Replaceable Window Underlays



OEM TOOLS

SAVE \$95

Offer Good While Supplies Last Through December 31, 2025

25 Lb. Glass Bead Blasting Media

- Ideal for Many Uses
- Removes Surface Rust
- Paint and Body Applications

Coarse
SKU 010136
SHA13077

189⁹⁹

Medium
SKU 010139
SHA13078

189⁹⁹

SHARK USA

Floor Scrubbers

Battery Powered
14" Floor Scrubber

SKU **OSB** **4,999⁹⁹**
IPCCT15

- Height-Adjustable Handle
- Removable Recovery Tank
- 1.5 Hour Run Time
- Includes: Lithium Battery, Charger and Brush



WARRANTY:
10 Years Tank
3 Years Parts
3 Years Battery

For OSB, Call 901-300-4878

Battery Powered 20" Floor Scrubber

SKU **OSB** **5,399⁹⁹**
IPCCT50

- 13 Gallon Tank Capacity
- 2.5 Hour Run Time
- For Up to 10 Bay Shop
- Includes: Self-Leveling Brush Head and Cast Aluminum Squeegee Assembly, 2 AGM Maintenance Free Batteries and Charger



WARRANTY:
10 Years Tank
3 Years Parts, 1 Year Battery

Cleaner/
Degreaser
1 Quart Bottle (6 Pack)

SKU **OSB** **99⁹⁹**
IPCT80451

- High Performance Concentrated Formula Quickly Cuts through Grease, Oil and Tough Carbon Soils



For OSB, Call 901-300-4878

Spray Wash Cabinets

- Heavy Duty Steel Construction
- Removable Parts Tree
- Brass Nozzles
- Heavy Duty Rubber Casters
- Stainless Oil Skimmer
- Removable Tank Screen



Inside Height 43"



Each Cabinet Includes:
20 Lb. Aluma-Klean Soap Bucket

VALUE:
\$149.99



Aluma-Klean
Soap Bucket
20 Lb.

SKU **751966**
RAN5155096
149⁹⁹

50 Lb.
SKU **1442593**
RAN5155100
349⁹⁹



Solvent-Free Cleaning Solution



Heavy Duty
Degreaser
Concentrate
(5 Gallons)

SKU **227558** **279⁹⁹**
WWSHD-5G

- Quickly Removes Grease, Oil, Carbon and Grime While Safe for the Technician



**Designed to Effectively
Replace Hazardous
Solvent in Water-Based
Parts Washers**

SKU	Part #	Product	Tank Capacity	Load Capacity	Price
1105323	RANRS500DS	Stainless Steel	50 Gallon	500 Lb. Load	12,449.99
1089035	RANRS750DS	Stainless Steel Truck	53 Gallon	1,000 Lb. Load	13,199.99
82919	RANRS500D	Professional	50 Gallon	500 Lb. Load	8,099.99
82920	RANRS750D	Truck	53 Gallon	1,000 Lb. Load	8,799.99



Customer Responsible for Offloading, Liftgate Service Available.

Vises

4-1/2" Light Duty Bench
Vise with Swivel Base

SKU **751645** **49⁹⁹**
24216

- Replaceable Steel Jaws
- Permanent Pipe Jaws
- Full 360° Swivel Base
- Jaw Width: 4-1/2"
- Jaw Opening: 4-1/2"
- Throat Depth: 1.75"



6" Heavy Duty
Bench Vise with Swivel Base

SKU **751654** **139⁹⁹**
24218

- Replaceable Steel Jaws
- Permanent Pipe Jaws
- Full 360° Swivel Base
- Jaw Width: 6"
- Jaw Opening: 6"
- Throat Depth: 2.6"



6-1/2" Professional
Workshop Vise

SKU **394648**
KTL64065

399⁹⁹

- Jaw Width: 6-1/2"
- Jaw Opening: 9" Replaceable, Reversible Jaws

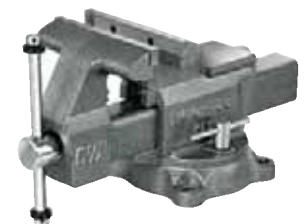

SHOP EQUIPMENT

Pipe Bender

BB-2 Pipe Bender with 302 Die Package

SKU 15341 **12,199⁹⁹**
BENBB2

- Knee Control and Depth-of-Bend Degree Plate for Manual Bending Operations
- Includes: BB-2 Tooling Package, Quick Release Bending and Finishing Dies, High-Speed Clampless Swager and Internal Expander

1302 Automatic with 302 Die Package

SKU 15346 **13,099⁹⁹**
BEN1302BAS302

Large 3" Die Package – Optional

SKU 95070 **1,649⁹⁹**
BEN300-1

- Optional Die Package Extends the Bending Capabilities of Your BendPak Pipe Bender



BendPak

Drill Press

15" 16 Speed Floor Drill Press

SKU 082857 **24992**
499⁹⁹

- Drilling Depth: 3-5/16"
- 16 Speed Spindle: 240 to 3,200 RPM
- Dimensions: 15" x 25-1/3" x 63-1/3"
- Distance from Spindle to Table: 27"
- Distance from Spindle to Base: 47"



Chuck Size: 5/8" JT3 Taper

Swings: 15"

OEM TOOLS

To Confirm Price, Availability and Ordering Instructions on OSB, Call 901-300-4878

Shop Vacuums

Air Blow and Suction Gun

SKU 1168663 **49⁹⁹**
26038 REG. \$74.99

- One-Touch Button That Changes the Gun from Blow to Suction
- Standard Shop Vacuum Power for Quick and Easy Clean Up
- Lightweight Gun
- High Filtration Collection Bag
- Rugged and Durable Metal Construction and Easy-to-Use Trigger
- 1/4" PT/NPT Inlet and 90 psi



Offer Good While Supplies Last Through December 31, 2025

OEM TOOLS

SAVE \$25

8 Gallon Wet/Dry Stainless Steel Vacuum

SKU 750618 **134⁹⁹**
BIG55035

- 120V
- 5.5 HP Peak Motor
- Includes: 5ft Hose, 3 Extension Hoses, 1 HEPA Filter, 1 Sponge Filter, Floor Brush, Sofa Brush, Crevice Tool and 1 Paper Dust Bag



BigVac

Headlight Aimers

Headlight Aiming System

SKU OSB **2,629⁹⁹**
SYMHBAS

- Certified in Maryland and Virginia
- Laser Floor Slope Measurement, Accurate, Precise and Easy to Achieve
- Photosensor Positioning



SYNTECH

Pressure Washers

Electric Pressure Washer

SKU OSB **5,399⁹⁹**
MTMCW3004SME1

- Pump Accepts Incoming Water Up to 165°F
- PSI: 3000 GPM 3.9
- Includes Quick Connect Nozzles – 0°, 15°, 25° and 40°, 50, 50' x 3/8" High Pressure Hose, Insulated Trigger Gun and Adjustable Pressure Insulated Dual Lance and 35' Power Cord
- 8.0 HP, 230V



WARRANTY: 1 Year Electric Motor and 7 Year General Pump

Wall Mount Electric Pressure Washer

SKU OSB **3,949⁹⁹**
MTMCAW20040ME1

- Pump Accepts Incoming Water Up to 165°F
- 2000 psi, 3.9 GPM
- 6.0 HP, 230V
- Includes: Quick Connect Nozzles – 0°, 15°, 25° and 40°, 50' x 3/8" Hose and 36" Adjustable Pressure Dual Lance



WARRANTY: 1 Year Electric Motor and 7 Year General Pump

Mi-T-M

Headlight Aiming System

SKU OSB **1,629⁹⁹**
SYMCAV3

- Approved for Regulated Inspection Programs in the United States except Virginia and Canada
- Laser Floor Slope Measurement: Accurate, Precise, and Easy to Achieve
- Floor Slope Adjustment Easily Attained by Rotation of Eccentric Wheel



Hot Water Pressure Washers

HSE 1400 psi Hot Water Pressure Washer
 SKU **OSB**
MTMHSE1400M11 **3,399⁹⁹**

- Diesel or Kerosene Fired Burner
- 1400 psi, 2.0 GPM
- 1.5 HP, 120V
- Includes: 50' x 3/8" Wire Braided Hose, Adjustable Pressure Insulated Dual Lance with 15° Fixed and Detergent Nozzle



WARRANTY:
 1 Year Electric Motor, 3 Years Coil and 7 Years Mi-T-M Pump

HSE 1500 psi Hot Water Pressure Washer
 SKU **OSB**
MTMHSE15020MM **4,349⁹⁹**

- Diesel or Kerosene Fired Burner
- Fuel Consumption: 1.2gph
- 1500 psi, 2.0 GPM
- Temperature Rise: 150°F (66°C); Max. Outlet Temperature: 200°F (93°C)
- Includes: Quick Connect Nozzles - 0°, 15°, 25° and 40°, 50' x 3/8" Wire Braided Hose and Adjustable Pressure Insulated Dual Lance



WARRANTY:
 1 Year Electric Motor, 3 Years Coil and 7 Years Mi-T-M Pump



Dual Fuel Powered Generator



5500-Watt Dual Fuel Portable Generator
 SKU **OSB**
CHM201505 **849⁹⁹**

- Dual Fuel: Runs on Gasoline or Propane, Providing Up to 11 Hours of Run Time on Gasoline or 6.5 Hours on Propane
- Monitors Voltage, Frequency and Run-Time Hours



WARRANTY:
 3 Years Limited

CARB Compliant

To Confirm Price, Availability and Ordering Instructions on OSB, Call 901-300-4878

SHOP OWNERS, WE LOAN SPECIALTY TOOLS FOR SPECIAL JOBS!

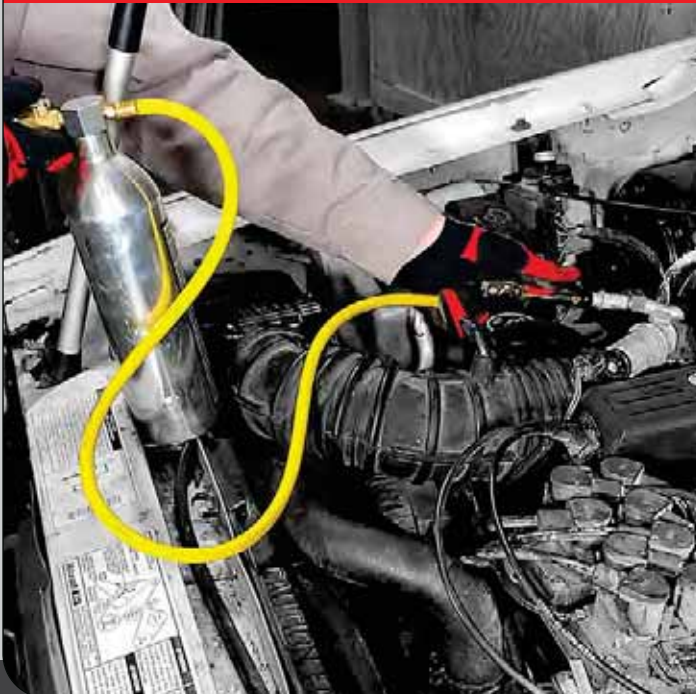

AUTOZONE® LOAN-A-TOOL® PROGRAM

Over 90 Specialty Tools for Loan or Sale

We offer the most complete selection of tools for a variety of jobs, from steering and suspension, air conditioning, engine repair and more.

The best part is Loan-A-Tool® products are free to use! Leave a deposit at the store when you pick up the tool. When you're through just bring it back within 90 days, and we'll refund the deposit, or keep the tool.



Ford Triton Spark Plug Porcelain Extractor Master Set



A/C Flush Kit



Fuel Injector Puller Kit - VW/Audi

See your Commercial Sales Manager for a complete list of loaner tools.

WELDING & CUTTING

Multi-Process

200A Multi MIG Synergic, TIG & Stick Welder (115-230VAC)

SKU OSB
HSAHSW-6420 **2,995⁹⁹**

- Welds MIG, DG TIG & Stick up to 3/8" Mild Steel
- 115V or 230V
- Inverter Rated 200A @ 35% DC
- 16 Program LCD Synergic Input
- Includes: Welder, MIG Gun, TIG Torch, Stick Cable, Earth Clamp Cable, Foot Pedal, 115V Adapter, Gas Regulator, Wire and TIG Kit
- Aluminum Spool Gun Ready (Not included)



3-in-1

Easy Weld 140 MP

SKU 1580962 **549⁹⁹**
FRN271

- 3-in-1 Machine (Stick/MIG/TIG, TIG Torch not Included)
- Input: 120V | Output Voltage: 12-23V | Output Current Range: 43-110A
- Duty Cycle: Stick 30% @ 80A, MIG 30% @ 90A and TIG 30% @ 110A
- Includes: 10' MIG Gun, 8' Electrode Holder, 8' Ground Clamp, 20A-15A Adaptor and One Additional .030 in Contact Tip
- No Gas Required



190 MP MIG Stick TIG Welder

SKU 1580957 **1,499⁹⁹**
FRN323

- 4-in-1 Multi-Process Machine (MIG/Stick/Flux-Core/DC TIG, TIG Torch Not Included)
- Amperage Range (MIG): 120V: 30A-120A | 240V: 30A-200A
- Amperage Range (Stick): 120V: 10A-80A | 240V: 10A-190A
- Amperage Range (TIG): 120V: 10A-85A | 240V: 10A-190A
- Includes: 6' Power Cable, 8' Stick Electrode Holder, 8' Ground Cable and Clamp, 120V-240V Adapter Cord, 6' Gas Hose, 10' MIG Gun, Gas Regulator, Spare .030" and .035" Tips



MIG Welder

MIG and Flux-Core Welder (130 Amp)

SKU OSB
HSAHSW-6213 **969⁹⁹**

- Features Wire Speed and Power Settings by Material/Wire Thickness
- Rated Duty Cycle: 20% @ 130 Amps
- Includes: Inverter, Power Supply, Torch, Earth Clamp, Gas Regulator, Spool of .030" FluxCore Wire and Spool of .030" MIG Wire



To Confirm Price, Availability and Ordering Instructions on OSB, Call 901-300-4878

Plasma Cutter

Flex 30™ Plasma and Stick/Tig Welder

SKU 1580950 **1,249⁹⁹**
FRN320

- Cut and Weld Up to 3/8" Thick Material with One Small, Powerful Machine
- Amperage Range (TIG): 120V: 10A-85A | 240V: 10A-160A
- Amperage Range (Stick): 120V: 10A-80A | 240V: 10A-160A
- Amperage Range (Plasma): 120V: 10A-20A | 240V: 10A-30A
- Includes: Forney Flex 30™ Plasma ST Machine, Additional Set of Consumables, 6' Power Cable, 8' Stick Electrode Holder, 8' Ground Cable and Clamp, 15' Plasma Torch and 120V-240V Adapter Cord (TIG Torch Not Included)



Welding Accessories

Multi-Purpose Welding Gloves

SKU 1544656 **29⁹⁹**
FRN53415

- Size: Men's Large
- Ultra-Soft Premium Goatskin Leather
- Back of the Hand is Lined for Extra Defense from Heat, Palm is Unlined for Dexterity and Finger Control



Welder Start-Up Kit

SKU 1544655 **69⁹⁹**
FRN377

- Bandit Flip Front Welding Helmet with Fully Adjustable Ratcheting Headgear
- Leather Welding Gloves
- Chipping Hammer with Anti-Shock Handle
- Carbon Steel Scratch Brush



Acetylene Torch

Medium Duty Torch Kit

SKU 1580955 **299⁹⁹**
FRN1705

- Cuts Up to 150 mm (5.91") and Welds Up to 9 mm (0.35") with Proper Tips
- Includes: 250-Series Regulators, 100-Series Torch Handle, 1350-Series Cutting Attachment, 0-3-101 Cutting Tip, W-1-0 Welding Tip, 1/4" (6.35 mm) X 12.5' (3.81 m) Twin Welding Hose with Fittings, #5 Goggles, Round Single Flint Striker, 13-Piece Tip Cleaner and Plastic Carry Case



Welding Cart

Portable Welding Cart

SKU 1544669 **169⁹⁹**
FRN332

- Steel Construction
- Dimensions: 11-1/2" (W) x 27-1/2" (H)
- Weight Capacity: 90 Lb. (40.8 Kg)
- Sleek Black Finish for a Professional Look



WELDING & CUTTING

TO ORDER, contact your Commercial Sales Manager or go to AutoZonePro.com

WELDING & CUTTING

Welding Helmets



Valor Auto-Darkening Welding Helmet

SKU 1544661 **119⁹⁹**
FRN55861

- 5.97 Sq. In. (3.62" x 1.65") Viewing Area
- 2 Optical Arc Sensors
- 1/1 1/2 Optical Clarity Rating
- UV/IR Coating to Reduce Scratching and Discoloration of the Lens
- DIN 9 to 13 Variable Shade Selection
- 1/25,000 Per Second Switching Speed



Auto Darkening Welding Helmet

SKU 362974 **69⁹⁹**
24357

- TIG Rated Variable Shade 9 to 13
- Viewing Area: 3.54" x 1.37"
- Battery Powered with Solar Assist
- Includes: Replacement Cover Lenses



Soldering

Mechanics Butane Mini Torch

SKU 804655 **24⁹⁹**
24353

- Adjustable Flame Lights Upside Down
- Auto Ignition, Refillable
- Safety Lock When Not in Use

Butane Not Included



Professional 3-in-1 Butane Soldering Iron Kit

SKU 420338 **49⁹⁹**
24355

- Includes: Soldering Iron, Metal Tip Wicking Cup with Sponge, Solder Wire, Protective Tip Cap, Heat-Shrink Deflector, Chisel Point Tip, Anvil Solder Tip, Needle Tip and Hot Air/Soldering Tip
- Cable Free



Mechanics Butane Torch

SKU 802236 **19⁹⁹**
24354

SAVE \$15

REG. \$34.99

- Heavy Duty Piezo Ignition with Strong Flame

Butane Not Included



Offer Good Through December 31, 2025



Auto Darkening Welding Helmet with Grinding Function

SKU 347233 **69⁹⁹**
24358 REG. \$109.99

- TIG Rated Variable Shade 9-13
- Variable Sensitivity and Delay Controls
- 2 Independent Arc Sensors
- Grinding Function
- Lens Darkening is 1/25,000
- Battery Powered with Solar Assist
- Includes: Replacement Cover Lenses
- Viewing Area: 3.62" x 1.65"

SAVE \$40



Offer Good Through December 31, 2025



Premium Welding Helmet - Gray Matter

SKU 1400038 **119⁹⁹**
JAS47102

- 6.24 Sq. Inch Viewing Area
- Auto Darkening Filter Meets 1/1/1/1 Optical Clarity Standard, the Highest in the Industry
- Powered By Solar Technology and (1) CR2032 Lithium Battery



Professional 3-in-1 Butane Micro Torch Kit

SKU 420339 **39⁹⁹**
24356 REG. \$54.99

- 3-in-1 Design Can Be Used as a Soldering Iron, Torch or Hot Air Blower without Iron Tip
- Micro Torch Kit Includes: Torch, Metal Tip Wicking Cup with Sponge, Heat-Shrink Deflector, Chisel Point Tip, Anvil Solder Tip, Needle Tip and Hot Air/Soldering Tip and Base
- Ideal for Use with Electrical Repair, Tin and Plastic Melting, Heat-Shrinkable Tubing, Auto Repair, Hobby Repair and Jewelry Repair
- Power Range: 30W to 125W

SAVE \$15



Butane Not Included

Offers Good While Supplies Last Through December 31, 2025

Professional Soldering Gun Kit

SKU 1362003 **49⁹⁹**
24773 REG. \$69.99

- Includes: Heavy Duty 230/150-Watt Soldering Gun, General Purpose Soldering Tip, Plastic Cutting Tip and 0.5 Oz. (14 g) Rosin Core Solder
- Reaches Max. Temperature of 937°F at Low Power
- Reaches Max. Temperature of 1400°F at High Power
- 120V, 150/230W, 60 Hz

SAVE \$20



Consumables

E71T-GS Flux-Core Welding Wire 0.030" 2 Lb.

SKU 1544675 **26⁹⁹**
FRN42300

- Tensile Strength: 79,000 psi
- Weight: 2 Lb.
- Recommended Polarity: DCEN Straight
- No Shielding Gas Required



ER70S-6 MIG Welding Wire 0.030" 10 Lb.

SKU 1544677 **59⁹⁹**
FRN42286

- Tensile Strength: 70,000 psi
- Weight: 10 Lb.
- Recommended Polarity: DCEP Reverse Polarity
- Required Shielding Gas: Argon/CO2



E71T-GS Flux-Core Welding Wire 0.035" 2 Lb.

SKU 1544668 **26⁹⁹**
FRN42302

- Tensile Strength: 79,000 psi
- Weight: 2 Lb.
- Recommended Polarity: DCEN Straight
- No Shielding Gas Required



Prices subject to change without notice. Prices do not include applicable taxes, vehicles, tires, rims, installation or optional equipment as shown. Please do not return purchases to the store. For information regarding warranty, repair, or any questions or concerns, call 901-300-4878.

AZG0425

129

PAINT & BODY

Dent Repair

Adjustable Bumper Stand

SKU **OSB** **234⁹⁹**
ATD6572

- Holds Any Plastic Bumper Cover without Touching the Painted Surface
- Cover Can Be Rotated 90° to Ensure Proper Paint Coverage
- 5 Locking Positions
- Protective Rubber Boots Keep Critical Areas Free of Overspray
- 4 Industrial Grade Casters with 2 Locking for Zero Movement

For OSB, Call 901-300-4878



ATD
AFTERMARKET TOOL DISTRIBUTION

Dent Puller

Slide Hammer Dent Puller Set

SKU **265148** **194⁹⁹**
25922

- 12 Lb. Hammer, Slide Hammer Shaft, Slide Hammer Handle, Slide Hammer Adapter, Deep Hook, Short Hook, Door Edge Tool, Claw, Straight Driver, Hook and Chain, Sheet Metal Screw and Holder, Nose Piece with Screw
- Comes in a Blow Mold Case



OEM TOOLS

Body Repair

Fast Action Body Repair Kit

- Includes: Hydraulic Pump, Hydraulic Ram, 4 Extension Rods, a Rubber Ball Foot and a Duckbill Hydraulic Spreader
- Features a Faster Double-Action Hydraulic Pump
- Includes: Blow Mold Case

4 Ton
SKU **301327** **179⁹⁹**
24820 REG. \$299.99

SAVE \$120

Offer Good Through December 31, 2025



OEM TOOLS

3 Piece Body Seam Splitter Set

SKU **265129** **49⁹⁹**
25337

- Includes: Straight, 30° Offset and 90° Angle Seam Splitters
- Tough Chrome Vanadium Steel
- GoThru® Shafts
- Shock Dampening Grip Provides Comfort



Windshield Tool

18" Professional Windshield Knife

SKU **480782** **29⁹⁹**
CAL53100

- Constructed of Heavy Duty Steel and Aluminum with a Padded Ergonomic Handle



Cal-Yan

Door Tools

Door Spring Tool

SKU **447118** **14⁹⁹**
25336

- Quickly and Easily Remove or Install Door Hinge Springs
- Designed for GM Cars and Light Trucks



OEM TOOLS

Panel and Trim Clip Pliers

SKU **447154** **29⁹⁹**
25930

- Designed to Remove Panel Clips
- Constructed with a Durable Chrome Plated Alloy Steel
- 2-Step Tip Minimizes Risk of Clip Damage
- Ergonomic Comfort Grip Handles for Reduced User Fatigue



Hood Props

Telescopic Hood Support

SKU **420337** **14⁹⁹**
24211

- Simple Turn Locks and Unlocks the Support in Place
- Rubber End Caps Protect Vehicle's Finish
- 21" When Closed and Almost 48" When Fully Extended
- Compact and Easy to Store, Easy to Use

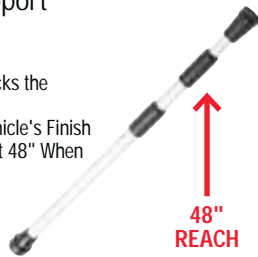

48" REACH

OEM TOOLS

Universal Lift Support Clamp

SKU **191671** **14⁹⁹**
25307

- Securely Holds Weak Lift Supports in the Extended Position to Allow Access to the Engine Compartment or Luggage Area



OEM TOOLS

Hood Prop with Adapter

SKU **291352** **79⁹⁹**
LIS46170

- Includes a Support to Help Prevent Slipping
- 3 Piece Telescoping Shaft Locks in Any Position (Telescopes from 20" to 48-1/4")



Lisle

5 Piece Door Panel and Trim Remover Set

SKU **989263** **44⁹⁹**
25312 REG. \$64.99

- Comprised of 3 Door Panels and 2 Trim Tools
- Textured, Comfortable Grips with Thumb Stop and Hanging Hole

Offer Good Through December 31, 2025



SAVE \$20

6 Piece Door Panel and Trim Removal Set

SKU **003868** **54⁹⁹**
25301

- Includes: V-Notch Clip Remover, U-Notch Clip Remover, 2 Door Panel Removal Tools, C-Type Clip Removal Tool and Handle Clip Removal Tool



Trim Tools

3 Piece Light Duty Smoothing/Prying Kit

SKU **004111** **9⁹⁹**
25084

- Pry Dashboard Parts and Vents without Damaging Interior
- Clean Crevices and Joints in Small Electronics
- Disassemble Key Fobs and Other Remotes
- Evenly Smooth Epoxy and Adhesives

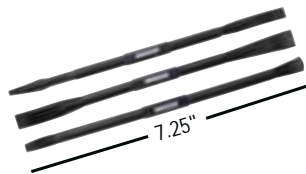

1.25"

Air Bag Release Tool for GM

SKU **191678** **14⁹⁹**
25310

- Fits Most GM Cars, Minivans and Light Trucks
- Tips are Tapered to Make Removal Easier



Trim Fastener and Molding Remover Set

SKU **900801** **14⁹⁹**
25314

- Includes: 5 Tools for Easy Removal of Fasteners, Molding, Wheel Hubs and More
- For Use on Internal and External Vehicle Molding and Trim Fasteners



OEM TOOLS

HAND TOOLS

TO ORDER, contact your Commercial Sales Manager or go to AutoZonePro.com

HAND TOOLS

Combo Wrench Sets

RingStop® Reversible Ratcheting Wrench Set

- Patented RingStop® Design Makes One-Hand Use Easy
- Posi-Grip No-Slip® Design
- Jaw is 15° Offset
- Made with Chrome Vanadium Steel



Go Thru Ratcheting Head



Flex Head Flare Nut Wrench Sets
5 Piece (SAE)
SKU 749849
22063



- 1/4" x 5/16", 3/8" x 7/16", 1/2" x 9/16", 5/8" x 11/16", 3/4" x 7/8"

8 Piece Set (SAE)
SKU 803139
23989

BONUS+SAVINGS
\$79

- REG. \$154.99
- SAE Sizes: 5/16", 3/8", 7/16", 1/2", 9/16", 5/8", 11/16" and 3/4"



10" Width x 7.8" Depth

12 Piece Set (Metric)
SKU 803140
23988

BONUS+SAVINGS
\$84

- REG. \$199.99
- Metric Sizes: 8, 9, 10, 11, 12, 13, 14, 15, 16, 17, 18 and 19 mm



15" Width x 10" Depth

BONUS VALUE: \$24.99

BONUS VALUE: \$34.99

8 Piece Go Thru Socket Set (SAE)
22979



With Purchase of 23989

Offers Good While Supplies Last Through December 31, 2025

12 Piece Go Thru Socket Set (Metric)
22978



With Purchase of 23988

Combo Wrench Sets

14 Piece (SAE)
SKU 802222
23993

SAVE \$100

- REG. \$219.99
- 1/4", 5/16", 3/8", 7/16", 1/2", 9/16", 5/8", 11/16", 3/4", 7/8", 15/16", 1", 1-1/16" and 1-1/8"

16 Piece (Metric)
SKU 802224
23994

SAVE \$70

- REG. \$189.99
- 6, 7, 8, 9, 10, 11, 12, 13, 14, 15, 16, 17, 18, 19, 21 and 22 mm



Offers Good Through December 31, 2025

6 Piece (Metric)
SKU 749930
22064

SAVE \$55

- REG. \$129.99
- 9 mm x 11 mm, 10 mm x 12 mm, 13 mm x 14 mm, 15 mm x 17 mm, 16 mm x 18 mm, 19 mm x 21 mm



10" Width x 7.8" Depth

Offer Good Through December 31, 2025

10 Piece Combination Wrench Set (Metric)
SKU 127920
22995

SAVE \$15

- REG. \$69.99
- Includes: 10 to 19 mm
- Posi-Grip No-Slip® Design Provides Off-Corner Loading for Greater Torque with More Socket-to-Fastener Contact
- Marked on All 4 Sides for Easy Identification



Offer Good Through December 31, 2025

JUMBO WRENCHES

Jumbo wrenches are made of high quality drop forged steel and are precision machined to prevent fastener damage.

Individual Jumbo Wrenches Available on AZTOOL1.COM

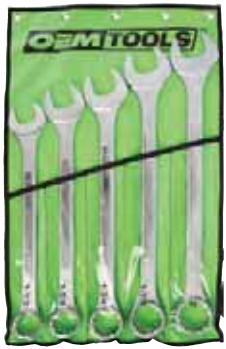

Sets Include Roll-Up Storage Bag

SKU	Part #	Metric or SAE	Size	Price
338830	22100	SAE	1-1/16", 1-1/8", 1-1/4", 1-5/16", 1-3/8" and 1-7/16"	134.99
338833	22101	SAE	1-1/2", 1-5/8", 1-3/4", 1-7/8" and 2"	194.99
338852	22120	Metric	21 mm, 22 mm, 24 mm, 25 mm, 27 mm, 29 mm, 30 mm and 32 mm	119.99
338858	22121	Metric	33 mm, 34 mm, 35 mm, 36 mm, 40 mm, 42 mm, 46 mm, 50 mm	224.99

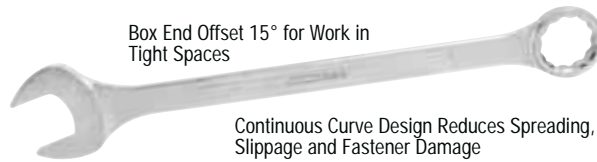

Box End Offset 15° for Work in Tight Spaces

Continuous Curve Design Reduces Spreading, Slippage and Fastener Damage

SKU	Part #	SAE Size	Price
338859	22102	1-1/16"	14.99
338864	22103	1-1/8"	19.99
338866	22104	1-1/4"	19.99
338868	22105	1-5/16"	19.99
338877	22106	1-3/8"	19.99
338890	22107	1-7/16"	19.99
338896	22108	1-1/2"	19.99
338898	22109	1-5/8"	24.99
338903	22110	1-3/4"	39.99
338935	22111	1-7/8"	44.99



Jumbo Angle Wrench Set

6 Piece Jumbo Angle Head Wrench Set
SKU OSB
22113



- Sizes: 1-3/8", 1-1/2", 1-5/8", 1-3/4", 1-7/8" and 2"



Includes Roll-Up Storage Bag

For OSB, Call 901-300-4878



Ratcheting Combination Wrenches

16 Piece 12 Pt. Ratcheting Combination Wrench Set (Metric)
SKU 213125
KDT9416



- Includes: 8, 9, 10, 11, 12, 13, 14, 15, 16, 17, 18, 19, 20, 21, 22 and 24 mm
- Ratcheting Box End Requires Only 5° to Move Fasteners
- 12 Point Design Providing More Positions to Engage the Fastener

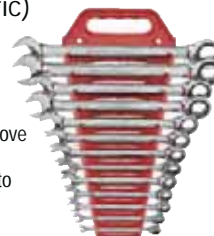

Wrench Extender

Wrench Extender
SKU 1368628
22656



- Safely Provides Extra Leverage to Loosen Rusted Bolts, Jammed Fasteners or Over-Tightened Nuts
- Great for Use on Those Hard to Reach Fasteners



Prices subject to change without notice. Prices do not include applicable taxes, vehicles, tires, rims, installation or optional equipment as shown. Please do not return purchases to the store. For information regarding warranty, repair, or any questions or concerns, call 901-300-4878.

HAND TOOLS

Screwdrivers

19 Piece Screwdriver Set

SKU 1142325 **59⁹⁹**
73775



- Slotted: 3/32" x 1.5", 1/8" x 2.5", 3/16" x 4", 3/16" x 8" (Cabinet Tip), 1/4" x 1.5" (Stubby), 1/4" x 4", 1/4" x 6", 5/16" x 6", 3/8" x 8"
- Phillips: #0 x 1.5", #0 x 2.5", #1 x 3", #2 x 1.5" (Stubby), #2 x 4", #2 x 8", #3 x 6", #4 x 8"
- Offset: 3/16" x #1, 1/4" x #2
- Magnetic Tips Hold Fasteners in Place
- Square Shafts Can Be Used with Wrench for More Torque
- Hexagon Shaped Handles Prevent Roll Off
- Color Coded Fluting Defines Driver Type



Impact Resistant Acetate Handle
(Fluted for Better Grip)



Ratcheting Screwdriver

Pivot-Grip Ratcheting Screwdriver

SKU 004103 **21⁹⁹**
22557



- Pivoting Handle Provides Ergonomic Gripping Positions
- Forward and Reverse Ratcheting
- Magnetic Bit Shaft for a Secure Fit
- Overall Length: 10"
- Internal Bit Cartridge for Convenient Storage
- Includes: 6 Bits: Phillips (#1, #2), Slotted (4 mm, 6 mm) and Robinson (#1, #2)



Internal Bit Storage Pivoting Handle Rotates from Straight-Grip to Pistol-Grip

Long Reach Screwdrivers

- High Performance Hex Shaped Shaft for More Torque and Less Flex
- Precision Machined and Sand Blasted Tips That Reduce Cam-Out
- Durable Ergonomic Handles are Made of Hardened Resin

5/16" x 20" Slotted Screwdriver

SKU 1142473 **24⁹⁹**
22555



#2 x 20" Phillips Screwdriver

SKU 1142485 **14⁹⁹**
22574

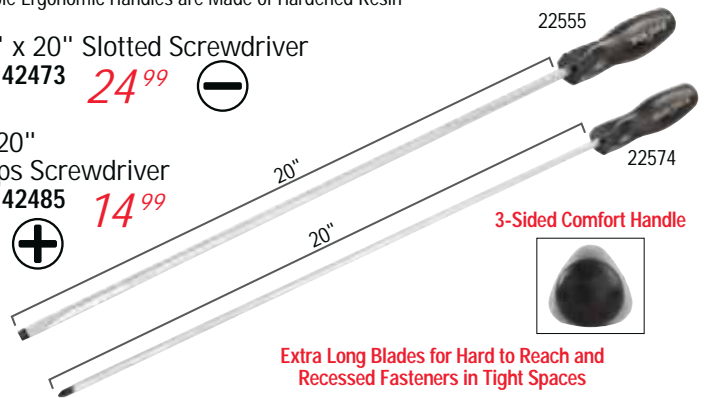

Extra Long Blades for Hard to Reach and Recessed Fasteners in Tight Spaces

8 Piece Mechanics Screwdriver Set

SKU 802208 **69⁹⁹**
23999 REG. \$99.99

SAVE \$30



- EVA Tray with Custom Cut Contrast Soft Foam and Sizes Marked for Easy Identification, Designed to Fit Securely in a Cabinet or Tool Box
- Features a Hard Chrome™ Finish, an Easy-to-Clean Smooth Satin Finish That Won't Show Prints and Keeps Rust Away
- Custom Cut of the Tool is a Hi-Vis Green Making it Visible if a Tool is Missing
- Slotted: 1/4" x 1-1/2", 3/16" x 3", 1/4" x 4", 5/16" x 6" and 3/8" x 8"



Offer Good Through December 31, 2025

20 Piece Screwdriver Set

SKU 1142343 **19⁹⁹**
92080



- Chrome Vanadium Steel Shaft for Strength and Durability
- Precision Ground Sandblasted Tip
- Highest Quality Acetate Handle
- Slotted: 3/32" x 2", 1/8" x 2", 3/16" x 4", 1/4" x 1-1/2", 1/4" x 4", 1/4" x 6"
- Phillips: #00 x 1-1/2", #0 x 2", #1 x 3", #2 x 4", #2 x 6", #2 x 1-1/2"
- Star: T15, T20
- Square: #2
- (1) Offset Screwdriver
- 4 Piece Hook and Pick Set



Star Screwdrivers

5 Piece Star Screwdriver Set

SKU 1142630 **14⁹⁹**
73721



- Star (T10 x 4", T15 x 4", T20 x 4", T25 x 5", T30 x 6")
- Magnetic Tips Hold Fasteners in Place
- Hexagon Shaped Handles Prevent Roll Off



Gasket Scraper Set

3 Piece Gasket Scraper Set

SKU 1069069 **24⁹⁹**
26501

- Includes: 3/4", 1" and 1-1/2" Gasket Scrapers



Hex Key Sets

27 Piece Star and Hex Key Set (Metric and SAE)

SKU 1209375 **69⁹⁹**
24299

- Extra Long Arm for Accessing Hard-to-Reach Spots
- Each Tool is Color Coded and Marked with Sizes for Easy Identification
- SAE and Metric Hex Keys Have Ball-End Design for Reaching at Angles Up to 25°



S2
STEEL



- Manganese Phosphate Finish Resists Corrosion
- 25° Entry Angle for Better Work Near Obstructions
- Long Arms Provide for Increased Torque and Extra Reach

35 Piece SAE, Metric and Star

SKU 1168819 **24⁹⁹**
24249



26 Piece SAE and Metric

SKU 1168833 **19⁹⁹**
24248

S2
STEEL



9 Piece Magnetic Long Arm Hex Key Set Long - SAE

SKU 978109 **24⁹⁹**
24261

- Includes: SAE Sizes: 1/16", 5/64", 3/32", 1/8", 5/32", 3/16", 1/4", 5/16" and 3/8" Color Coded Red - SAE Magnetic Tips Hold Fasteners in Place and Prevents Them from Slipping



HAND TOOLS

TO ORDER, contact your Commercial Sales Manager or go to AutoZonePro.com

HAND TOOLS

Mechanics Set

64 Piece 1/4" Drive Metric Set
SKU 020788 23997 **99⁹⁹** REG. \$139.99

SAVE \$40

OEM TOOLS

- Shallow Sockets, 6 Pt: 4 to 15 mm
- Deep Sockets, 6 Pt: 4 to 15 mm
- Drive Wobble Straight Extension
- Bit Extension Bars: 6" and 10"
- Ratchet Screwdriver
- Universal Joint
- Ratchet
- 28 Bits



Offer Good Through December 31, 2025

20" Width x 8" Depth

Ratchet and Socket Set

OEM TOOLS

26 Piece 1/2" Drive Ratchet and Socket Set
SKU 591154 23995 **99⁹⁹** REG. \$144.99

SAVE \$45

- Includes: (21) 6 Pt. Metric and SAE Sockets, (1) 1/2" Dr. Extension Bar 3", (1) 1/2" Dr. Extension Bar L6, (1) 1/2" Swivel U-Joint, and (1) 1/2" Dr. Regular Ratchet

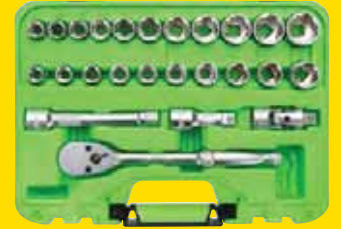

Offer Good While Supplies Last Through December 31, 2025

Universal Joints

OEM TOOLS

1/4" Drive
SKU 081225 22520 **9⁹⁹**



(Style May Vary)

1/2" Drive
SKU 081227 22522 **11⁹⁹**

3/8" Drive
SKU 081226 22521 **10⁹⁹**

Socket Adapters

3 Piece Low-Profile Adapter Set
SKU 818570 22535 **29⁹⁹**



- CR-V Steel for Strength
- Get into Tighter Spaces
- Includes: 1/4" F x 3/8" M, 3/8" F x 1/2" M, and 1/2" F x 3/4" M

Adapters

- Hard Chrome™ Finish is Easy to Clean and Will Keep Away Rust



22534

HARD CHROME™ FINISH **OEM TOOLS**

SKU	Part #	Drive	Price
81228	22530	1/2" F x 3/4" M	14.99
81229	22531	1/2" F x 3/8" M	10.99
81230	22532	3/8" F x 1/2" M	7.99
81232	22533	3/8" F x 1/4" M	6.99
81233	22534	1/4" F x 3/8" M	7.99

Socket Sets

- Posi-Grip No-Slip®
- Off Corner Loading for Greater Torque
- Knurling Position for Best Finger Gripping

- Chamfered Ends Allow the Socket to Easily Slip Over the Bolt Head
- Deep Marking for Easy Identification



1/4" Drive Socket Sets

10 Piece (SAE)
SKU 127786 22952 **19⁹⁹**
• 3/16" to 9/16"

12 Piece (Metric)
SKU 127836 22950 **19⁹⁹**
• 5 mm to 15 mm

10 Piece Deep (SAE)
SKU 1414402 22953A **26⁹⁹**
• 3/16" to 9/16"

12 Piece Deep (Metric)
SKU 127772 22951 **29⁹⁹**
• 5 to 15 mm



10 Piece 1/4" Deep (SAE)
SKU 850056 23985 **34⁹⁹**

OEM TOOLS

- Includes: 3/16" to 9/16"

12 Piece 1/4" Deep (Metric)
SKU 850510 23986 **34⁹⁹**

- Includes: 5 mm to 15 mm



10" Width x 4" Depth

3/8" Drive Socket Sets

11 Piece (SAE)
SKU 127798 22956 **29⁹⁹**
• 1/4" to 7/8"

12 Piece (Metric)
SKU 127794 22954 **35⁹⁹**
• 8 mm to 19 mm

11 Piece Deep (SAE)
SKU 127803 22957 **39⁹⁹**
• 1/4" to 7/8"

12 Piece Deep (Metric)
SKU 127797 22955 **40⁹⁹**
• 8 mm to 19 mm



12 Piece 3/8" Deep Socket Set (Metric)

SKU 103402 23981 **34⁹⁹** REG. \$59.99

- Includes: 8 mm to 19 mm

SAVE \$25



10" Width x 7" Depth



1/2" Drive Socket Sets

11 Piece (SAE)
SKU 127812 22960 **44⁹⁹**
• 1/2" to 1-1/8"

10 Piece (Metric)
SKU 127807 22958 **29⁹⁹**
• 10 mm to 19 mm

11 Piece Deep (SAE)
SKU 127846 22961 **45⁹⁹**
• 1/2" to 1-1/8"

10 Piece Deep (Metric)
SKU 127809 22959 **44⁹⁹**
• 10 mm to 19 mm



24 Piece 3/8" Drive Socket Set (Metric)

SKU 127868 22963 **49⁹⁹** REG. \$69.99

- Includes: 8-19 mm (Deep) and 8-19 mm (Shallow)

SAVE \$20

22 Piece 3/8" Drive Socket Set (SAE)

SKU 127869 22962 **44⁹⁹** REG. \$64.99

- Includes: 1/4" to 7/8" (Deep); 1/4" to 7/8" (Shallow)

SAVE \$20



Offers Good Through December 31, 2025

Prices subject to change without notice. Prices do not include applicable taxes, vehicles, tires, rims, installation or optional equipment as shown. Please do not return purchases to the store. For information regarding warranty, repair, or any questions or concerns, call 901-300-4878.

HAND TOOLS

Ratchets

- 36 Teeth with 10° Arc Motion for Precision and Strength
- Reversing Lever Allows a Forward and Reverse in One-Hand Action
- Sealed to Keep Dirt and Debris Out of Head
- Compact Head Designed to Get into Tight Spaces

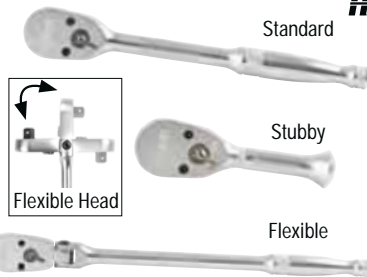

HARD CHROME™ FINISH OEM TOOLS®

SKU	Part #	Type	Drive	Length	Price
081298	22900	Standard	1/4"	4-1/4"	19.99
177728	22911	Standard	3/8"	8"	29.99
177768	22920	Standard	1/2"	10"	39.99
177702	22910	Stubby	3/8"	4"	29.99
081301	22901	Flexible	1/4"	6"	29.99
177730	22912	Flexible	3/8"	11-1/2"	39.99
177769	22921	Flexible	1/2"	17-1/2"	59.99

Extensions

OEM TOOLS®

- Chamfered Ends for Positive Engagement with Drive Tools
- Knurled Shank for Easy Fingertip Turning
- Milled Ends Provide a Solid Connection

SKU	Part #	Drive	Length	Price
081213	22481	1/4"	4"	5.99
081215	22482	1/4"	6"	7.99
081218	22483	1/4"	11"	4.99
081219	22490	3/8"	1-3/4"	9.99
081220	22491	3/8"	4"	10.99
306326	22492	3/8"	6"	8.99
306287	22494	3/8"	10"	11.99
081212	22480	1/2"	2"	3.99
081221	22500	1/2"	3"	4.99
081223	22501	1/2"	6"	11.99
081224	22502	1/2"	10"	14.99

Flex Head Breaker Bars

- Special Alloy Steel, Heat-Treated to Provide Durability
- 180° Flex Head Provides Leverage at Desired Angle for Hard-to-Reach Applications

SKU	Part #	Drive	Length	Price
081302	22913	3/8"	11-9/16"	24.99
081303	22922	1/2"	18"	34.99
750437	22923	1/2"	24"	39.99



Impact Driver

1/2" Drive Impact Driver Set
SKU 1142387 22561 **27⁹⁹**

- Easily Break Free Rusted, Corroded and Frozen Screws
- Includes: Impact Driver, Bit Adapter, 8 Impact Bits and Sturdy Blow Mold Case



Spiral Drive Set

5 Piece Spiral Drive Bit Set
SKU 802234 22975 **29⁹⁹**

- Sizes: MTS0, MTS1, MTS2, MTS3 and MTS4
- 3/8" Drive

- Services New Fasteners Found on Many GM, Chrysler, BMW and Fiat Vehicles of the Mid-2000 and Later Model Range Including Bolts That Secure the Bell Housing to the Transmission on GM 4L60 Transmissions



Triple Square Bit Sets

- Use on European Vehicles Like BMW, Mercedes, VW, Audi and Porsche
- Heat-Treated Alloy Steel Bits to Reduce Premature Wear
- Reinforced Chrome Vanadium Steel Sockets to Increase Turning Power

- Fully Refined Hard Chrome Plated Finish and Zinc Phosphate Bits Treatment to Prevent Rust and Corrosion
- Meets and Exceeds ANSI Standards

OEM TOOLS®

10 Piece Extra Long XZN Triple Square Spline Bit Socket Set

SKU 1368626 23519 **44⁹⁹** REG. \$49.99

- Sizes Included: M4, M5, M6, M8, M9, M10, M12, (Tamper-Proof) M14, M16, M18
- Socket Length: 3.93"



Offer Good Through December 31, 2025

10 Piece Magnetic Long Triple Square Bit Socket Set

SKU 1313567 23907 **54⁹⁹**

- Sizes Included: (1/4" Drive) M4, M5, M6; (3/8" Drive) M8, M9, M10, M12, M14; (1/2" Drive) M16, M18
- Socket Length: 3.93"



9 Piece Triple Square Bit Set

SKU 191052 25953 **29⁹⁹**

- 1/4" Drive: M4, M5 and M6 (Length: 37 mm)
- 3/8" Drive: M8, M10 and M12 (Length: 48 mm)
- 1/2" Drive Tamper-Proof: M14, M16 and M18 (Length: 55 mm)



10 Piece Triple Square Bit Socket Set

SKU 1368630 22711 **19⁹⁹** REG. \$29.99

- Sizes Included: M4, M5, M6, M8, M9, M10, M12, (Tamper-Proof) M14, M16, M18
- Comes Enclosed in Blow Mold Case for Easy Identification and Storage

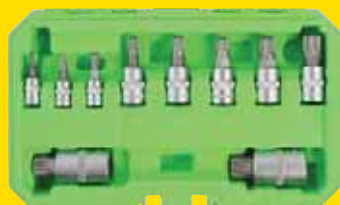

Offer Good Through December 31, 2025

10 Piece Magnetic Triple Square Bit Socket Set

SKU 1368615 23906 **44⁹⁹**

- Powerful Magnetic Bits to Prevent the Loss of Nuts, Bolts and Fasteners
- Comes Enclosed in Blow Mold Case for Easy Identification and Storage
- Sizes Included: (1/4" Drive) M4, M5, M6; (3/8" Drive) M8, M9, M10, M12, M14; (1/2" Drive) M16, M18



- Constructed for Professionals with Superior Materials for Increased Torque and Hardness
- Heat-Treated S2 Steel Bits to Reduce Premature Wear

- Reinforced Chrome Vanadium Steel Sockets for Durability and Improved Finish
- Fully Refined Hard Chrome Plated Finish and Zinc Phosphate Bits Treated to Prevent Rust and Corrosion



Hex Sets

12 Piece Magnetic (SAE)

SKU 1282759
23900 **34⁹⁹** REG. \$39.99

- 1/4" Drive: 1/16", 5/64", 3/32", 7/64" and 1/8"
- 3/8" Drive: 9/64", 5/32", 3/16", 7/32", 1/4", 5/16" and 3/8"

SAVE \$5

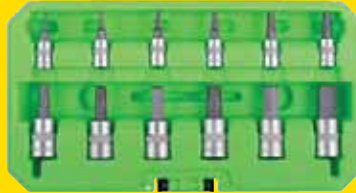

12 Piece Magnetic (Metric)

SKU 1282804
23901 **34⁹⁹** REG. \$39.99

- 1/4" Drive: 2 mm, 2.5 mm, 3 mm, 4 mm, 5 mm and 5.5 mm
- 3/8" Drive: 6 mm, 7 mm, 8 mm, 9 mm, 10 mm and 12 mm

12 Piece Magnetic Long (SAE)

SKU 1282807
23902 **44⁹⁹** REG. \$49.99

- 1/4" Drive: 1/16", 5/64", 3/32", 7/64", 1/8"
- 3/8" Drive: 9/64", 5/32", 3/16", 7/32", 1/4", 5/16" and 3/8"

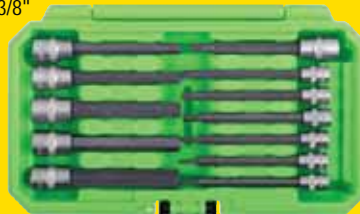

12 Piece Magnetic Long (Metric)

SKU 1282737
23903 **44⁹⁹** REG. \$49.99

- 1/4" Drive: 2 mm, 2.5 mm, 3 mm, 4 mm and 5 mm
- 3/8" Drive: 5.5 mm, 6 mm, 7 mm, 8 mm, 9 mm, 10 mm and 12 mm

Offers Good While Supplies Last Through December 31, 2025

26 Piece Master Hex Bit Set

SKU 802219
23990 **49⁹⁹** REG. \$69.99

- Includes: 1/4" Drive Sizes: 1/8" to 7/32" and 2.5 to 5 mm, 3/8" Drive Sizes: 1/4" to 11/32" and 6 to 9 mm, 1/2" Drive Sizes: 3/8" to 5/8" and 10 to 19 mm

SAVE \$20



Offer Good While Supplies Last Through December 31, 2025

12 Piece Long (SAE)

SKU 1282747
23563 **34⁹⁹** REG. \$49.99

- 1/4" Drive: 1/16", 5/64", 3/32", 7/64" and 1/8"
- 3/8" Drive: 9/64", 5/32", 3/16", 7/32", 1/4", 5/16" and 3/8"

SAVE \$15



12 Piece Long (Metric)

SKU 1282757
23538 **34⁹⁹** REG. \$44.99

- 1/4" Drive: 2 mm, 2.5 mm, 3 mm, 4 mm and 5 mm
- 3/8" Drive: 5.5 mm, 6 mm, 7 mm, 8 mm, 9 mm, 10 mm and 12 mm

SAVE \$10

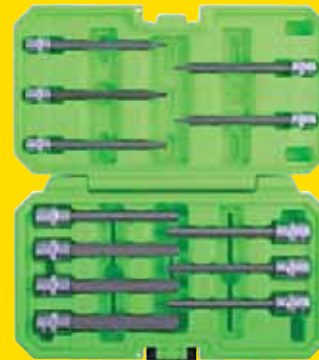

32 Piece Hex Bit Socket Set (SAE and Metric)

SKU 1282740
22989 **29⁹⁹** REG. \$49.99

- SAE
- 1/4" Drive: 1/8", 5/32", 3/16", 7/32" and 1/4"
 - 3/8" Drive: 9/32", 5/16", 3/8", 7/16" and 1/2"
 - 1/2" Drive: 9/16", 5/8", 11/16" and 3/4"
- Metric
- 1/4" Drive: 2, 2.5, 3, 4, 5, 5.5 and 6 mm
 - 3/8" Drive: 7, 8, 9, 10 and 12 mm
 - 1/2" Drive: 14, 15, 17 and 19 mm

SAVE \$20



Offers Good Through December 31, 2025

1/2" Drive Hex Bit Set (Metric)

SKU OSB
25417 **9⁹⁹**

- Sizes: 12, 14 and 17 mm
- Use on Transmission and Differential Drain Plugs



For OSB, Call
901-300-4878

7 Piece Hex Bit Set (SAE)

SKU 127904
22982 **29⁹⁹**

- 3/8" Drive: 5/16" and 3/8"
- 1/2" Drive: 7/16", 1/2", 9/16", 5/8" and 3/4"



1/2" Drive Metric Hex Bit Socket Set (7 Piece)

SKU 1168830
22998 **34⁹⁹**

- Includes: 13, 14, 15, 17, 19, 21 and 22 mm



9 Piece Hex Bit Set (Metric)

SKU 127903
22983 **19⁹⁹**

- Includes: 1/4" Drive 2, 2.5, 3, 4 mm and 3/8" Drive 5, 6, 7, 8, 10 mm
- Knurling Position is Optimized for Best Finger Gripping Position



1/2" Drive SAE Hex Bit Socket Set (6 Piece)

SKU 1168826
22999 **34⁹⁹**

- Includes 9/16", 5/8", 11/16", 3/4", 13/16" and 7/8"
- Tempered Chrome Vanadium Steel with a Plated Finish for Long Life



12 Piece Hex Bit Set (SAE)

SKU 127905
22984 **24⁹⁹**

- Includes: (1/4" Drive) 1/16", 5/64", 3/32", 7/64", 1/8"; (3/8" Drive) 9/64", 5/32", 3/16", 7/32", 1/4", 5/16", 3/8"
- Knurling Position is Optimized for Best Finger Gripping Position



HAND TOOLS

Multi-Drive Sets

35 Piece Multi-Drive Star Socket Set
SKU 802217 **69⁹⁹**
23991

- 1/4" Drive Star: T10, T15, T20, T25, T27 and T30
- 1/4" Drive Tamper-Proof Star: T7, T8, T9, T10, T15, T20, T25 and T30
- 1/4" Drive Female Star: E4, E5, E6, E7 and E8
- 3/8" Drive Tamper-Proof Star: T40, T45, T50 and T55
- 3/8" Drive Star: T40, T45, T47, T50 and T55
- 3/8" Drive Female Star: E10, E12, E14 and E16
- 1/2" Drive Star: T60 and T70
- 1/2" Drive Female Star: E18



10-3/4" Width x 5-3/4" Depth

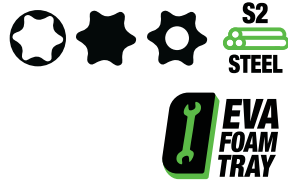

44 Piece Multi-Drive Star and Bit Socket Set
SKU 802206 **59⁹⁹**
23992

- 1/4" Bit Holder
- 1/4" Hex Drive Tamper-Proof Star Bits: T7, T8, T9, T10, T15, T20, T25, T27, T30
- 1/4" Hex Drive Star: T10, T15, T20, T25, T27 and T30
- 3/8" Drive Star: T40, T45, T47, T50, T55 and T60
- 3/8" Drive Metric Hex: 2, 2.5, 3, 4, 5, 6, 7, 8 and 10 mm
- 3/8" Drive SAE Hex: 1/8", 5/32", 3/16", 7/32", 1/4", 5/16" and 3/8"
- 3/8" Drive Phillips: #1, #2 and #3
- 3/8" Drive Slotted: 3/16", 1/4" and 5/16"



10-3/4" Width x 5-3/4" Depth

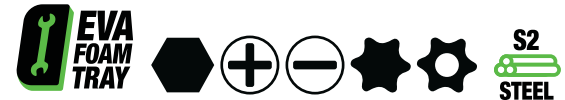

Star Sets

13 Piece Tamper-Proof
SKU 1282735 **29⁹⁹**
22710

- 1/4" Drive: T8, T10, T15, T20, T25, T27 and T30
- 3/8" Drive: T40, T45, T47, T50 and T55
- 1/2" Drive: T60



13 Piece Star Bit
Socket Set
SKU 1282806 **24⁹⁹**
22977

- 1/4" Drive: T8, T10, T15, T20, T25, T27 and T30
- 3/8" Drive: T40, T45, T47, T50 and T55
- 1/2" Drive: T60



35 Piece Master Star Bit Set
SKU 466622 **59⁹⁹**
25951

- 1/4" Drive Star: T8 to T30
- 1/4" Drive Tamper-Proof Star: T7, T8, T9, T10, T15, T20, T25 and T30
- 1/4" Drive Female Star: E4, E5, E6, E7 and E8
- 3/8" Drive Star: T40, T45, T47, T50 and T55
- 3/8" Drive Tamper-Proof Star: T40, T45, T50 and T55
- 3/8" Drive Female Star: E10, E12, E14 and E16
- 1/2" Drive Star: T60



13 Piece Magnetic
SKU 1267957 **39⁹⁹**
23904

- 1/4" Drive: T8, T10, T15, T20, T25, T27 and T30
- 3/8" Drive: T40, T45, T47, T50, T55 and T60



13 Piece Magnetic Long
SKU OSB **44⁹⁹**
23905 REG. \$49.99

- 1/4" Drive: T8, T10, T15, T20, T25, T27 and T30
- 3/8" Drive: T40, T45, T47, T50, T55 and T60



For OSB, Call
901-300-4878

Offers Good While Supplies Last Through December 31, 2025

OEM TOOLS

13 Piece
Extra Long
SKU 1282758 **49⁹⁹**
23680 REG. \$59.99

- 1/4" Drive: T8, T10, T15, T20, T25, T27 and T30
- 3/8" Drive: T40, T45, T47, T50, T55 and T60

SAVE \$10



Ratchet Not Included

11 Piece Tamper-Proof Star Set
SKU 127872 **29⁹⁹**
22972

- Includes: (1/4" Drive) T8, T10, T15, T20, T25, (3/8" Drive) T27, T30, T40, T45, T47, T50
- Knurling Position is Optimized for Best Finger Gripping Position
- Black Oxide Finish Indicates Star Drivers



Stubby Star Drive Sets

13 Piece
SKU 447157 **39⁹⁹**
24293

- 1/4" Drive: T7, T8, T9, T10, T15, T20, T25, T27, T30, T40, T45, T47 and T50



12 Piece Tamper-Proof Star Set
SKU 127870 **29⁹⁹**
22971

- Includes: (1/4" Drive) T8 to T25; and (3/8" Drive) T27 to T55
- Knurling Position is Optimized for Best Finger Gripping Position -- Go Ahead and Put On Serious Torque, it Won't Slip
- Black Oxide Finish Indicates Star Drivers
- Chamfered Ends Allow the Socket to Easily Slip Over the Bolt Head
- Makes Fastener Engagement Quick and Smooth



13 Piece Tamper-Proof
SKU 447156 **34⁹⁹**
24294

- 1/4" Drive: T7H, T8H, T9H, T10H, T15H, T20H, T25H, T27H, T30H, T40H, T45H, T47H and T50H



HAND TOOLS

TO ORDER, contact your Commercial Sales Manager or go to AutoZonePro.com

HAND TOOLS

Pro Series Pliers Sets

OEM TOOLS®

3 Piece Groove Joint Pliers Set

SKU 662761 **49⁹⁹**
22648

- Sizes: 8", 10" and 12"
- Gripping Capacity: 8" (1.25") 10" (1.80") 12" (2.25")



3 Piece Mechanics Pliers Set

SKU 662748 **44⁹⁹**
22647

- Pliers and Sizes: 7" Diagonal Pliers 8" Linesman Pliers 10" Speed-Fit Pliers



Locking Pliers

OEM TOOLS®

- For Clamping and Gripping in Tight Spaces
- Constructed with Heat-Treated Alloy Steel
- Precision-Machined Jaws Feature Hardened Teeth to Provide a Sure Grip from Any Angle
- Instant Locking and Release Mechanism for Improved Control
- Nickel Chrome Plated to Resist Rust

7 Piece Locking Pliers Set

SKU 012622 **144⁹⁹**
23987

- Sizes: 4", 5", 7", 10" Curved Jaw and 4", 6", 9" Long Nose



15" Width x 10" Depth



23987

Curved Jaw



22635

Long Nose



22637

Chain



22642

C-Clamp



22641

SKU	Part #	Type	Size	Price
081256	22635	Curved Jaw	4"	9.99
081257	22636		5"	14.99
081261	22638		7"	14.99
081263	22640		10"	19.99
081260	22637	Long Nose	6-1/2"	9.99
081262	22639		9"	14.99
081267	22642	Chain	19"	24.99
081265	22641	C-Clamp	11"	24.99

Extended Reach Pliers

OEM TOOLS®

16" Long Reach Long Nose Pliers Set - 3 Piece Set

SKU 1142915 **39⁹⁹**
22660

- Includes: Straight, 45° and 90° Long Nose Pliers
- Features Strong Flush Rivets That Won't Get Caught When Working in Tight Spaces
- Constructed with Heat-Treated Drop-Forged Steel Chrome Plated to Resist Rust and Corrosion
- Double Dipped Handles for Added Comfort and Secure Grip



11" Long Reach Long Nose Pliers

OEM TOOLS®

- Constructed with Durable Heat-Treated Alloy Steel
- Precision-Machined Jaws Provide Improved Grip
- TecReady Grip Handles Reduce User Fatigue
- Nickel Chrome Plated to Resist Rust

Straight

SKU 081249 **14⁹⁹**
22621

45°
SKU 081250 **14⁹⁹**
22622

Duck Bill
SKU 213108 **9⁹⁹**
22644



(Color May Vary)

11" Hose Gripper Pliers Set (3 Piece)

SKU 94811 **34⁹⁹**
L311L

- Sizes: 5/16", 1/2" and 3/4" Constructed with Durable Drop Forged Steel
- Specialized Jaw will Securely Grip Cooling System, Fuel and Vacuum Lines without Damaging the Hose
- Heavy Duty Double-Dipped Synthetic Grip Handles to Minimize Slippage and Reduce User Fatigue
- Chrome Plated to Resist Rust

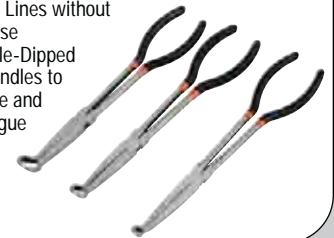

Mechanic's Pliers

- Precision-Machined Jaws Provide Improved Grip
- TecReady Grip Handles Reduce User Fatigue
- Nickel Chrome Plated to Resist Rust

OEM TOOLS®

Diagonal Pliers



Groove Joint Pliers



Linesman Pliers



Long Nose Pliers with Side Cutter



SKU	Part #	Type	Size	Color	Price
081240	22614	Diagonal	6-1/2"	Green	9.99
081241	22615	Diagonal	7-1/2"	Red	9.99
081245	22617	Groove Joint	6"	Red	16.99
081246	22618		8"	Red	18.99
081247	22619		10"	Red	19.99
081248	22620		12"	Red	21.99
081252	22624		16"	Red	34.99
081243	22616	Linesman	8"	Red	19.99
081237	22612	Long Nose Pliers with Side Cutter	6"	Red	9.99
081239	22613		8"	Red	9.99

X-Type Pliers

OEM TOOLS®

2 Piece 13" Long Nose Pliers Set

SKU 213127 **34⁹⁹**
22632

- Includes: 45° and Straight Extended Reach Pliers

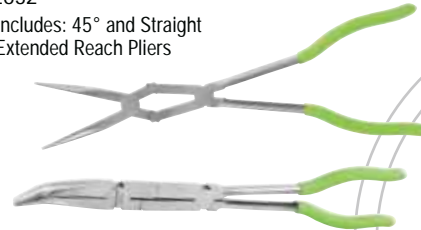

34⁹⁹
REG. \$39.98
SAVE \$4 OVER

When You Buy the Set

13" Long Nose Pliers

- Serrated Jaws for Precision Gripping

Straight

SKU 213135 **19⁹⁹**
22633

45°

SKU 213117 **19⁹⁹**
22634



Prices subject to change without notice. Prices do not include applicable taxes, vehicles, tires, rims, installation or optional equipment as shown. Please do not return purchases to the store. For information regarding warranty, repair, or any questions or concerns, call 901-300-4878.

AZG0425

137

HAND TOOLS

Punch Set

OEM TOOLS®

16 Piece Punch and Chisel Set
SKU 914624 25515 **29⁹⁹**

- Includes: 5 Taper Punches, 5 Pin Punches, 2 Center Punches, 3 Cold Chisels and 1 Chisel Gauge

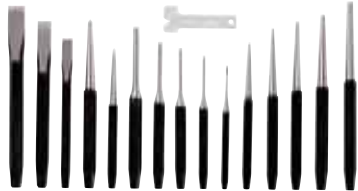

Pry Bars

3 Piece Light Duty Smoothing/Prying Kit
SKU 004111 25084 **9⁹⁹**

- Pry Dashboard Parts and Vents without Damaging Interior
- Clean Crevices and Joints in Small Electronics
- Disassemble Key Fobs and Other Remotes
- Evenly Smooth Epoxy and Adhesives



3 Piece Pry Bar Set
SKU 626114 24433 **49⁹⁹**

- Lengths Included: 12", 18" and 24"
- 3 Sided Handle for Secure Grip and Comfort
- Solvent Resistant and Easy to Clean



Dead Blow Hammers

3 Piece Dead Blow Hammer Set
SKU 900804 25517 **29⁹⁹**

- Soft Rubber Handles for Non-Slip Grip
- Steel Shot Filled for More Force
- Non-Spark Material Used



36" Pry Bar

SKU 695126 24435 **34⁹⁹** REG. \$49.99

SAVE \$15

- Unique Ergonomically Designed 3-Sided Handle for Secure Grip and Comfort
- Handles Made with Hardened Resin That is Solvent Resistant and Easy-to-Clean
- Forged and Hardened 5/8 In. Square Stock for Incredible Strength



Offer Good Through December 31, 2025

Adjustable Wrenches

OEM TOOLS®

- Made with Special Alloy Steel, Heat-Treated
- Deep Marking for Easy Identification
- Nickel Chrome Plated Steel Won't Rust
- Flat Profile is Comfortable in Hands



SKU	Part #	Size	Price
081268	22650	4"	9.99
081269	22651	6"	11.99
081271	22652	8"	13.99
081273	22653	10"	14.99
081274	22654	12"	19.99
081297	22655	15"	34.99

Pipe Wrench

GreatNeck

- Precision Milled Moveable Jaws
- Perfectly Balanced



SKU	Part #	Material	Size	Price
965845	APW14	Aluminum	14"	24.99
965848	APW18		18"	34.99
972768	APW24		24"	49.99
965847	APW36		36"	99.99

Snap Ring Pliers

OEM TOOLS®

6-1/2" Heavy Duty Snap Ring Pliers Set
SKU 15929 25397 **26⁹⁹**

- Tapered Tips: 0.8 mm, 1.2 mm, 1.4 mm and 2.0 mm
- Spring-Loaded Handles
- Settings: Straight, 45° and 90°



Cutting and Scraping Tools

Folding Lock Back® Utility Knife with Blade Dispenser
SKU 1022296 25537 **14⁹⁹**

- Includes: Blade Dispenser with 50 Blades
- Extra-Wide Handle for Increased Comfort and Leverage



Premium Folding Lock Back® Utility Knife with Sheath

SKU 1142419 12818 **24⁹⁹**

- 3-1/2" Stainless Steel and Hardwood Handle
- Patented Quick-Change Mechanism
- Accepts All Standard Utility Blades
- Includes: 1 Blade and Leather Sheath with Pocket Clip



4 Piece Plastic Scraper Set

SKU 900802 25513 **24⁹⁹**

- Works Like a Chisel
- Will Not Scratch Paint
- Will Not Cause Sparks
- Can Be Used for Wheel Weight Removal

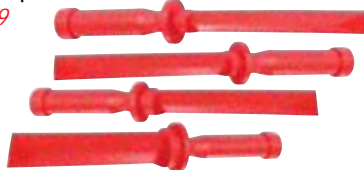

OEM TOOLS®



10" Utility Scissors

SKU 1142911 25085 **9⁹⁹**

- Super Hard Diamond-Like Carbon (DLC) Coating
- Stainless Steel Construction for Strength and Durability
- Bolt Lock Keeps Blades Secure
- Full Length Metal Frame Extends Through Handle for Added Strength



Scraper Kit
SKU 1282744 69004

- Includes: 2 Packs of Razor Blades (200) and 1 Razor Blade Scraper
- Perfect for Removing Paint and Decals



OEM TOOLS®

24⁹⁹ REG. \$43.97

SAVE OVER \$18
When You Buy the Kit

Moab Auto Emergency Folding Pocket Knife

SKU 1142700 12870 **14⁹⁹**

- 3-5/16" Partially Serrated Stainless Steel Blade, 4-1/2" Folded
- One-Handed Opening Mechanism
- Liner Lock
- Glass Breaker
- Belt Cutter
- Pocket Clip
- 4.5 Oz.
- Lifetime Warranty



SHEFFIELD®

SHEFFIELD®

HAND TOOLS

TO ORDER, contact your Commercial Sales Manager or go to AutoZonePro.com

HAND TOOLS

Precision Drivers

- Precision Driver Sets for Electronics and Applications in Tight Spaces
- Magnetic Tips to Secure Fasteners
- Constructed with Durable Chrome Vanadium Steel

7 Piece Metric Nut Driver Set

SKU **1282732** **24⁹⁹**
22562

- Includes: 3.0, 3.5, 4.0, 4.5, 5, 5.5 and 6.0 mm

7 Piece Metric Hex Driver Set

SKU **1282731** **24⁹⁹**
22563

- Includes: 0.7, 0.9, 1.3, 1.5, 2.0, 2.5 and 3.0 mm



6 Piece Precision Screwdriver Set

- Constructed with Durable Chrome Vanadium Steel

Star Screwdriver Set

SKU **003763** **12⁹⁹**
22559

- Set Includes: T5, T6, T7, T8, T9 and T10

Screwdriver Set

SKU **003751** **12⁹⁹**
22560

- Slotted Screwdrivers: (1.4, 2, 2.4 and 3 mm)
- Phillips Screwdrivers: (#0 and #1)

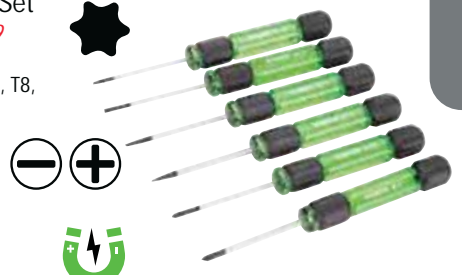

Magnetic Tips to Secure Fasteners

Pick Sets

4 Piece 14" Jumbo Pick Set

SKU **094658**
25940

39⁹⁹

- Includes: Straight, 90°, Offset and Hook Pick

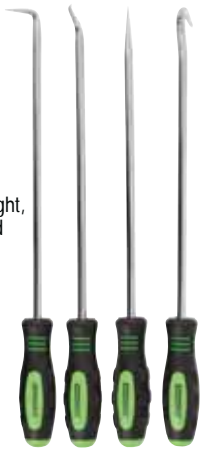

8 Piece Combination Hook and Pick Set

SKU **1168660** **24⁹⁹**
68913

- Set Includes: 4 Pc. 8" Hook and Pick Set with Acetate Handle and 4 Pc. 6" Mini Hook and Pick Set with Cushion Grip



6 Piece 8" Hook and Pick Set

SKU **1207883** **19⁹⁹**
26545

- Set Includes: 1 Hook Pick, 1 Complex Pick, (1) 90° Pick, 1 Combination Pick, 1 Double Angle Pick, 1 Straight Pick



8 Piece 10" Cushion Hook and Pick Set

SKU **1207881** **14⁹⁹**
26526

- Set Includes: Hook Pick, 90° Pick, 45° Pick, Double Angle Pick, Complex Pick, Angle Hook Pick, Combination Pick and a Straight Pick



Safety Wire Pliers



Reversible Wire Twister Pliers

Includes: 10 Meter x 0.5 mm Wire

- Heavy Duty Construction with Automatic Spring Return
- Reversible Action for Left and Right Twists
- Locking Jaws for Superior Wire Twisting
- Forged High Carbon Diamond Grooved Jaws to Cut and Grip Stainless Wire



SAVE \$65

9" SKU **1362002** **84⁹⁹**
22662

6" and 9" SKU **1282746** **22663**

6" SKU **1282736** **84⁹⁹**
22661

99⁹⁹
REG. \$164.99

Offer Good Through December 31, 2025

Hack Saw

Professional Hack Saw

SKU **1142352** **14⁹⁹**
74007

SAVE \$10

- Includes (1) 12" 24 TPI Bi-Material Blade
- High Tension Blade Prevents Twisting to Ensure Straight, Fast Cut
- Ergonomic Comfort Grip on Front Frame and Handle Provides Two-Handed Control



GreatNeck

Tension Control Provides Easy Adjustment When Changing Blades

Offer Good Through December 31, 2025

Bolt Cutters

Bolt Cutters

- Forged S2 Steel Construction for Cutting Power
- Hardened Cutting Edge for Long Life
- Ergonomic Comfort Grip Handles
- Limited Lifetime Warranty



GreatNeck

18" Bolt Cutters

SKU **OSB** **24⁹⁹**
BC18

For OSB, Call 901-300-4878

24" SKU **025213** **29⁹⁹**
BC24

30" SKU **965828** **39⁹⁹**
BC30

36" SKU **965827** **54⁹⁹**
BC36

Specialty Wrenches



Adjustable Gland Nut Wrench

- For Hydraulic Cylinders with Gland Nuts
- Reversible Design



SKU **1207900** **29⁹⁹**
27398

- Range: 1" to 3.75"
- Pin Size: 7/32" and 1/4"
- Drive: 1/2"

SKU **1340231** **39⁹⁹**
27397

- Range: 2" to 6"
- Pin Size: 1/4" and 5/16"
- Drive: 3/4"

Nut Drivers

7 Piece Professional Nut Driver Set

- Chrome Vanadium Steel for Strength and Durability
- Highest Quality Acetate Handle Stands Up to Abuse
- Color Coded for Easy Identification

Metric SKU **949001** **19⁹⁹**
ND71

- Sizes: 6, 7, 8, 9, 10, 11 and 12 mm

SAE SKU **949002** **19⁹⁹**
ND72

- Sizes: 3/16", 1/4", 5/16", 11/32", 3/8", 7/16" and 1/2"



GreatNeck

Prices subject to change without notice. Prices do not include applicable taxes, vehicles, tires, rims, installation or optional equipment as shown. Please do not return purchases to the store. For information regarding warranty, repair, or any questions or concerns, call 901-300-4878.

THREAD REPAIR

Ford Triton Repair Kits

Ford Triton 2 Valve Cylinder Repair Set

SKU **1268421** **369⁹⁹**
CAL38900

- Quality Foolproof Repair System That is Cost-Effective and Fast
- High-Quality Oversized Steel Alloy Insert Will Repair Other Inserts That Fail
- Application: 1996 to 2003 Ford 4.6L, 5.4L and 6.8L Engines



Ford 2 Valve Insert

SKU **1268420** **34⁹⁹**
CAL389-100

- Designed to Aid in Repairing 1996-2003 Two Valve Ford Modular Cylinder Heads
- High Quality Oversized Steel Alloy Insert Will Repair Other Inserts That Fail



Ford Triton 3 Valve Set

SKU **343388** **329⁹⁹**
CAL39300

- Application: 2004 to 2008 Ford 4.6 and 5.4 3 Valve Engines with Spark Plugs That are M16 x 1.5
- Includes 8 Inserts



M16 x 1.5 3 Valve Insert

SKU **396658** **24⁹⁹**
CAL393-100

- Note: this is NOT the Replacement Insert for the Triton 2 Valve Kit



Ford Triton Spark Plug and Electrode Repair Set

SKU **1268418** **99⁹⁹**
CAL39500

- Extracts the Broken Porcelain or Seized Sleeves from Broken Spark Plugs in 2003 to Current Ford Triton Engines



Ford Triton Plug-Saver® Kit

SKU **094873** **139⁹⁹**
FIX98140T

- Designed to Specifically Repair the Spark Plug Ports in 4.6, 5.4 and 6.8 Ford Triton Engines
- Repairs Worn, Damaged Threads
- Includes: Self Cutting Tap, Tool and 8 Inserts in a Sturdy Case



Inserts (Pack of 8)

SKU **110263** **59⁹⁹**
FIX98149P

FIX-A-THRED®

Broken Spark Plug Remover Ford Triton 3 Valve

SKU **489173** **129⁹⁹**
LIS65600

- Includes a Unique Porcelain Pusher Tool and a Tapered Left-Hand Thread Remover for Removing the Broken Spark Plug without Leaving the Porcelain in the Engine Cylinder



Lisle®

Oxygen Sensor Thread Repair

Oxygen Sensor Thread Repair Kit

SKU **010134** **169⁹⁹**
FIX38189-1

- No Need to Replace Exhaust Manifold
- Pilot Nose Tap Provided



FIX-A-THRED®

Wheel Stud Cleaner

Quick Change Wheel Stud Cleaner Kit

SKU **666299** **69⁹⁹**
CAL16

- Includes: 1/2" Drive Adapter and 6 Brushes
- Brush Sizes: 7/16" (12 mm), 1/2" (13 mm), 9/16" (14 mm), 5/8" (16 mm), 7/8" (22 mm) and 1-1/8" (28 mm)



Cal-Yan TOOLS

Head Bolt Thread Repair

Metric Head Bolt Thread Repair Kit

SKU **010131** **179⁹⁹**
FIX35119S

- Extended Reach for Deep Threads
- Longer Length (33 x 1.5 mm) Inserts for Maximum Thread Engagement
- Applications: Cadillac, Honda, Toyota and Other Imports That Use M11 x 1.5 Head Bolts



FIX-A-THRED®

Spark Plug Thread Repair

Spark Plug Thread Repair Kit - Metric M14 - 1.25

SKU **557108** **34⁹⁹**
25643

- Includes: High-Grade Tap, (3) Inserts and a Job-Specific Installation/Tang Break-Off Tool
- Returns Threads to Original Size
- Creates a Permanent and Wear-Resistant Thread



OEM TOOLS®

Tapered Seat Spark Plug Thread Repair Kit - Metric M14 - 1.25

SKU **OSB** **34⁹⁹**
25647

- 3 Insert Lengths are Provided to Fit the Most Common Spark Plug Reaches
- Positive Mechanical Locking Feature Keeps Insert in Place
- Piloted Reamer Eliminates Need to Drill Out Threads and Ensures Correct Alignment
- Can Be Used to Repair Both Taper Seat and Gasket-Type Spark Plug Assemblies
- Includes: 2-Step Piloted Reamer Tap, 3 Inserts and Swaging Tool



For OSB, Call 901-300-4878

THREAD REPAIR

TO ORDER, contact your Commercial Sales Manager or go to AutoZonePro.com

THREAD REPAIR

Spiral Bolt Extractor Sets

- Made of High-Quality Chrome Molybdenum Steel for Durability
- Grips and Removes a Wide Range of Stubborn Fasteners
- 3/8" Drive

Bites into Rusted, Rounded and Painted Over Nuts and Bolts



Specialized Spiral Design for a Secure Universal Grip on Nuts and Bolts

OEM TOOLS®

5 Piece Spiral Type Deep Extractor Set on Aluminum Rail

SKU 63893 22993 **38⁹⁹**

- Sizes: 3/8" (10 mm), 7/16" (11 mm), 1/2" (13 mm), 9/16" (14 mm) and 5/8" (16 mm)



5 Piece Spiral Type Extractor Set on Aluminum Rail

SKU 081304 22985 **34⁹⁹**

- Sizes: 5/16" (8 mm), 10 mm, 13 mm, 11/16" and 3/4" (19 mm)



10 Piece Spiral Type Bolt Extractor Set on Aluminum Rail

SKU 081788 22988 **49⁹⁹** REG. \$69.99 **SAVE \$20**

- Sizes: 5/16" (8 mm), 3/8", 10 mm, 7/16" (11 mm), 13 mm, 11/16", 1/2" (13 mm), 9/16" (14 mm), 3/4" (19 mm) and 5/8" (16 mm)



Offer Good Through December 31, 2025

Nut Busting Bolt Extractors

9 Piece (SAE) Nut Busting Bolt Extractor Socket Set

SKU 751720 22968 **24⁹⁹** REG. \$39.99 **SAVE \$15**

- High Visibility Markings for Fast, Easy Socket Selection
- Chrome-Molybdenum Steel Construction for Maximum Durability
- 3/8" Drive
- Includes: 1/4", 5/16", 3/8", 7/16", 1/2", 9/16", 5/8", 11/16" and 3/4"



Specialized Design for a Secure Universal Grip



Offer Good Through December 31, 2025

Drain Plug Repair

Drain Plug Repair Kit

SKU 818569 CAL38400 **99⁹⁹**

- Designed to Repair Aluminum Oil Pans with Damaged Drain Plug Threads, Size M12 x 1.75 Commonly Found in GM, Ford and Mazda Vehicles
- Includes: Drill, Counter Bore, Tap, Driver, Guide and (5) 12 mm Inserts
- Allows Use of OEM Plug Instead of an Oversize Replacement



Oil Pan Rethreading Kit

SKU 751709 LIS58850 **149⁹⁹**

- Oil Pan Plug Rethreading Kit Works on Steel or Aluminum Pans 1/2", 12 mm and 14 mm Threads



Axle Spindle Thread Repair

Axle Spindle Threading Set

SKU 1103645 37233 **49⁹⁹** REG. \$84.99 **SAVE \$35**

- Used to Clean or Repair Axle Threads
- Set Comes with a Special Twist Shape That Provides Easier and Quicker Work
- Sizes Included: M20 x 1.25, M20 x 1.50, M22 x 1.00, M22 x 1.50, M24 x 1.50, M24 x 2.00, 13/16" x 20 UNEF, 3/4" x 20 UNEF and 27 mm Extension Bar

Offer Good While Supplies Last Through December 31, 2025



Tap Sockets

8 Piece Tap Socket Set

SKU 1544666 24750 **39⁹⁹**

- Designed to Fit All Standard Taps Up to 1/2"
- Compatible with 1/8" NPT Taps and Metric Taps Up to 12 mm
- Perfect for Use in Tight Spaces Where a T-Handle Cannot Fit



Screw Extractor Bit Sets

6 Piece Spiral Flute Screw Extractor Set

SKU 099277 24374 **14⁹⁹**

- Extractors: Ex-1, Ex-2, Ex-3, Ex-4, Ex-5 and Ex-6
- Comes in a Vinyl Pouch



10 Piece Spiral Extractor and Drill Bit Combo Pack

SKU 099229 24373 **19⁹⁹**

- Extractors: Ex-1, Ex-2, Ex-3, Ex-4 and Ex-5
- Left Hand 135° Split Point Cobalt Drill Bit Sizes: 5/64", 7/64", 5/32", 1/4" and 19/64"
- Pilot Point Starts on Contact and Eliminates Bit Walking
- Comes in a Vinyl Pouch



10 Piece Multi-Spline Screw Extractor Set

SKU 099281 24375 **29⁹⁹**

- Sizes 1/8" to 13/32" (1/32" Increments)
- Can Be Used with Hand Sockets and Wrenches
- Aggressive Left Hand Spiral Design Provides Extra Gripping Power
- Designed to Prevent Extractor from Entering too Deeply and Expanding Screw
- Comes in a Foam-Lined Metal Case



35 Piece Master Screw Extractor/Drill Bit Set

SKU 099258 24377 **69⁹⁹** REG. \$99.99 **SAVE \$30**

- Spiral and Multi-Spline Extractors for Removing the Toughest Bolts and Screws from 3/32" to 15/16"
- 135° Split Point Left Hand Cobalt Drill Bits
- Comes in a Foam-Lined Metal Case



Offer Good Through December 31, 2025

4 Piece Damaged Screw Extractor Set

SKU 081310 25158 **9⁹⁹**

- Used to Quickly Remove Stripped, Broken and Painted Over Screws
- Will Work with Phillips, Flathead, Hex and Other Common Screws



Prices subject to change without notice. Prices do not include applicable taxes, vehicles, tires, rims, installation or optional equipment as shown. Please do not return purchases to the store. For information regarding warranty, repair, or any questions or concerns, call 901-300-4878.

SHOP SUPPLIES

Service Center Consumables

Start-Up Kit (Dispenser and Product)

SKU 262544
SNGMFKP994376

679⁹⁹

- Kit Includes:
- 250 Seat Covers
- 250 Paper Floor Mats
- 500 Plastic Floor Mats
- 500 Parts Bags
- 100 Tire Bags
- 1 Metal Floor Rack
- 1 Sign



Plastic Write On Key Tag (1,000 Count)

- Self Locking Plastic Key Tags Help Secure Keys

29⁹⁹

White
SKU 262547
SNGMFBP993323

Yellow
SKU 1125859
SNGFBP993324

Blue
SKU 1125872
SNGFBP993398

Red
SKU 1125868
SNGFBP993399

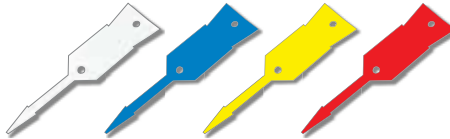

Paper Floor Mat (500/Box)

SKU 1544671
DOWPFM-500

64⁹⁹

- Durable Paper
- Measures 16" x 22"



Disposable Seat Cover

- 2-Layer Construction Keeps Cover in Place
- Refill for Start-Up Kit

Premium (250/Roll)

SKU 262537
SNGMFGP994314

119⁹⁹

- .7 Mil Thick with the Dimensions of 32" x 56" Dispensing Box

Value (500/Roll)

SKU 186487
SNGMFGP994315

139⁹⁹

- .5 Mil Thick with the Dimensions of 32" x 52"



Available in .7 and .5 Mil Thickness

Steering Wheel Cover (500/Box)

SKU 186485
SNGMFBP994333

74⁹⁹

- Double-Band Design Ensures a Snug Fit and Easy Installation



Vehicle Not Included



Plastic Floor Mats (500/Box)

SKU 186488
SNGMFGP994302

74⁹⁹

- Roll Size: 16.5" x 21"
- Comes in Durable Self-Dispensing Box



Work Ticket Holder (25/Box)

- Durable Brass Grommet Increases Strength
- Accommodates Most Pre-Printed and Computer Generated Forms

Clear

SKU 698887
SNGFBP993302

74⁹⁹

- 10.5" x 14.5" Clear Front and Back

Clear/Black

SKU 1142449
SNGFBP993303

74⁹⁹

- 11" x 13" Clear Front and Black Back



Parts Bag 11" x 17" (500/Case)

SKU 262541
SNGMFGP994330

49⁹⁹

- High Strength Protection
- Impervious to Most Shop Chemicals



Price Does Not Include Parts Shown



Adhesive Floor Mats (175/Roll)

SKU 262546
SNGMFBP993349

129⁹⁹

- Self Adhesive, 3 mil Protective Film Keeps Carpet Protected



Oil Change Printer and Labels

Thermal Oil Change Sticker Printer Kit

SKU OSB
SNGFKGX00106

699⁹⁹

- Kit Includes: Printer, Keyboard, Power Cord/Adapter, 1 Ink Ribbon and 2 Rolls of 500 Generic Static Cling Labels



Static Cling Refill Kit

SKU 291380
SNGMFKG016501

139⁹⁹

- 2 Rolls of Labels
- 1 Replacement Ribbon
- Fits Thermal Oil and Static Cling Printers

For OSB, Call 901-300-4878

Red Oil Can Service Reminder Labels

SKU 1405960
SNGFB-P993345

39⁹⁹

- Replacement Roll of 500 Labels



Blue Wrench Service Reminder Labels

SKU 1407511
SNGFB-P993394

39⁹⁹

- Replacement Roll of 500 Labels



Hand Cleaner



Starter Kit with Dispenser

SKU 972773
24292

64⁹⁹

- Kit Includes: Wall-Mount Dispenser and 4,000 mL of Cherry Fragrance Cleaner
- All Natural, Concentrated, Solvent Free Cleansing Formula
- Unique Skin Conditioning System Leaves Hands Feeling Smoother, While Fibril Scrubbers Deep Clean Even the Toughest Dirt
- 100% Biodegradable



4000 mL Refill Bottle

SKU 972772
24291

44⁹⁹

Creepers

Workshop Seat and Step Stool

SKU 1189077 24904 **89⁹⁹** REG. \$114.99

SAVE \$25

- Combination Step Stool and Creeper Seat That Allows Additional Maneuverability
- Thick Padding Covered with Durable Vinyl Provides Comfort While Working
- Includes a Tool Tray for Organization and Convenience
- 4 Swivel Casters Made for All Terrain
- Weight Capacity: 300 Lb.
- 18"(L) x 16"(W) x 7"(H)



Offer Good Through December 31, 2025

Sidekick Creeper Seat

SKU 1168662 24987 **124⁹⁹** REG. \$164.99

OEM TOOLS

- Large Open Tray to Carry a Wide Range of Items with Additional Holster Caddies on the Side for Rapid Access to Most Used Items
- Slide Out Under Seat Drawer Can Be Used to Store and Organize Tools
- Weight Capacity: 330 Lb.

SAVE \$40



Offer Good Through December 31, 2025

Heavy Duty Rolling Workbench and Creeper Seat

SKU 1142423 24986 **89⁹⁹**

OEM TOOLS

- Molded Seat and Frame Provide Durable Support
- Removable Clip-In Trays for Storage and Easy Transport of Parts and Tools
- Trays Feature Screwdriver Storage Holes for Easy Organization
- Weight Capacity: 300 Lb.



Cushioned Creeper Seat with Tool Tray

SKU 757019 24948 **64⁹⁹**

OEM TOOLS

- Tool Tray Dimensions: 11-1/2" x 12-1/2"
- Cushioned Seat
- 4 Swivel, Oil-Resistant Wheels
- Weight Capacity: 330 Lb.



Mechanics Creepers with Headrest

- Made with HDPE Plastic and Molded for Comfort to Ensure a Quick and Accurate Job
- Easy to Handle, Lift and Store
- 6 Swivel Casters Able to Maneuver All Terrain
- Casters are 3" in Diameter for Additional Durability and Product Longevity
- Weight Capacity: 350 Lb.

40" SKU 1189063 24909 **54⁹⁹** REG. \$79.99

SAVE \$25

- Light Weight 13.2 Lb.
- 40"(L) x 19"(W)

36" SKU 1189084 24977 **49⁹⁹** REG. \$69.99

SAVE \$20

- Light Weight 9 Lb.
- 36"(L) x 18"(W)



Offers Good Through December 31, 2025

Workshop Creeper Seat with 2 Drawers - Blue

SKU 542531 24996 **89⁹⁹**

OEM TOOLS

- Padded Seat for Maximum Comfort
- 2 Sliding Drawers
- Can Holder for 3 Cans
- Smooth Rolling Wheels
- Weight Capacity: 280 Lb.



ProGear Race Seat, Green/Black

SKU OSB TRX2-705 **179⁹⁹**

TRAXION
engineered products

- Tray Spins for Easy Access to Tools and Parts
- Adjustable Seat Height: 13-1/2" to 17-1/2"
- Five Spoke Frame is OSHA Compliant



For OSB, Call 901-300-4878

Professional 41" 6 Wheel Creeper

SKU 125749 24970 **194⁹⁹**

OEM TOOLS

- 3D Streamline Design for Shoulder Clearance
- 6 Heavy Duty TPU Casters
- Low Ground Clearance Allows for Greater Mobility
- 4 Tool Storage Trays
- Weight Capacity: 300 Lb.



Topside Creepers

Topside Creeper

SKU OSB TRX3-100 **379⁹⁹**

TRAXION
engineered products

- Height Adjusts from 48" to 64"
- Weight Capacity: 400 Lb.



For OSB, Call 901-300-4878

Work Stand

Pro Step Adjustable Work Stand

SKU 222856 279⁹⁹ STK20350

STECK

- 500 Lb. Capacity
- Height Adjustable from 6-1/2" to 22-1/2"
- 32" x 16"



Truck Tire Step

SKU 818571 24913B **69⁹⁹** REG. \$99.99

OEM TOOLS

SAVE \$30

- Fits Both Front and Rear 9" to 13" Wide Tires
- Powder Coat Finish
- Designed for SUVs, Motor Homes and Light Duty Trucks
- Heavily Textured Non-Slip Step for Safety
- Adjustable Rubber Bumpers Protect Your Wheels and Ensure the Step is Sturdy and Level
- Easy to Adjust
- Weight Capacity: 300 Lb.



Offer Good Through December 31, 2025

SHOP SUPPLIES

Workshop Stools

Adjustable Hydraulic Shop Stool
SKU 751712
24912

SAVE \$15

149⁹⁹ REG. \$164.99

- Vinyl Padded Swivel Seat for Comfort
- Chrome Footrest
- Powder Coated Legs



Adjustable Height: 28" to 32-1/2"



300 Lb. Weight Capacity



360° Rotating Seat

Offer Good Through December 31, 2025

Double Ring Adjustable Stool with Backrest
SKU 1580968
25700

89⁹⁹

- 360° Swivel Seat
- Durable Vinyl Seat and Back Rest Cushion
- Matte Black Finish
- Adjustable Height
- Weight Capacity: 300 Lb.



Adjustable Height



Vinyl Padded, 360° Swivel Seat

Swivel Stool with Double Ring
SKU OSB 25701

59⁹⁹

- Thick 5" Foam Cushion
- 360° Swivel Seat
- Durable Vinyl Seat
- Matte Black Powder-Coated Frame

OEM TOOLS®



Double Ring Design Offers Added Stability and Footrest Support



Double Ring Design



Vinyl Padded, 360° Swivel Seat

For OSB, Call 901-300-4878

Fender Covers

Fender Cover
SKU 965832
24900

24⁹⁹

- Heavy Gauge Vinyl Wipes Clean
- 27" x 34"



Soft Fleece Fender Cover
SKU 751711
24899

34⁹⁹

- Soft Fleece Fender Cover to Prevent Paint Damage
- 2 Super Powerful Corner Magnets for Securing the Cover in Place
- Magnets are Removable to Wash the Cover
- Large 42" x 24" Size for Cars, Trucks and SUVs

OEM TOOLS®



Magnetic Nut Cups

Multicolor Magnetic Nut Cup Assortment (4 Pack)
SKU 1282743
68939

39⁹⁹

- Holds Bolts, Nuts and Parts to Speed Up Work and Eliminate Misplacing Parts
- Coated Magnet Sticks to All Ferrous Metal Work Surfaces
- Includes: 1 Green Cup, 1 Red Cup, 1 Orange Cup, 1 Blue Cup

OEM TOOLS®



Strong Magnets Attach the Cups Securely to Most Flat Metal Surfaces

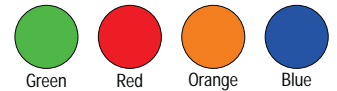

CRC SmartWasher®
BIOREMEDIATING parts washing system

A SMARTER & SAFER SOLUTION

The CRC SmartWasher® is a manual parts washer that replaces traditional solvent or aqueous alternatives.

- Bioremediation Technology
- Powerful Cleaning Performance
- No Hazardous Waste Generation
- Lower Operating Cost

Product	Part #	Price
SmartWasher SW-723 Kit*	14743	\$2699.00
OzzyJuice® SW-7	14721	\$211.99
OzzyMat® FL-4	14124	\$31.99

*1 SW-23 SmartWasher® Unit, 3 5-Gallon jugs of OzzyJuice® SW-7 Parts/Brake Cleaning Solution, and 1 FL-4 OzzyMat® Multi-Layer Fluid Activation Mat

Check out our YouTube channel here



crcindustries.com/smartwasher

<p>Hardware and Service Parts HARDWARE MACHINERY</p> <p>96 Piece Mini Fuse Kit SKU 271169 19⁹⁹ 68148</p> <ul style="list-style-type: none"> Includes: Mini Fuses 3A to 30A 	<p>96 Piece ATO Fuse Assortment HARDWARE MACHINERY SKU 271172 19⁹⁹ 68149</p> <ul style="list-style-type: none"> Includes: ATO Fuses 3A to 30A 	<p>24 Piece Maxi Fuse Assortment HARDWARE MACHINERY SKU 271152 19⁹⁹ 68146</p> <ul style="list-style-type: none"> Includes: Maxi Fuses 20A to 100A 
<p>200 Piece Spring Assortment HARDWARE MACHINERY SKU 271195 9⁹⁹ 68140</p> <ul style="list-style-type: none"> Includes: 20 Popular Sizes from 7/32" x 11/16" to 5/16" x 1-1/4" 	<p>Universal O-Ring Set HARDWARE MACHINERY</p> <p>407 Piece (SAE) 419 Piece (Metric) SKU 546661 24⁹⁹ SKU 546659 24⁹⁹ 68168 68167</p> <ul style="list-style-type: none"> Inside Diameters from 1/8" to 2" Inside Diameters from 3 mm to 50 mm 	<p>270 Piece A/C O-Ring Kit HARDWARE MACHINERY SKU 271196 19⁹⁹ 68141</p> <ul style="list-style-type: none"> Contains 270 O-Rings in a Variety of SAE Sizes Great O-Ring Set for Most Automotive and Refrigerant Applications 
<p>110 Piece Copper Washer Assortment HARDWARE MACHINERY SKU 271176 14⁹⁹ 68117</p> <ul style="list-style-type: none"> Includes: Popular Sizes M6 to M16 	<p>115 Piece Master Brake Line Fitting Assortment Kit JohnDew Dynamic SKU 082943 139⁹⁹ DOWDY-BLF-5</p> <ul style="list-style-type: none"> 23 Brake Line Fitting Variations Tube Nuts, Union, Brake Line Adapters 	<p>555 Piece Stainless Cotter Pin Assortment HARDWARE MACHINERY SKU 271183 24⁹⁹ 68121</p> <ul style="list-style-type: none"> Includes: 6 Popular Sizes from 1/16" x 1" to 5/32" x 2-1/2" 
<p>500 Piece Aluminum Rivet Assortment HARDWARE MACHINERY SKU 271150 9⁹⁹ 68109</p> <ul style="list-style-type: none"> Includes: 1/8" and 3/16" Rivets 1/4", 5/16" and 3/8" Long 	<p>80 Piece Vacuum Cap Assortment HARDWARE MACHINERY SKU 271197 19⁹⁹ 68129</p> <ul style="list-style-type: none"> Includes Sizes: 3/16" to 3/8" 	<p>34 Piece Hose Clamp Assortment HARDWARE MACHINERY SKU 271201 9⁹⁹ 68137</p> <ul style="list-style-type: none"> Includes Sizes: 5/8" to 1-1/4" 
<p>88 Piece Drain Plug and Gasket Assortment Kit JohnDew Dynamic SKU 617724 114⁹⁹ DOWDY-DPA-6</p> <ul style="list-style-type: none"> 18 Drain Plug Variations, 4 Gasket Variations Most Popular 12 mm and 14 mm Drain Plugs 	<p>240 Piece Master Drain Plug Gasket Assortment Kit JohnDew Dynamic SKU 606762 144⁹⁹ DOWDY-DGK-240</p> <ul style="list-style-type: none"> 24 Drain Plug Gasket Variations Aluminum, Copper, Crush, Fold-Over, Nylon, Rubber/Metal 	<p>120 Piece Oil Drain Plug Gasket Assortment SILRR SKU 1400041 34⁹⁹ SURDPG120</p> <ul style="list-style-type: none"> Covers Most Domestic and Import Cars and Light Trucks 120 Total Includes 24 Variations, 5 Each: Copper, Metal Crush, Nylon, Fiber and Rubber/Metal 
<p>76 Piece Oil Drain Plug Assortment SILRR SKU 662839 89⁹⁹ SURDP454</p> <ul style="list-style-type: none"> Includes: 76 Pieces with Corresponding Gaskets, 17 Direct Fit SKUs Includes: Labeled Case for Quick Identification and Organization Covers Most Domestic and Import Cars and Light Duty Trucks 	<p>60 Piece Wheel Lug Nut Assortment A JohnDew Dynamic SKU 082947 109⁹⁹ DOWDY-WN-12</p> <ul style="list-style-type: none"> 12 Lug Nut Variations Standard, Dome, Acorn Thread 	<p>Assortment B JohnDew Dynamic SKU 082948 159⁹⁹ DOWDY-WN-12B</p> <ul style="list-style-type: none"> Dome Acorn, Bulge, Flat-Capped, External Thread 

Prices subject to change without notice. Prices do not include applicable taxes, vehicles, tires, rims, installation or optional equipment as shown. Please do not return purchases to the store. For information regarding warranty, repair, or any questions or concerns, call 901-300-4878.

SAFETY & GLOVES

First Aid Kits

Safeguard Employees and Jobsites Through Injury Preparation with Multi-Functional First Aid Kits

First Aid Kits

- Wall Mountable Organized Durable Plastic Case
- Contains Essentials for Light Injuries and Wounds
- Meets ANSI/ISEA Z308.1-2021, Class A, Type I, II, III, or IV First Aid Kit

25-Person First Aid Kit
SKU **1442584**
SAS6025-025 **69⁹⁹**

100-Person First Aid Kit
SKU **765585**
SAS6099-100 **119⁹⁹**



SAS6025-25



SAS6099-100



Safety Supplies

Hi Vis Knit Beanie - Orange
SKU **687972**
SAS692-1711 **34⁹⁹**

- One Size Fits All
- Comfortable and Warm
- 100% Knit Polyester
- ANSI/ISEA 107 Compliant
- Reflective Knit Stripe



Hot Sleeve

SKU **291321**
LIS18700 **24⁹⁹**

- Protects Arms from Burns While Working Around the Engine
- Made of Durable, Heat-Resistant Kevlar
- Double Wall Construction for Added Heat Protection



Face Shield Clear

SKU **972271**
SAS5140 **29⁹⁹**

- Impact-Resistant Polycarbonate Shield
- Curved Lens Design
- Ratcheting Headpiece
- Meets ANSI Z87.1-2015



Ear Plugs

Foam Ear Plugs
SKU **526953**
SAS6100 **54⁹⁹**

- Noise Reduction Rating: 31
- 200 Individually Packaged Pairs
- Pre-Shaped Foam Earplugs



Safety Glasses

LED Safety Glasses
SKU **555987**
26039 **18⁹⁹**

- High-Impact Resistant Lens Protects Eyes
- Flexible, Lightweight and Padded Frames
- Meets ANSI Z87.1
- Includes: (8) LR41 Batteries

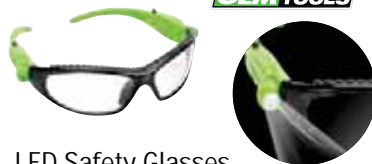

LED Safety Glasses (3 Pack)
SKU **592265**
26017PK3 **29⁹⁹**

NSX Turbo Safety Glasses

- High-Impact Polycarbonate Lens
- Safety Eyewear That Also Provides 99.9% UV Protection



Smoke
SKU **462983**
SAS5331PK **29⁹⁹**



Clear
SKU **301767**
SAS5330PK **29⁹⁹**



Amber
SKU **462984**
SAS5332PK **29⁹⁹**

- Scratch-Resistant Coating
- Single Lens Design
- Lightweight Wrap-Around Lens
- ANSI/ISEA Z87.1-2015 Compliant



STORE STOCKED

Advantage X300 Series Safety Glasses - Amber (12 Pack)

SKU **1149164**
JASS70711PK **19⁹⁹** REG. \$34.99

- Lightweight, Comfortable and Affordable
- Lens Features an Anti-Scratch Hard Coating
- Made Using Virgin, Unitary Polycarbonate Lenses

- 99.9% UV Protection
- Ideal for Construction, Shop and General Eye Protection Applications

SAVE \$15



Offer Good Through December 31, 2025



Multifocal Safety Reading Glasses

- Eye Protection and Multifocal Reading Glasses
- High Impact, Anti-Scratch Lenses Protect Your Eyes
- Fully Adjustable Temples for Comfort and Fit
- ANSI/ISEA Z87.1-2015 Compliant

24⁹⁹ each



+1.5	+2.0	+2.5	+3.0
SKU 752076	SKU 752077	SKU 752078	SKU 752086
26023	26024	26025	26026

Eyewash Stations

Emergency 9 Gallon Eyewash Station Wall Mount Gravity Fed

SKU **912344**
SAS5134-00 **319⁹⁹**

- Compliance - ANSI Z358.1-2014
- Portable Unit Measures 20.15" x 16.5" x 9.5"
- Includes: Mounting Bracket, Inspection Tag, Tamper Resistant Tie and Preservative

Eyewash Concentrate Solution

SKU **1142715**
SAS5136-01 **24⁹⁹**

- For Use with 9 Gallon Eyewash Station #SAS5134-00

Bottle Eyewash Station

SKU **094904**
SAS5132 **99⁹⁹**

- Includes: (2) 16 Oz. Eye Irrigate Solution Bottles
- Does Not Meet ANSI Z358.1

16 Oz. Eyewash Irrigate Refill

SKU **977588**
SAS5130 **29⁹⁹**

- For Use with Eyewash Station SAS5132



Detection Light

UV Leak Detection Light and Glasses

SKU **213144**
24516 **24⁹⁹**

- Compact UV Leak Detection Pen Light
- Yellow Lens Protective Glasses Enhance Visibility of Leaks
- Can Be Used with All Types of UV Leak Detection Dyes
- Includes: 2 AAA Batteries



2 AAA

SAFETY & GLOVES

TO ORDER, contact your Commercial Sales Manager or go to AutoZonePro.com

SAFETY & GLOVES

Raven Patriot Gloves



- 7 mil Powder-Free Exam Grade Nitrile
- Textured Fingertips
- Latex-Free



Find In Store, Right Now
29⁹⁹ per box

Large sku 1445914 | 66483

XL sku 1445911 | 66484



Compression Fit Technology



Environmentally Responsible



Supply Chain Resilient

Buy More, Save More

5 Boxes of 100 Each **119⁹⁹** ~~15.00~~ per box

Medium	sku	1525554		SAS66482-5PK
Large	sku	1525556		SAS66483-5PK
XL	sku	1525565		SAS66484-5PK
2XL	sku	1525560		SAS66485-5PK

10 Boxes of 100 Each **229⁹⁹** ~~12.00~~ per box

Medium	sku	1522380		SAS66482CS
Large	sku	1525553		SAS66483CS
XL	sku	1525561		SAS66484CS
2XL	sku	1525562		SAS66485CS

Raven Gloves



- 7 mil Powder-Free Exam Grade Nitrile
- Ambidextrous Textured Grip
- Latex-Free



Find In Store, Right Now
24⁹⁹ per box

Medium sku 435079 | 66517

Large sku 244622 | 66518

XL sku 244617 | 66519



Buy More, Save More

2 Boxes of 100 Each **39⁹⁹** ~~20.00~~ per box

Medium	sku	547964		SAS66517-2PK
Large	sku	547965		SAS66518-2PK
XL	sku	547966		SAS66519-2PK
2XL	sku	547963		SAS66520-2PK

5 Boxes of 100 Each **89⁹⁹** ~~18.00~~ per box

Medium	sku	1189346		SAS66517-5PK
Large	sku	1189328		SAS66518-5PK
XL	sku	1189339		SAS66519-5PK
2XL	sku	1442587		SAS66520-5PK

10 Boxes of 100 Each **164⁹⁹** ~~16.50~~ per box

Medium	sku	1190191		SAS66517CS
Large	sku	265052		SAS66518CS
XL	sku	265053		SAS66519CS
2XL	sku	1330682		SAS66520CS

Astro-Grip Gloves



- 7 mil Powder-Free Exam Grade Nitrile
- Embossed Cube Grip
- Latex-Free



Find In Store, Right Now
24⁹⁹ per box

Medium sku 823166 | 66472

Large sku 823167 | 66473

XL sku 823168 | 66474



Buy More, Save More

2 Boxes of 100 Each **49⁹⁹** ~~25.00~~ per box

Medium	sku	1330679		SAS66472-2PK
Large	sku	1330676		SAS66473-2PK
XL	sku	1331500		SAS66474-2PK
2XL	sku	1331496		SAS66475-2PK

5 Boxes of 100 Each **109⁹⁹** ~~22.00~~ per box

Medium	sku	1330686		SAS66472-5PK
Large	sku	1331480		SAS66473-5PK
XL	sku	1331488		SAS66474-5PK
2XL	sku	1331487		SAS66475-5PK

10 Boxes of 100 Each **209⁹⁹** ~~21.00~~ per box

Medium	sku	1330697		SAS66472CS
Large	sku	1331497		SAS66473CS
XL	sku	1331489		SAS66474CS
2XL	sku	1331494		SAS66475CS

Prices subject to change without notice. Prices do not include applicable taxes, vehicles, tires, rims, installation or optional equipment as shown. Please do not return purchases to the store. For information regarding warranty, repair, or any questions or concerns, call 901-300-4878.



FREE SHIPPING
WITH MOST ORDERS
SEE PAGE 2 FOR DETAILS

2025
OCT-DEC

Hablamos Español **Call 901-300-4878**

GREAT FINANCING PROGRAMS*

UNISOURCE 800-404-6792

NEWLANE 267-768-3228

PEAC 856-505-4450

1 LEASING COMPANIES

- Leases are handled by three companies
- Customer must:
 - Select equipment
 - Complete credit application
 - Receive approval from leasing company
- Once the transaction is approved and documents are signed by customer:
 - Customer invoice is funded by leasing company
 - Equipment order is placed

UniSource Capital
Never give up...Never Surrender!

NL NEWLANE
FINANCE
BUSINESS LENDING DONE RIGHT

PEAC
SOLUTIONS

2 30-60-90

- AutoZone® credit account in existence for 6 months
- Satisfactory payment history with AutoZone®
- Updated account application with agreement section completed and signed
- No NSF checks within 6 months
- No credit holds within 6 months
- Established credit worthiness
- Minimum down payment = 35%
- Minimum 52 wks. sales = \$15 K
- Minimum equipment cost = \$1 K (sales tax included)

3 EXTENDED TERMS

- AutoZone® credit account in existence for 1 year
- Satisfactory payment history with AutoZone®
- Updated account application with agreement section completed and signed
- No NSF checks within 6 months
- Established credit worthiness
- Minimum down payment = 35%
- Minimum 52 wks. sales = \$25 K
- Minimum equipment cost by term:
 - 6 months \$3 K
 - 9 months \$6 K
 - 12 months \$8 K or greater (financial statement may be required)

* Financing is provided by third parties who are not affiliates of AutoZone. All of the advertised loan programs, rates, terms and conditions are subject to change at any time without notice. An extra charge may be imposed at the end of the lease depending on the residual value of the leased goods. Free overnight shipping available to continental U.S. for qualifying VDP orders of 70 lb. or less. Free overnight shipping excludes: liftgate fees, residential delivery, non-network carriers, and certain freight intensive items that are shipped FOB.

©2025 GreatNeckTools, Inc. Certain content provided by and is the property of AutoZone Parts, Inc. All rights reserved. AutoZone, AutoZone & Design, Loan A Tool, Duralast, Duralast Gold, Duralast Proven Tough and Duralast ProPower are registered marks of AutoZone IP LLC or one of its affiliates. All other marks are the property of their respective holders. iPhone® and iPad® are registered trademarks of Apple Inc., Android® is a trademark of Google Inc., STP® is a registered trademark of the Energizer Auto, Inc., and Bluetooth® is a trademark of Bluetooth® SIG, Inc. Items requiring freight shipping cannot be delivered outside of the continental United States. For shipping cost to Alaska or Hawaii, please contact Commercial Sales Manager. Ad prices cannot be combined with any other offer. Offers may vary by market. Offers valid while quantities last. Items may not be available at all locations at all times. We reserve the right to limit quantities and to correct pricing errors. Some new items might not be available at the time of print deadline. Prices valid only during sales catalog effective dates. All photographic, clerical, typographical and printing errors are subject to correction. Images shown may not be actual product but represent products or sets which include product. We reserve the right to substitute a like item or an item of greater value on any promotional offer in this publication. Store stock items may be purchased at any local AutoZone store or through your AutoZone Commercial Sales Manager. Bonus items are fulfilled while supplies last and may ship separately. Bonus items may be replaced with like items of the same or greater value.

AZG0425 | SKU 1391460 \$2.99